





**NAVAL FACILITIES ENGINEERING COMMAND  
PUBLICATIONS TRANSMITTAL**

SN 0525-LP-300-7056

))0))))))))))))0))

1. TITLE	* NUMBER	* DATE
DM-7.01 SOIL MECHANICS	* Change 1	* September 1986

))2))))))))))))2))

2. ATTACHMENTS	
New Cover	New pages 7.1-159 through 7.1-162.
New Record of Document Changes page.	New pages 7.1-175 and 7.1-176.
New pages iii through xv.	New pages 7.1-203 and 7.1-204.
New pages 7.1-1 and 7.1-2.	New pages 7.1-259 and 7.1-260.
New pages 7.1-45 through 7.1-50.	New pages 7.1-283 and 7.1-284.
New pages 7.1-115 through 7.1-118.	New page 7.1-307.
New pages 7.1-125 through 7.1-126.	New pages 7.1-345 and 7.1-346.
New pages 7.1-153 through 7.1-154	New pages 7.1-A-1 and 7.1-A-2.
	New DD Form 1426.

))

3. EXPLANATION

Remove old cover dated May 1982, and replace with attached new cover dated September 1986.  
 Insert new Record of Document Changes pages immediately after new cover page.  
 Remove pages 7.1-iii through 7.1-xviii and replace with new pages iii through xv.  
 Remove pages 7.1-1 and 7.1-2 and replace with attached new pages 7.1-1 and 7.1-2  
 Remove pages 7.1-45 through 7.1-50 and replace with attached new pages 7.1-47 through 7.1-50.  
 Remove pages 7.1-115 through 7.1-118 and replace with attached new pages 7.1-115 through 7.1-118.  
 Remove pages 7.1-125 through 7.1-126 and replace with attached new pages 7.1-125 through 7.1-126.  
 Remove pages 7.1-153 and 7.1-154 and replace with attached new pages 7.1-153 and 7.1-154.  
 Remove pages 7.1-159 through 7.1-162 and replace with attached new pages 7.1-159 through 7.1-162.  
 Remove pages 7.1-175 and 7.1-176 and replace with attached new pages 7.1-175 and 7.1-176.  
 Remove pages 7.1-203 and 7.1-204 and replace with attached new pages 7.1-203 and 7.1-204.  
 Remove pages 7.1-259 and 7.1-260 and replace with attached new pages 7.1-259 and 7.1-260.  
 Remove pages 7.1-283 and 7.1-284 and replace with attached new pages 7.1-283 and 7.1-284.  
 Remove page 7.1-307 and replace with attached new page 7.1-307.  
 Remove pages 7.1-345 and 7.1-346 and replace with attached new pages 7.1-345 and 7.1-346.  
 Remove pages 7.1-A-1 and 7.1-A-2 and replace with attached new pages 7.1-A-1 and 7.1-A-2.  
 Insert new DD Form 1426 in back of manual.

DM-7.01 SOIL MECHANICS is revalidated for three years after incorporation of this change.

))

4. DISTRIBUTION

See reverse.

))

NAVFAC DM/P MANUAL DISTRIBUTION (01/87):  
(1 copy each unless otherwise specified)

SNDL

39B COMCB  
49 ADMSUPPU  
A2A NAVY STAFF (ONR only)  
A3 CHIEF OF NAVAL OPERATIONS  
A5 NAVPERS & BUMED  
A6 COMMANDANT MC (code LFF)  
B2A (JCS, NSA, DLA, DNA only)  
B5 USCG only)  
E3A LAB ONR(Wash.DC only)  
FA6 NAVAIRSTA LANT  
FA7 NAVSTA LANT  
FA10 SUB BASE LANT  
FA18 PHIBASE LANT  
FA23 NAVFAC LANT  
FA32 CINCLANT CBU  
FB6 NAVAIRFAC PAC  
FB7 NAVAIRSTA PAC  
FB10 NAVSTA PAC (Seattle only)  
FB13 SUBBASE PAC (Bangor only)  
FB21 PHIBASE PAC  
FB34 FLEACTPAC (Kadena, Sasebo only)  
FB36 FAC PAC  
FB48 SUPPFAC PAC  
FC3 ACTIVITY EUR (London only)  
FC5 SUPPORT ACTIVITY EUR  
FC7 NAVAL STATION EUR  
FC12 FLEET SUPPORT OFFICE  
FC14 NAVAIRSTA EUR  
FD1 OCEANOGRAPHY COMM  
FE1 SECURITY GROUP HQ  
FE2 SECURITY STATION  
FE4 SECGRUACT (Edzell, Hanza  
Homestead, Sabana Seca,  
Sonoma, Winter Harbor only)  
FF6 NAVAL OBSERVATORY  
FF38 NAVAL ACADEMY  
FG1 TELECOMCOM  
FG2 COMSTA (Balboa, Harold Holt,  
Nea Makri, Thurso, Stockton,  
Yokosuka, San Miguel only)  
FG3 COMM UNIT (East Machias only)  
FG6 CA MASTER STAS (Norfolk only)  
FH1 COMNAVMEDCOM  
FKA1A SYSCOM, AIR  
FKA1B SYSCOM, ELEX  
FKA1C NAVFAC, (Code 04M2, 30 copies)  
FKA1F SYSCOM, SUP  
FKA1G SYSCOM, SEA  
FKM8 SUPPLY ANNEX  
FKM9 NSC (Oakland only)  
FKM13 SHIPS PARTS & CONTROL CEN  
FKM15 ASO (Philadelphia only)  
FKN1 LANTDIV (100 copies)  
CHESDIV ( 50 copies)  
NORTHDIV (75 copies)  
PACDIV, SOUTHDIV,  
WESTDIV, (200 copies each)  
FKN2 CBC

FKN3 OICC (6 copies each)  
 FKN5 PWC (5 copies each)  
 FKN7 ENERGY ENVIRON SUPP ACT  
 FKN10 SUPPORT ACT, NAV FAC  
 FKN11 CIVIL ENGINEERING LAB  
 FKP1B WEAPONS STATION  
 FKP1E UNDERSEA WARFARE ENGR STA  
 FKP1J NAVAL ORDNANCE STATION  
 FKP1M WEAPONS SUPPLY CENTER  
 FKP7 NAVAL SHIPYARDS  
 FKQ3A ELECTRONIC STMS ENGR CEN  
 FKQ6A AIR DEVELOPMENT CENTER  
 FKQ6B COASTAL SYSTEMS CENTER  
 FKQ6C OCEAN SYSTEMS CENTER  
 FKQ6E SHIP RESEARCH & DEV.CEN.  
 FKQ6F SURFACE WEAPONS CENTER  
 FKQ6G UNDERWATER SYSTEMS CENTER  
 FKQ6H NAVAL WEAPONS CENTER  
 FKR1A AIR STATIONS R & D  
 FKR1B AIR REWORK FACILITY  
 FKR3A AIR ENGINEERING CENTER  
 FKR3H AIR PROPULSION CENTER  
 FKR4B MISSILE RANGE FACILITY  
 FKR5 AVIONICS CENTER  
 FKR7E AVIATION LOGISTICS CENTER  
 FR3 AIR STATIONS  
 FR4 AIR FACILITIES  
 FR15 SUPPACT  
 FT1 CHIEF NAVAL ENGR. TRAINING  
 FT2 CHIEF NAVAL AIR TRAINING  
 FT6 AIR STATIONS CNET  
 FT13 AIR TECH TRAINING CEN  
 FT18 CONSTR. BATTALION UNIT CBC  
 FT19 ADMINCOM (San Diego only)  
 FT22 FLECOMBATRACEN (Va. Beach only)  
 FT28 EDUCATION & TRAINING CEN  
 FT31 TRAINING CENTER  
 FT37 SCHOOL CEC OFFICERS  
 FT55 SCHOOL SUPPLY CORPS  
 FT78 ED & TRNG PGM DEV CEN  
 V2 MARCORPS BARRACKS SUPPORT  
 V3 NC AIR BASE COMMAND  
 V5 MCAS (less Beaufort)  
 V5 MCAS (Beaufort only,5 cys)  
 V8 MC RECRUIT DEPOT  
 V12 MC DEVELOP.& EDUCATION CEN  
 V14 MC HEADQUARTERS BATTALION  
 V15 MC DISTRICT  
 V17 MC CAMP  
 V23 MC LOGISTICS BASE  
 V25 MC AIR GROUND COMBAT CEN

REMAINDER TO: RECEIVING OFFICER  
 Naval Publications and Forms Center  
 5801 Tabor Avenue, Phila., PA 19120  
 FOR IMMEDIATE STOCK

Information on how to obtain additional copies is contained in References.

RECORD OF DOCUMENT CHANGES

Instructions: DISCARD EXISTING SHEET MD INSERT THIS NEW RECORD OF DOCUMENT CHANGES.

This is an inventory of all changes made to this design manual. Each change is consecutively numbered, and each change page in the design manual includes the date of the change which issued it.

Change Number	Description of Change	Date of Change	Page Changed
1	Added new cover with revalidation date.	September 1986	Cover
	Added Record of Document Changes page.		-
	New Abstract.		iii
	Added to Foreword address for sending recommended changes and changed signature to RADM Jones.		v
	Added listing of DM-7 series.		vi
	Deleted Preface.		vii
	Deleted list of Design Manuals.		ix
	New Table of Contents.		vii-xiv
	New acknowledgments.		xv
	Deleted DM-9 and corrected title of DM 5.04 in Related Criteria.		7.1-1
	Changed date of Reference 13.		7.1-45
	Added NAVFAC DM's to Reference list.		7.1-47
	Updated Related Criteria listing.		7.1-49
	Added NAVFAC DM's and P-Pubs to Reference list.		7.1-116
	Updated Related Criteria listing.		7.1-117
	Changed AASHTO T174 to AASHTO T190.		7.1-126

RECORD OF DOCUMENT CHANGES (Continued)

Change Number	Description of Change	Date of Change	Page Changed
1	Changed DM-5 to DM-5.04 in paragraph 4.		7.1-154
	Added NAVFAC DM's to Reference list.		7.1-160
	Deleted NAVDOCKS P-81 and updated DM's in Related Criteria listing.		7.1-161
	Changed P/ to P/[pi].		7.1-175
	Added NAVFAC DM's to Reference list.		7.1-204
	Deleted DM-5.11 and updated DM's in Related Criteria list.		7.1-159
	Restated equations for Z+r, of q for the case of circle of wells penetrating artesian stratum.		7.1-284
	Added NAVFAC DM's and P-Pubs to Reference List.		7.1-307
	Changed Figure 15 to Figure 14.		7.1-346
	Added DD Form 1426.		
	Changed "plain" to "plane" in two places.		7.1-A-2

## **ABSTRACT**

This manual covers the application of engineering principles by experienced engineers of soil mechanics in the design of foundations and earth structures for naval shore facilities. The contents include identification and classification of soil and rock, field exploration, testing, and instrumentation, laboratory testing, distribution of stresses including pressures on buried structures, analysis of settlement and volume expansion, seepage and drainage, and slope stability and protection.



PAGE iv INTENTIONALLY BLANK

## FOREWORD

This design manual is one of a series developed from an evaluation of facilities in the shore establishment, from surveys of the availability of new materials and construction methods, and from selection of the best design practices of the Naval Facilities Engineering Command (NAVFACENGCOM), other Government agencies, and the private sector. This manual uses, to the maximum extent feasible, national professional society, association, and institute standards in accordance with NAVFACENGCOM policy. Deviations from these criteria should not be made without prior approval of NAVFACENGCOM Headquarters (Code 04).

Design cannot remain static any more than the rival functions it serves or the technologies it uses. Accordingly, recommendations for improvement are encouraged from within the Navy and from the private sector and should be furnished to Commander, Naval Facilities Engineering Command (Code 04B), 200 Stovall Street, Alexandria, VA 22332-2300.

This publication is certified as an official publication of the Naval Facilities Engineering Command and has been reviewed and approved in accordance with SECNAVINST 5600.16, Procedures Governing Review of the Department of the Navy (DN) Publications.

J. P. JONES, JR.  
Rear Admiral, CEC, U. S. Navy  
Commander  
Naval Facilities Engineering Command

SOILS AND FOUNDATIONS DESIGN MANUALS

DM	Title
)	))))
7.01	Soil Mechanics
7.02	Foundations and Earth Structures
7.03	Soil Dynamics, Peep Stabilization and Special Geotechnical Construction

CONTENTS

	Page
<b>CHAPTER 1. IDENTIFICATION ID CLASSIFICATION OF SOIL ID ROCK</b>	
Section 1. Introduction.....	7.1-1
Section 2. Soil Deposits.....	7.1-1
Section 3. Soil Identification.....	7.1-7
Section 4. Soil Classification and Properties.....	7.1-16
Section 5. Rock Classification and Properties.....	7.1-19
Section 6. Special Materials.....	7.1-34
<b>CHAPTER 2. FIELD EXPLORATION, TESTING, AND INSTRUMENTATION</b>	
Section 1. Introduction.....	7.1-49
Section 2. Published Soil and Geological Maps.....	7.1-51
Section 3. Remote Sensing Data Methods.....	7.1-51
Section 4. Geophysical Methods.....	7.1-59
Section 5. Soil Borings and Test Pit.....	7.1-65
Section 6. Sampling.....	7.1-73
Section 7. Penetration Resistance Tests.....	7.1-85
Section 8. Groundwater Measurements.....	7.1-93
Section 9. Measurement of Soil and Rock Properties In Situ.....	7.1-97
Section 10. Field Instrumentation.....	7.1-110
<b>CHAPTER 3. LABORATORY TESTING</b>	
Section 1. Introduction.....	7.1-117
Section 2. Index Properties Tests.....	7.1-134
Section 3. Permeability Tests.....	7.1-137
Section 4. Consolidation Tests.....	7.1-138
Section 5. Shear Strength Tests.....	7.1-145
Section 6. Dynamic Testing.....	7.1-151
Section 7. Tests on Compacted Soils.....	7.1-153
Section 8. Tests on Rock.....	7.1-154
<b>CHAPTER 4. DISTRIBUTION OF STRESSES</b>	
Section 1. Introduction.....	7.1-161
Section 2. Stress Conditions at a Point.....	7.1-161
Section 3. Stresses Beneath Structures and Embankments.....	7.1-162
Section 4. Shallow Pipes and Conduits.....	7.1-181
Section 5. Deep Underground Openings.....	7.1-192
Section 6. Numerical Stress Analysis.....	7.1-202

<b>CHAPTER 5. ANALYSIS OF SETTLEMENT AND VOLUME EXPANSION</b>	
Section 1.	Introduction.....7.1-205
Section 2.	Analysis of Stress Conditions.....7.1-205
Section 3.	Instantaneous Settlement.....7.1-209
Section 4.	Primary and Secondary Settlements.....7.1-223
Section 5.	Tolerable and Differential Settlement.....7.1-238
Section 6.	Methods of Reducing or Accelerating Settlement.....7.1-241
Section 7.	Analysis of Volume Expansion.....7.1-253
<b>CHAPTER 6. SEEPAGE AND DRAINAGE</b>	
Section 1.	Introduction.....7.1-259
Section 2.	Seepage Analysis.....7.1-259
Section 3.	Seepage Control by Cutoff.....7.1-263
Section 4.	Design of Drainage Blanket and Filters.....7.1-271
Section 5.	Wellpoint Systems and Deep Wells.....7.1-279
Section 6.	Linings for Reservoirs and Pollution Control Facilities.....7.1-286
Section 7.	Erosion Control.....7.1-286
<b>CHAPTER 7. SLOPE STABILITY AND PROTECTION</b>	
Section 1.	Introduction.....7.1-309
Section 2.	Types of Failures.....7.1-309
Section 3.	Methods of Analysis.....7.1-314
Section 4.	Effects of Soil Parameters and Groundwater on Stability.....7.1-331
Section 5.	Slope Stabilization.....7.1-335
Section 6.	Slope Protection.....7.1-338
<b>BIBLIOGRAPHY.....7.1-B-1</b>	
<b>APPENDIX A - Listing of Computer Programs</b>	
<b>GLOSSARY.....7.1-G-1</b>	
<b>SYMBOLS.....7.1-S-1</b>	
<b>INDEX.....7.1-INDEX-1</b>	

FIGURES

Figure	Title	Page
CHAPTER 1		
1	Estimated Compactness of Sand from Standard Penetration Test....	7.1-14
2	Utilization of Atterberg Plasticity Limits.....	7.1-18
3	Strength Classification.....	7.1-33
4	Volume Change Potential Classification for Clay Soils.....	7.1-38
5	Criterion for Collapse Potential: U.S.B.R.....	7.1-40
6	Typical Collapse Potential Test Results.....	7.1-41
7	Extreme Frost Penetration (in inches) Based Upon State Average..	7.1-42
CHAPTER 2		
1	Sample Boring Log.....	7.1-50
2	Standard Sizes, in Inches, for Casings, Rods, Core Barrels, and Roles.....	7.1-81
3	Correlations Between Relative Density and Standard Penetration Resistance in Accordance with Gibbs and Holtz.....	7.1-87
4	Correlations of Standard Penetration Resistance.....	7.1-88
5	Shear Modulus vs. N Values (SPT) at Very Small Strains.....	7.1-89
6	Dutch Cone Penetrometer.....	7.1-92
7	Open Standpipe Piezometers.....	7.1-95
8	Porous Element Piezometers.....	7.1-96
9	Sources of Error and Corrective Methods in Groundwater Pressure Measurements.....	7.1-98
10	Vane Shear Test Arrangement.....	7.1-99
11	Menard Pressuremeter Equipment.....	7.1-101
12	Analysis of Plate Bearing Tests.....	7.1-102
13	Analysis of Permeability by Variable Head Tests .....	7.1-104
14	Test Zone Isolation Methods.....	7.1-107
15	Example of Instrumentation Adjacent to a Building and Diaphragm Wall.....	7.1-111
CHAPTER 3		
1	Permeability of Sands and Sand-Gravel Mixtures.....	7.1-139
2	Consolidation Test Relationships.....	7.1-140
3	Preconsolidation Pressure vs. Liquidity Index.....	7.1-142
4	Approximate Correlations for Consolidation Characteristics of Silts and Clays.....	7.1-144
5	Triaxial Apparatus Schematic.....	7.1-146
6	Triaxial Shear Test Relationships.....	7.1-147
7	Correlations of Strength Characteristics for Granular Soils.....	7.1-149

Figure	Title	Page
CHAPTER 4		
1	Examples of Stress Conditions at a Point.....	7.1-164
2	Formulas for Stresses in Semi-Infinite Elastic Foundation.....	7.1-165
3	Stress Contours and Their Application.....	7.1-167
4	Influence Value for Vertical Stress Beneath a Corner of a Uniformly Loaded Rectangular Area (Boussinesq Case).....	7.1-168
5	Influence Value for Vertical Stress Under Uniformly Loaded Circular Area (Boussinesq Case).....	7.1-169
6	Influence Value for Vertical Stress Under Embankment Load of Infinite Length (Boussinesq Case).....	7.1-170
7	Influence Value for Vertical Stress Beneath Triangular Load (Boussinesq Case).....	7.1-171
8	Examples of Computation of Vertical Stress.....	7.1-172
9	Determination of Stress Below Corner of Uniformly Loaded Rectangular Area.....	7.1-173
10	Influence Chart for Vertical Stress Beneath Irregular Load.....	7.1-174
11	Vertical Stress Contours for Square and Strip Footings (Westergaard Case).....	7.1-176
12	Influence Value for Vertical Stress Beneath a Corner of a Uniformly Loaded Rectangular Area (Westergaard Case).....	7.1-177
13	Influence Value for Vertical Stress Beneath Triangular Load (Westergaard Case).....	7.1-178
14	Influence Values for Vertical Stresses Beneath Uniformly Loaded Circular Area (Two-layer Foundation).....	7.1-179
15	Stress Profile in a Two-Layer Soil Mass.....	7.1-180
16	Contact Pressure Under (a) Rigid Footings (b) Flexible Foundation on an Elastic Half Space.....	7.1-182
17	Influence Values for Vertical Stresses Around a Pile in an Elastic Solid.....	7.1-183
18	Backfill Coefficients, Embankment Loads, and Load Factors for Rigid Conduits.....	7.1-185
19	Vertical Pressure on Culvert Versus Height of Cover.....	7.1-187
20	Pressure Transfer Coefficients for Corrugated Flexible Conduits as a Function of Standard Soil Density and Ring Flexibility or Diameter and Corrugation Depth.....	7.1-189
21	Example of Ring Deflection.....	7.1-191
22	Conduits Beneath Embankments of Finite Width.....	7.1-193
23	Load Action on Underground Openings in Earth.....	7.1-197
24	Coefficients for Active or Passive Pressures on Underground Cylindrical Shafts or Silos.....	7.1-201
CHAPTER 5		
1	Consolidation Settlement Analysis.....	7.1-206
2	Profiles of Vertical Stresses Before Construction.....	7.1-207
3	Computation of Total Settlement for Various Loading Conditions..	7.1-210
4a	Relationship Between Settlement Ratio and Applied Stress Ratio for Strip Foundation on Homogeneous Isotropic Layer.....	7.1-216
4b	Relationship Between Initial Shear Stress and Overconsolidation Ratio.....	7.1-217

Figure	Title	Page
CHAPTER 5 (continued)		
5	Example of Immediate Settlement Computations in Clay.....	7.1-218
6	Instantaneous Settlement of Isolated Footings on Coarse-Grained Soils.....	7.1-219
7	Settlement of Footings Over Granular Soils: Example Computation Using Schmertmann's Method.....	7.1-220
8	Relation Between Settlement Ratio and Overconsolidation Ratio...	7.1-225
9	Time Rate of Consolidation for Vertical Drainage Due to Instantaneous Loading.....	7.1-227
10	Vertical Sand Drains and Settlement Time Rate.....	7.1-228
11	Nomograph for Consolidation With Vertical Drainage.....	7.1-229
12	Effect of Drainage Conditions on Time Rate of Consolidation....	7.1-230
13	Time Rate of Consolidation for Gradual Load Application.....	7.1-232
14	Coefficient of Consolidation from Field Measurements.....	7.1-233
15	Procedure for Determining the Rate of Consolidation for All Soil Systems Containing "N" Layers.....	7.1-235
16	Coefficient of Secondary Compression as Related to Natural Water Content.....	7.1-237
17	Surcharge Load Required to Eliminate Settlement Under Final Load.....	7.1-245
18	Data for Typical Sand Drain Installation.....	7.1-248
19	Nomograph for Consolidation with Radial Drainage to Vertical Sand Drain.....	7.1-249
20	Example of Surcharge and Sand Drain Design.....	7.1-250
21	Allowance for Smear Effect in Sand Drain Design.....	7.1-252
22	Computation of Swell of Desiccated Clays.....	7.1-256
CHAPTER 6		
1	Flow Net Construction and Seepage Analysis.....	7.1-260
2	Penetration of Cut Off Wall to Prevent Piping in Isotropic Sand.....	7.1-268
3	Penetration of Cut Off Wall Required to Prevent Piping in Stratified Sand.....	7.1-269
4	Design Criteria for Protective Filters.....	7.1-272
5	Typical Filter and Drainage Blanket Applications.....	7.1-276
6	Permeability and Capillarity of Drainage Materials.....	7.1-277
7	Analysis of Drainage Layer Performance.....	7.1-278
8	Intercepting Drains for Roadways on a Slope.....	7.1-280
9	Rate of Seepage into Drainage Trench.....	7.1-281
10	Groundwater Lowering by Pumping Wells.....	7.1-284
11	Drainage of Artesian Layer by Line of Relief Wells.....	7.1-285
12	Nomograph for Determining Soil Erodibility (K) for Universal Soil Loss Equation.....	7.1-290
13	Capacity of Sediment Control Ponds.....	7.1-302
14	Design Criteria for Riprap and Filter on Earth Embankments.....	7.1-304



Figure	Title	Page
CHAPTER 7		
1	Method of Slices - Simplified Bishop Method (Circular Slip Surface).....	7.1-315
2	Stability Analysis for Slopes in Cohesive Soils, Undrained Conditions, i.e., Assumed $[\phi] = 0$ .....	7.1-319
3	Center of Critical Circle, Slope in Cohesive Soil.....	7.1-320
4	Influence of Surcharge, Submergence, and Tension Cracks on Stability.....	7.1-321
5	Design of Berms for Embankments on Soft Clays.....	7.1-322
6	Stability Analysis of Translational Failure.....	7.1-323
7	Example of Stability Analysis of Translational Failure.....	7.1-325
8	Stability of Rock Slope.....	7.1-328
9	Earthquake Loading on Slopes.....	7.1-330
10	Correction Factors R+E, and R+F, to Account for Progressive Failure in Embankments on Soft Clay Foundations.....	7.1-332
11	Influence of Stabilizing Pile on Safety Factor.....	7.1-339
12	Pile Stabilized Slope.....	7.1-341
13	Example Calculation - Pile Stabilized Slopes.....	7.1-342

TABLES

Table	Title	Page
CHAPTER 1		
1	Principal Soil Deposits.....	7.1-2
2	Visual Identification of Samples.....	7.1-8
3	Unified Soil Classification System.....	7.1-9
4	Guide for Consistency of Fine-Grained Soils.....	7.1-17
5	Soil Classification for Organic Soils.....	7-1-20
6	Typical Values of Soil Index Properties.....	7.1-22
7	Weathering Classification.....	7.1-24
8	Discontinuity Spacing.....	7.1-25
9	Hardness Classification of Intact Rock.....	7.1-27
10	Simplified Rock Classification.....	7.1-28
11	Engineering Classification for In Situ Rock Quality.....	7.1-32
12	Identification and Characteristics of Special Materials.....	7.1-35
CHAPTER 2		
1	Sources of Geological Information.....	7.1-52
2	Remote Sensing Data.....	7.1-55
3	Onshore Geophysics for Engineering Purposes.....	7.1-60
4	Offshore Geophysical Methods.....	7.1-63
5	Types of Test Borings.....	7.1-66
6	Requirements for Boring Layout.....	7.1-68
7	Requirements for Boring Depths.....	7.1-70
8	Use, Capabilities and Limitations of Test Pits and Trenches.....	7.1-72
9	Common Samplers for Disturbed Soil Samples and Rock Cores.....	7.1-74
10	Common Samplers for Undisturbed Samples.....	7.1-77
11	Sampling of Disintegrated Rock Zones.....	7.1-82
12	Common Underwater Samplers.....	7.1-83
13	Procedures Which May Affect the Measured N Values.....	7.1-90
14	Groundwater or Piezometric Level Monitoring Devices.....	7.1-94
15	Shape Factors for Computation of Permeability From Variable Head Tests.....	7.1-105
16	Load and Temperature Devices in Walled Excavation Elements.....	7.1-113
CHAPTER 3		
1	Requirements for Index Properties Tests and Testing Standards...	7.1-118
2	Requirements for Structural Properties.....	7.1-121
3	Requirements for Dynamic Tests.....	7.1-124
4	Requirements for Compacted Samples Tests.....	7.1-125
5	Soil Properties for Analysis and Design.....	7.1-127
6	Volume and Weight Relationships.....	7.1-135
7	Capabilities of Dynamic Testing Apparatus.....	7.1-152
8	Test Procedures for Intact Rock.....	7.1-155
9	Test Procedures for Aggregate.....	7.1-157

Table	Title	Page
CHAPTER 4		
1	Overburden Rock Load Carried by Roof Support.....	7.1-195
2	Loads for Temporary Supports in Earth Tunnels at Depths More Than 1.5 (B + H+t,).....	7.1-199
CHAPTER 5		
1	Shape and Rigidity Factors I for Calculating Settlements of Points on Loaded Areas at the Surface of an Elastic Half-Space.....	7.1-212
2	Relationship Between Undrained Modulus and Overconsolidation Ratio.....	7.1-215
3	Estimates of Coefficient of Consolidation (C+c,).....	7.1-224
4	Tolerable Settlements for Building.....	7.1-239
5	Tolerable Differential Settlement for Miscellaneous Structures..	7.1-240
6	Methods of Reducing or Accelerating Settlement or Coping with Settlement.....	7.1-242
7	Common Types of Vertical Drains.....	7.1-247
8	Heave From Volume Change.....	7.1-254
CHAPTER 6		
1	Cutoff Methods for Seepage Control.....	7.1-264
2	Impermeable Reservoir Linings.....	7.1-287
3	Typical Erosion Control Practice.....	7.1-291
4	Limiting Flow Velocities to Minimize Erosion.....	7.1-300
CHAPTER 7		
1	Analysis of Stability of Natural Slopes.....	7.1-310
2	Analysis of Stability of Cut and Fill Slopes, Conditions Varying with Time.....	7.1-312
3	Pore Pressure Conditions for Stability Analysis of Homogeneous Embankment.....	7.1-334
4	Methods of Stabilizing Excavation Slopes.....	7.1-336
5	Thickness and Gradation Limits of Dumped Riprap.....	7.1-347

## ACKNOWLEDGMENTS

Figure or Table	Acknowledgments
Table 4, Chapter 1	Terzaghi, K., and Peck, R.B., Soil Mechanics in Engineering Practice, John Wiley & Sons, New York, 1967.
Figure 3, Chapter 1	Broch, E., and Franklin, J.A., The Point Load Strength Test, International Journal of Rock Mechanics and Mineral Sciences, Pergamon Press, 1972.
Table 6, Chapter 1	Hough, B.K., Basic Soils Engineering, Ronald Press, New York, 1969.
Figure 10, Chapter 2	Acker Soil Sampling Catalog, Acker Drill Company, Scranton, PA.
Figure 14, Chapter 4	Mehta, M.R., and Veletsos, A.S., Stresses and Displacement in Layered Systems, Structural Research Series No. 178, University of Illinois, Urbana, IL.
Figures 18(a), 20, and 21, Chapter 4	Watkins, R.K., Buried Structures, Foundation Engineering Handbook, Winterkorn, H.F. and Fang, H.Y., ed., Chapter 27, Van Nostrand Reinhold Company, New York, 1975.
Figure 18(c), Chapter 4	Soft Ground Tunneling, (Company Brochure T-1), Commercial Shearing, Inc., Youngstown, OH., 1971.
Figure 18(e), Chapter 4	Concrete Pipe Design Manual, American Concrete Pipe Association, Vienna, VA., 1980.
Table 1, Chapter 4	Proctor, R.V., and White, T.L., Rock Tunneling with Steel Supports, Commercial Shearing, Inc., Youngstown, OH., 1977.
Figure 23 and Table 2, Chapter 4	Proctor, R.V., and White, T.L., Earth Tunneling with Steel Supports, Commercial Shearing, Inc., Youngstown, OH., 1977.
Figure 1, Chapter 7	Lambe, T.W., and Whitman, R.V., Soil Mechanics, John Wiley & Sons, Inc., New York, 1969.
Figures 2 and 3, Chapter 7	Janbu, N., Stability Analysis of Slopes with Dimensionless Parameters, Harvard Soil Mechanics Series No. 46, Harvard University, Cambridge, MA.

CHAPTER 1. IDENTIFICATION AND CLASSIFICATION OF SOIL AND ROCK

Section 1. INTRODUCTION

1. SCOPE. This chapter presents criteria for soil and rock identification and classification plus information on their physical engineering properties. Common soils and rock are discussed as well as special materials such as submarine soils and coral, saprolitic soils, lateritic soils, expansive and collapsing soils, cavernous limestone, quick clay, permafrost and hydraulically placed fills.

2. RELATED CRITERIA. For additional criteria on the classification and identification of soil and rock, see the following sources:

Subject	Source
Pavements.....	NAVFAC DM-5.04
Airfield Pavement.....	NAVFAC DM-21 Series

Section 2. SOIL DEPOSITS

1. GEOLOGIC ORIGIN AND MODE OF OCCURRENCE.

a. Principal Soil Deposits. See Table 1 for principal soil deposits grouped in terms of origin (e.g., residual, colluvial, etc.) and mode of occurrence (e.g., fluvial, lacustrine, etc.).

b. Importance. A geologic description assists in correlating experiences between several sites, and in a general sense, indicates the pattern of strata to be expected prior to making a field investigation (test borings, etc.). Soils with similar origin and mode of occurrence are expected to have comparable if not similar engineering properties. For quantitative foundation analysis, a geological description is inadequate and more specific classification is required. For sources of information on the physical geology of the United States, see Chapter 2. A study of references on local geology should precede a major subsurface exploration program.

c. Soil Horizon. Soil horizons are present in all sedimentary soils and transported soils subject to weathering. The A horizon contains the maximum amount of organic matter; the underlying B horizon contains clays, sesquioxides, and small amounts of organic matter. The C horizon is partly weathered parent soil or rock and the D horizon is unaltered parent soil and rock.

TABLE 1  
Principal Soil Deposits

Major Division	Principal Soil Deposits	Pertinent Engineering Characteristics
SEDIMENTARY SOILS - Residual		
Material formed by disintegration of underlying parent rock or partially indurated material.	<u>Residual sands</u> and fragments of gravel size formed by solution and leaching of cementing material, leaving the more resistant particles; commonly quartz  <u>Residual clays</u> formed by decomposition of silicate rocks, disintegration of shales, and solution of carbonates in limestone. With few exceptions becomes more compact, rockier, and less weathered with increasing depth. At intermediate stage may reflect composition, structure, and stratification of parent rock.	Generally favorable foundation conditions  Variable properties requiring detailed investigation. Deposits present favorable foundation conditions except in humid and tropical climates, where depth and rate of weathering are very great.
Organic		
Accumulation of highly organic material formed in place by the growth and subsequent decay of plant life.	<u>Peat</u> . A somewhat fibrous aggregate of decayed and decaying vegetation matter having a dark color and odor of decay.  <u>Muck</u> . Peat deposits which have advanced in stage of decomposition to such extent that the botanical character is no longer evident.	Very compressible. Entirely unsuitable for supporting building foundations,

TABLE 1 (continued)  
Principal Soil Deposits

Major Division	Principal Soil Deposits	Pertinent Engineering Characteristics
TRANSPORTED SOILS -		
Alluvial		
Material transported and deposited by running water.	<p><u>Floodplain deposits.</u> Deposits laid down by a stream within that portion of its valley subject to inundation by floodwaters.</p>	
	<p><u>Point bar.</u> Alternating deposits of arcuate ridges and swales (lows) formed on the inside or convex bank of mitigating river bends. Ridge deposits consist primarily of silt and sand, swales are clay-filled.</p>	<p>Generally favorable foundation conditions; however, detailed investigations are necessary to locate discontinuities. Flow slides may be a problem along riverbanks. Soils are quite pervious.</p>
	<p><u>Channel fill.</u> Deposits laid down in abandoned meander loops isolated when rivers shorten their courses. Composed primarily of clay; however, silty and sandy soils are found at the upstream and downstream ends.</p>	<p>Fine-grained soils are usually compressible. Portions may be very heterogeneous. Silty soils generally present favorable foundation conditions.</p>
	<p><u>Backswamp.</u> The prolonged accumulation of floodwater sediments in flood basins bordering a river. Materials are generally clays but tend to become more silty near riverbank.</p>	<p>Relatively uniform in a horizontal direction. Clays are usually subjected to seasonal volume changes.</p>
	<p><u>Alluvial Terrace deposits.</u> Relatively narrow, flat-surfaced, river-flanking remnants of floodplain deposits formed by entrenchment of rivers and associated processes.</p>	<p>Usually drained, oxidized. Generally favorable foundation conditions.</p>

TABLE 1 (continued)  
Principal Soil Deposits

Major Division	Principal Soil Deposits	Pertinent Engineering Characteristics
* (cont'd) * Materials transported and deposited by running water.	* <u>Estuarine deposits</u> . Mixed deposits of marine and alluvial origin laid down in widened channels at mouths of rivers and influenced by tide of body of water into which they are deposited.	* Generally fine-grained and compressible. Many local variations in soil conditions.
* * * * *	* <u>Alluvial-Lacustrine deposits</u> . Material deposited within lakes (other than those associated with glaciation) by waves, currents, and organo-chemical processes. Deposits consist of unstratified organic clay or clay in central portions of the lake and typically grade to stratified silts and sands in peripheral zones.	* Usually very uniform in horizontal direction. Fine-grained soils generally compressible.
* * * * *	* <u>Deltaic deposits</u> . Deposits formed at the mouths of rivers which result in extension of the shoreline.	* Generally fine-grained and compressible. Many local variations in soil condition.
* * * * *	* <u>Piedmont deposits</u> . Alluvial deposits at foot of hills or mountains. Extensive plains or alluvial fans.	* Generally favorable foundation conditions.
* Aeolian * * * * *	* * * * *	* * * * *
* Material transported and deposited by wind.	* <u>Loess</u> . A calcareous, unstratified deposit of silts or sandy or clayey silt traversed by a network of tubes formed by root fibers now decayed.	* Relatively uniform deposits characterized by ability to stand in vertical cuts. Collapsible structure. Deep weathering or saturation can modify characteristics.
* * * * *	* <u>Dune sands</u> . Mounds, ridges, and hills of uniform fine sand characteristically exhibiting rounded grains.	* Very uniform grain size; may exist in relatively loose condition.



TABLE 1 (continued)  
Principal Soil Deposits

Major Division	Principal Soil Deposits	Pertinent Engineering Characteristics
*Glacial *Material transported and deposited by glaciers, or by meltwater from the glacier.	* <u>Glacial till</u> . An accumulation of debris, deposited beneath, at the side (lateral moraines), or at the lower limit of a glacier (terminal moraine). Material lowered to ground surface in an irregular sheet by a melting glacier is known as a ground moraine.	* Consists of material of all sizes in various proportions from boulder and gravel to clay. Deposits are unstratified. Generally present favorable foundation conditions; but, rapid changes in conditions are common.
*Marine *Material transported and deposited by ocean waves and currents in shore and offshore areas.	* <u>Glacio-Fluvial deposits</u> . Coarse and fine-grained material deposited by streams of meltwater from glaciers. Material deposited on ground surface beyond terminal of glacier is known as an outwash plain. Gravel ridges known as kames and eskers.  * <u>Glacio-Lacustrine deposits</u> . Material deposited within lakes by meltwater from glaciers. Consisting of clay in central portions of lake and alternate layers of silty clay or silt and clay (varved clay) in peripheral zones.	* Many local variations. Generally present favorable foundation conditions.  * Very uniform in a horizontal direction.
*Material transported and deposited by ocean waves and currents in shore and offshore areas.	* <u>Shore deposits</u> . Deposits of sands and/or gravels formed by the transporting, destructive, and sorting action of waves on the shoreline.  * <u>Marine clays</u> . Organic and inorganic deposits of fine-grained material.	* Relatively uniform and of moderate to high density.  * Generally very uniform in composition. Compressible and usually very sensitive to remolding.

TABLE 1 (continued)  
Principal Soil Deposits

Major Division	Principal Soil Deposits	Pertinent Engineering Characteristics
*Colluvial	* <u>Talus</u> . Deposits created by gradual accumulation of unsorted rock fragments and debris at base of cliffs.	* Previous movement indicates possible future difficulties. Generally unstable foundation conditions.
*Material transported and deposited by gravity.	* <u>Hillwash</u> . Fine colluvium consisting of clayey sand, sand silt, or clay.	
*Pyroclastic	* <u>Landslide deposits</u> . Considerable masses of soil or rock that have slipped down, more or less as units, from their former position on steep slopes.	
*Material ejected from volcanoes and transported by gravity, wind and air.	* <u>Ejecta</u> . Loose deposits of volcanic ash, lapilli, bombs, etc.	* Typically shardlike particles of silt size with larger volcanic debris. Weathering and redeposition produce highly plastic, compressible clay. Unusual and difficult foundation conditions.
	* <u>Pumice</u> . Frequently associated with lava flows and mud flows, or may be mixed with nonvolcanic sediments.	

### Section 3. SOIL IDENTIFICATION

1. REQUIREMENTS. A complete engineering soil identification includes: (a) a classification of constituents, (b) the description of appearance and structural characteristics, and (c) the determination of compactness or consistency in situ.

a. Field Identification. Identify constituent materials visually according to their grain size, and/or type of plasticity characteristics per ASTM Standard D2488, Description of Soils (Visual-Manual Procedure).

(1) Coarse-Grained Soils. Coarse-grained soils are those soils where more than half of particles finer than 3-inch size can be distinguished by the naked eye. The smallest particle that is large enough to be visible corresponds approximately to the size of the opening of No. 200 sieve used for laboratory identification. Complete identification includes grain size, color, and/or estimate of compactness.

(a) Color. Use color that best describes the sample. If there are two colors describe both colors. If there are more than two distinct colors, use multi-colored notation.

(b) Grain Size. Identify components and fractions in accordance with Table 2 - Coarse-Grained Soils.

(c) Grading. Identify both well graded or poorly graded sizes as explained in Table 3, under Supplementary Criteria for Visual Identification.

(d) Assigned Group Symbol. Use Table 3 for estimate of group symbols based on the Unified Classification System.

(e) Compactness. Estimate compactness in situ by measuring resistance to penetration of a selected penetrometer or sampling device (see Chapter 2). If the standard penetration test is performed, determine the number of blows of a 140 pound hammer falling 30 inches required to drive a 2-inch OD, 1-3/8 inch ID split barrel sampler 1 foot. The number of blows thus obtained is known as the standard penetration resistance, N. The split barrel is usually driven 18 inches. The penetration resistance is based on the last 12 inches.

1) Description Terms. See Figure 1 (Reference 1, Soils and Geology, Procedures for Foundation Design of Buildings and Other Structures (Except Hydraulic Structures), by the Departments of the Army and Air Force) for descriptive terms of compactness of sand. Figure 1 is applicable for normally consolidated sand.

2) Compactness Based on Static Cone Penetration Resistance,  $q+c$ ,. Reference 2, Cone Resistance as Measure of Sand Strength, by Mitchell and Lunne, provides guidance for estimating relative density with respect to the cone resistance. If  $q+c$ , and N values are measured during the field exploration, a  $q+c$ , -N correlation could be made, and Figure 1 is used to describe compactness. If N is not measured, but  $q+c$ , is measured, then use

TABLE 2  
Visual Identification of Samples

+)))))))))))))			
*Definitions of Soil Components and Fractions			
*			
*1. Grain Size			
*			
	Material	Fraction	Sieve Size
	))))))	))))))	))))))
	Boulders		12"+
	Cobbles		3" - 12"
	Gravel	coarse	3/4" - 3"
		fine	No. 4 to 3/4"
	Sand	coarse	No. 10 to No. 4
		medium	No. 40 to No. 10
		fine	No. 200 to No. 40
	Fines		Passing No. 200
	(Silt & Clay)		
*2. Coarse- and Fine-Grained Soils			
*			
	Descriptive Adjective	Percentage Requirement	
	))))))	))))))	
	trace	1	- 10%
	little	10	- 20%
	some	20	- 35%
	and	35	- 50%
*3. Fine-Grained Soils. Identify in accordance with plasticity characteristics, dry strength, and toughness as described in Table 3.			
*			
	Descriptive Term	Thickness	
	))))))	))))))	
	* alternating		
	* thick		
	* thin		
	* with		
	* parting	- 0 to 1/16" thickness	
	* seam	- 1/16 to 1/2" thickness	
	* layer	- 1/2 to 12" thickness	
	* stratum	- greater than 12" thickness	
	* varved Clay	- alternating seams or layers of sand, silt and clay	
	* pocket	- small, erratic deposit, usually less than 1 foot	
	* lens	- lenticular deposit	
	* occasional	- one or less per foot of thickness	
	* frequent	- more than one per foot of thickness	
.)))))))))))))			

TABLE 3  
Unified Soil Classification System

Primary Divisions for Field and Laboratory Identification		Group Symbol	Typical Names	Laboratory Classification Criteria	Supplementary Criteria For Visual Identification
Coarse-grained soils. (More than half of material finer than 3-inch sieve is larger than No. 200 sieve size.)	Gravel. (More than half of the coarse fraction is larger than No. 4 sieve size about 1/4 inch.)	GW	Well graded gravels, gravel-sand mixtures, little or no fines.*	$C_u = \frac{D_{60}}{D_{10}}$ greater than 4.  $C_z = \frac{(D_{30})^2}{D_{10} \times D_{60}}$ between 1 and 3.	Wide range in grain size and substantial amounts of all intermediate particle size.
	Clean gravels. (Less than 5% of material smaller than No. 200 sieve size.)				
No. 200 sieve size.)		GP	Poorly graded gravels, gravel-sand mixtures, little or no fines.*	Not meeting both criteria for GW.	Predominantly one size (uniformly graded) or a range of sizes with some intermediate sizes missing (gap graded).

\* Materials with 5 to 12 percent smaller than No. 200 sieve are borderline cases, designated: GM-GM, SM-SC, etc.

TABLE 3 (continued)  
Unified Soil Classification System

Primary Divisions for Field and Laboratory Identification		Group Symbol	Typical Names	Laboratory Classification Criteria		Supplementary Criteria For Visual Identification
.....do.....	.....do.....	GM	Silty gravels, and gravel-sand-silt mixtures.	Atterberg limits "A" below "A" line, or PI less than 4.	Atterberg limits "A" above "A" line with PI between 4 & 7 is borderline case GM-GC	Nonplastic fines or fines of low plasticity.
	Gravels with fines. (More than 12% of material smaller than No. 200 sieve size.)*					
.....do.....	Sands. (More than half of the coarse fraction is smaller than No. 4 sieve size.)	SW	Well graded sands, gravelly sands, little or no fines.*	Atterberg limits "A" line, and PI greater than 7.	Wide range in grain sizes and substantial amounts of all intermediate particle sizes.	Plastic fines.
	Clean sands. (Less than 5% of material smaller than No. 200 sieve size.)					
		SP	Poorly graded sands and gravelly sands, little or no fines.*	$C_u = \frac{D_{60}}{D_{10}}$ greater than 6. $C_z = \frac{(D_{30})^2}{D_{10} \times D_{60}}$ between 1 and 3.	Predominately one size (uniformly graded) or a range of sizes with some intermediate sizes missing (gap graded).	

\* Materials with 5 to 12 percent smaller than No. 200 sieve are borderline cases, designated: GM-GM, SW-SC, etc.

TABLE 3 (continued)  
Unified Soil Classification System

Primary Divisions for Field and Laboratory Identification	Group Symbol	Typical Names	Laboratory Classification Criteria	Supplementary Criteria For Visual Identification
.....do.....	SM	Silty sands, sand-silt mixtures.	Atterberg limits below "A" line, or PI less than 4.	Nonplastic fines or fines of low plasticity.
.....do.....			Atterberg limits above "A" line with PI between 4 and 7 is borderline case SM-SC.	
Sands with fines. (More than 12% of material smaller than No. 200 sieve size.)*	SC	Clayey sands, sand-clay mixtures.	Atterberg limits above "A" line with PI greater than 7.	Plastic fines.

\* Materials with 5 to 12 percent smaller than No. 200 sieve are borderline cases, designated: CM-CM, SM-SC, etc.

TABLE 3 (continued)  
Unified Soil Classification System

Primary Divisions for Field and Laboratory Identification	Group Symbol	Typical Names	Laboratory Classification Criteria		Supplementary Criteria For Visual Identification		
			Atterberg limits below "A" line, or PI less than 4.	Atterberg limits above "A" line case ML-CL.	Dry Strength	Reaction to Shaking	Toughness Near Plastic Limit
Fine-grained soils. (More than half of material is smaller than No. 200 sieve size.) (Visual: more than half of particles are so fine that they cannot be seen by naked eye.)	ML	Inorganic silts, very fine sands, rock flour, silty or clayey fine sands.	Atterberg limits below "A" line, or PI less than 4.	Atterberg limits above "A" line case ML-CL.	None to slight	Quick to slow	None
	CL	Inorganic clays of low to medium plasticity; gravelly clays, silty clays, sandy clays, lean clays.	Atterberg limits above "A" line, with PI greater than 7.	Atterberg line case ML-CL.	Medium to high	None to very slow	Medium
	OL	Organic silts and organic silt-clays of low plasticity.	Atterberg limits below "A" line.		Slight to medium	Slow	Slight



TABLE 3 (continued)  
Unified Soil Classification System

Primary Divisions for Field and Laboratory Identification	Group Symbol	Typical Names	Laboratory Classification Criteria	Supplementary Criteria For Visual Identification		
				Dry Strength	Reaction to Shaking	Toughness Near Plastic Limit
.....do.....	MH	Inorganic silts, micaceous or diatomaceous fine sands or silts, elastic silts.	Atterberg limits below "A" line.	Slight to medium	Slow to none	Slight to medium
				High to very high	None	High
				Medium to high	None to very slow	Slight to medium
.....do.....	OH	Organic clays of medium to high plasticity.	Atterberg limits above "A" line.	High to very high	None	High
				Medium to high	None to very slow	Slight to medium
				Organic clays of medium to high plasticity.	Atterberg limit below "A" line	High ignition loss, LL and PI decrease after drying.
.....do.....	Pt	Peat, muck and other highly organic soils.	High ignition loss, LL and PI decrease after drying.	Organic color and odor, spongy feel, frequently fibrous texture.	Organic color and odor, spongy feel, frequently fibrous texture.	Organic color and odor, spongy feel, frequently fibrous texture.

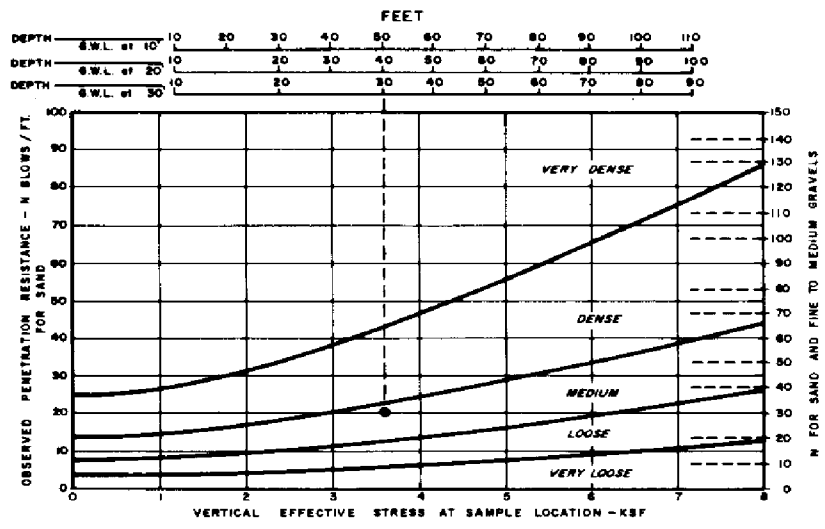

Example:

Blow count in sand at a depth of 40 ft = 20  
 Depth of Groundwater Table = 20 ft  
 Compactness ~ medium

FIGURE 1  
 Estimated Compactness of Sand from Standard Penetration Test

$N = q+c, /4$  for sand and fine to medium gravel and  $N = q+c, /5$  for sand, and use Figure 1 for describing compactness.

(f) Describe, if possible, appearance and structure such as angularity, cementation, coatings, and hardness of particles.

(g) Examples of Sample Description:

Medium dense, gray coarse to fine SAND, trace silt, trace fine gravel (SW). Dry, dense, light brown coarse to fine SAND, some silt (SM).

(2) Fine-Grained Soils. Soils are identified as fine-grained when more than half of the particles are finer than No. 200 sieve (as a field guide, such particles cannot be seen by the naked eye). Fine-grained soils cannot be visually divided between silt and clay, but are distinguishable by plasticity characteristics and other field tests.

(a) Field Identification. Identify by estimating characteristics in Table 3.

(b) Color. Use color that best describes the sample. If two colors are used, describe both colors. If there are more than two distinct colors, use multi-colored notation.

(c) Stratification. Use notations in Table 2.

(d) Appearance and Structure. These are best evaluated at the time of sampling. Frequently, however, it is not possible to give a detailed description of undisturbed samples in the field. Secondary structure in particular may not be recognized until an undisturbed sample has been examined and tested in the laboratory. On visual inspection, note the following items:

1) Ordinary appearance, such as color; moisture conditions, whether dry, moist, or saturated; and visible presence of organic material.

2) Arrangement of constituent materials, whether stratified, varved, or heterogeneous; and typical dip and thickness of lenses or varves.

3) Secondary structure, such as fractures, fissures, slickensides, large voids, cementation, or precipitates in fissures or openings.

(e) General Field Behavior.

1) Clays. Clays exhibit a high degree of dry strength in a small cube allowed to dry, high toughness in a thread rolled out at plastic limit, and exude little or no water from a small pat shaken in the hand.

2) Silts. Silts have a low degree of dry strength and toughness, and dilate rapidly on shaking so that water appears on the sample surface.

3) Organic Soils. Organic soils are characterized by dark colors, odor of decomposition, spongy or fibrous texture, and visible particles of vegetal matter.

(f) Consistency. Describe consistency in accordance with Table 4 (Reference 3, Soil Mechanics in Engineering Practice, by Terzaghi and Peck). Use a pocket penetrometer or other shear device to check the consistency in the field.

(g) Assignment of Group Symbol. Assign group symbol in accordance with Table 3.

(h) Examples of Sample Description:

Very stiff brown silty CLAY (CL), wet  
Stiff brown clayey SILT (ML), moist  
Soft dark brown organic CLAY (OH), wet.

#### Section 4. SOIL CLASSIFICATION AND PROPERTIES

1. REFERENCE. Soil designations in this manual conform to the Unified Soil Classification (see Table 3) per ASTM D2487, Classification of Soil for Engineering Purposes.

2. UTILIZATION. Classify soils in accordance with the Unified System and include appropriate group symbol in soil descriptions. (See Table 3 for elements of the Unified System.) A soil is placed in one of 15 categories or as a borderline material combining two of these categories. Laboratory tests may be required for positive identification. Use the system in Table 2 for field soil description and terminology.

a. Sands and Gravels. Sands are divided from gravels on the No. 4 sieve size, and gravels from cobbles on the 3-inch size. The division between fine and medium sands is at the No. 40 sieve, and between medium and coarse sand at the No. 10 sieve.

b. Silts and Clays. Fine-grained soils are classified according to plasticity characteristics determined in Atterberg limit tests. Categories are illustrated on the plasticity chart in Figure 2.

c. Organic Soils. Materials containing vegetable matter are characterized by relatively low specific gravity, high water content, high ignition loss, and high gas content. Decrease in liquid limit after oven-drying to a value less than three-quarters of the original liquid limit is a definite indication of an organic soil. The Unified Soil Classification categorizes organic soils based on the plotted position on the A-line chart as shown in Figure 2. However, this does not describe organic soils completely.

TABLE 4  
Guide for Consistency of Fine-Grained Soils

* SPT Penetration * (blows/foot)	* Estimated Consistency	* Estimated Range of * Unconfined * Compressive * Strength * tons/sq. ft.
<2	Very soft (extruded between fingers when squeezed)	<0.25
2 - 4	Soft (molded by light finger pressure)	0.25 - 0.50
4 - 8	Medium (molded by strong finger pressure)	0.50 - 1.00
8 - 15	Stiff (readily indented by thumb but penetrated with great effort)	1.00 - 2.00
15 - 30	Very stiff (readily indented by thumbnail)	2.00 - 4.00
>30	Hard (indented with difficulty by thumbnail)	>4.00

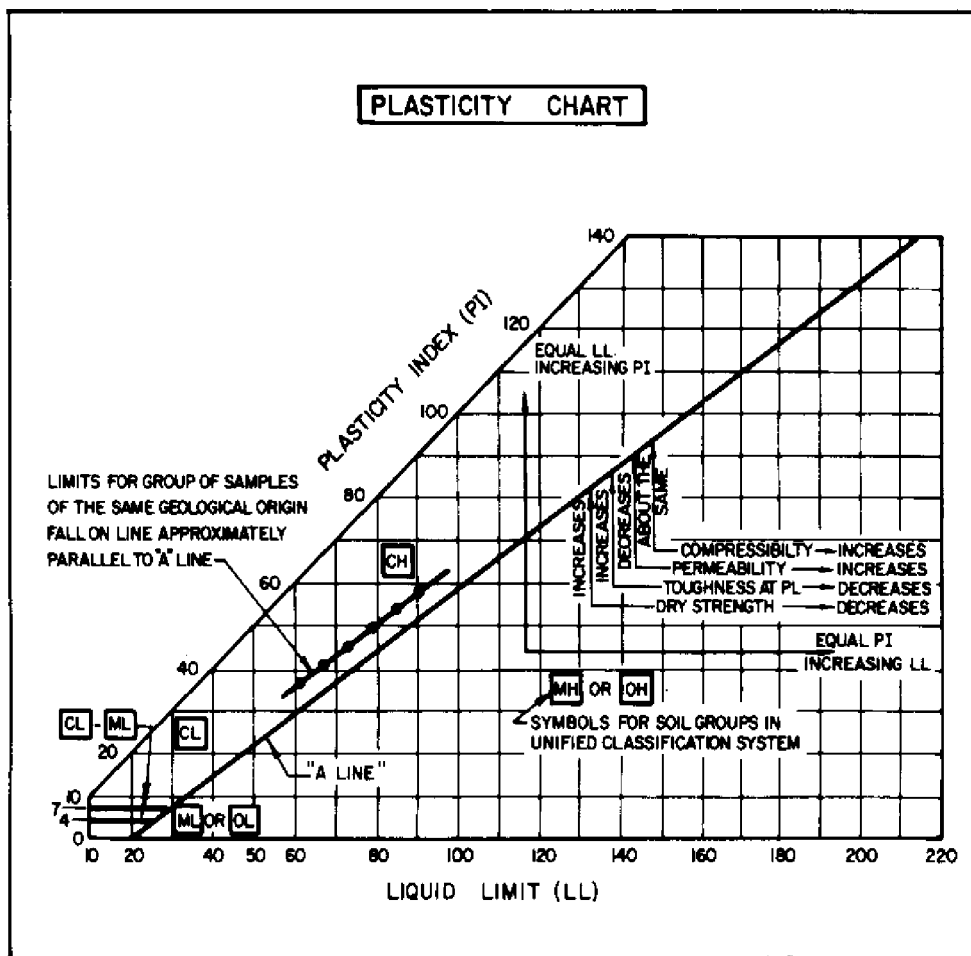

FIGURE 2  
Utilization of Atterberg Plasticity Limits

Therefore, Table 5 (Reference 4, unpublished work by Ayers and Plum) is provided for a more useful classification of organic soils.

For the characteristics of the Unified Soil Classification System pertinent to roads and airfields, see NAVFAC DM-5.4.

3. TYPICAL PROPERTIES. Some typical properties of soils classified by the Unified System are provided in Table 6 (Reference 5, Basic Soils Engineering, by Hough). More accurate estimates should be based on laboratory and/or field testing, and engineering evaluation.

#### Section 5. ROCK CLASSIFICATION AND PROPERTIES

1. VISUAL CLASSIFICATION. Describe the rock sample in the following sequence:

a. Weathering Classification. Describe as fresh, slightly weathered, etc. in accordance with Table 7 (Reference 6, Suggested Methods of the Description of Rock Masses, Joints and Discontinuities, by ISRM Working Party).

b. Discontinuity Classification. Describe spacing of discontinuities as close, wide, etc., in accordance with Table 8. In describing structural features, describe rock mass as thickly bedded or thinly bedded, in accordance with Table 8. Depending on project requirements, identify the form of joint (stepped, smooth, undulating, planar, etc.), its dip (in degrees), its surface (rough, smooth, slickensided), its opening (giving width), and its filling (none, sand, clay, breccia, etc.).

c. Color and Grain Size. Describe with respect to basic colors on rock color chart (Reference 7, Rock Color Chart, by Geological Society of America). Use the following term to describe grain size:

(1) For Igneous and Metamorphic Rocks:

coarse-grained - grain diameter >5mm

medium-grained - grain diameter 1 - 5mm

fine-grained - grain diameter <1mm

aphanitic - grain size is too small to be perceived by unaided eye

glassy - no grain form can be distinguished.

(2) For Sedimentary Rocks

coarse-grained - grain diameter >2mm

medium-grained - grain diameter = 0.06 - 2mm

TABLE 5  
Soil Classification for Organic Soils

Category	Name	Organic Content (% by wt.)	Group Symbols (See Table 3)	Distinguishing Characteristics For Visual Identification	Range of Laboratory Test Values
ORGANIC MATTER	FIBROUS PEAT (woody, mats, etc.)	75 to 100% Organics either visible or inferred	Pt	Light weight, spongy and often elastic at $w_p$ --- shrinks considerably on air drying. Much water squeezes from sample.	$w_p$ --500 to 1200% $\gamma$ --60 to 70 pcf G--1.2 to 1.8 $C_c/(1+e_0)$ = .4+
	FINE GRAINED PEAT (amorphous)	Organics either visible or inferred		Light weight, spongy but not often elastic at $w_p$ --- shrinks considerably on air drying. Much water squeezes from sample.	$w_p$ --400 to 800% LL--400 to 900% PI--200 to 500 $\gamma$ --60 to 70 pcf G--1.2 to 1.8 $C_c/(1+e_0)$ = .35 to .4+
HIGHLY ORGANIC SOILS	Silty Peat	30 to 75% Organics either visible or inferred	Pt	Relatively light weight, spongy. Thread usually weak and spongy near PL Shrinks on air drying; medium dry strength. Usually can squeeze water from sample readily--slow dilatency.	$w_p$ --250 to 500% LL--250 to 600% PI--150 to 350 $\gamma$ --65 to 90 pcf G--1.8 to 2.3 $C_c/(1+e_0)$ = .3 to .4
	Sandy Peat	Organics either visible or inferred		Sand fraction visible. Thread weak and friable near PL; shrinks on air drying; low dry strength. Usually can squeeze water from sample readily--high dilatency--"gritty."	$w_p$ --100 to 400% LL--150 to 300% (plot below A line) PI--50 to 150 $\gamma$ --70 to 100 pcf G--1.8 to 2.4 $C_c/(1+e_0)$ = .2 to .3



TABLE 5 (continued)  
Soil Classification for Organic Soils

Category	Name	Organic Content (% by wt.)	Group Symbols (See Table 3)	Distinguishing Characteristics For Visual Identification	Range of Laboratory Test Values
ORGANIC SOILS	Clayey ORGANIC SILT	5 to 30% Organics either visible or inferred	OH	Often has strong H <sub>2</sub> S odor. Thread may be tough depending on clay fraction. Medium dry strength, slow dilatancy.	w <sub>p</sub> --65 to 200% LL--65 to 150% (usually plot at or near A line) PI-- 50 to 150 γ --70 to 100 pcf G--2.3 to 2.6 C <sub>c</sub> /(1+e <sub>0</sub> )=.20 to .35
	Organic SAND or SILT			Threads weak and friable near PL--or may not roll at all. Low dry strength; medium to high dilatancy.	w <sub>p</sub> --30 to 125% LL--30 to 100% (usually plot well below A line) PI--non-plastic to 40 γ --90 to 110 pcf G--2.4 to 2.6 C <sub>c</sub> /(1+e <sub>0</sub> )=.1 to .25
SLIGHTLY ORGANIC SOILS	SOIL FRACTION add slightly Organic	Less than 5% Organics combined visible and inferred	Depend upon inorganic fraction	Depend upon the characteristics of the inorganic fraction.	Depend upon inorganic fractions.

TABLE 6  
Typical Values of Soil Index Properties

	Particle Size and Gradation				Voids (1)						Unit Weight (2) (lb./cu.ft.)			
	Approximate Size Range (mm)		Approx. D <sub>10</sub> (mm)	Approx. Uniform Coefficient C <sub>u</sub>	Void Ratio		Porosity (%)		Dry Weight		Wet Weight		Submerged Weight	
	D <sub>max</sub>	D <sub>min</sub>			e <sub>cr</sub>	e <sub>sp</sub>	n <sub>max</sub>	n <sub>min</sub>	100% Mod. AASHTO	Min. loose	Max. dense	Min. loose	Max. dense	Min. loose
<b>GRANULAR MATERIALS</b>														
Uniform Materials														
a. Equal spheres (theoretical values)														
b. Standard Ottawa SAND														
c. Clean, uniform SAND (fine or medium)														
d. Uniform, inorganic SILT														
Well-graded Materials														
a. Silty SAND														
b. Clean, fine to coarse SAND														
c. Micaceous SAND														
d. Silty SAND & GRAVEL														
<b>MIXED SOILS</b>														
Sandy or silty CLAY														
Skip-graded silty CLAY with stones or sh. frags														
Well-graded GRAVEL, SAND, SILT & CLAY mixture														
<b>CLAY SOILS</b>														
CLAY (30% - 50% clay sizes)														
Colloidal CLAY (-0.002 mm - 50%)														
<b>ORGANIC SOILS</b>														
Organic SILT														
Organic CLAY (30% - 50% clay sizes)														

TABLE 6 (continued)  
Typical Values of Soil Index

- (1) Granular materials may reach  $e_{max}$  when dry or only slightly moist. Clays can reach  $e_{max}$  only when fully saturated.
- (2) Granular materials reach minimum unit weight when at  $e_{max}$  and with hygroscopic moisture only. The unit submerged weight of any saturated soil is the unit weight minus the unit weight of water.
- (3) Applicable for very compact glacial till. Unusually high unit weight values for tills are sometimes due to not only an extremely compact condition but to unusually high specific gravity values.
- (4) Applicable for hardpan.

General Note: Tabulation is based on  $G = 2.65$  for granular soil,  
 $G = 2.7$  for clays, and  $G = 2.6$  for organic soils.

TABLE 7

Weathering Classification

GRADE	SYMBOL	DIAGNOSTIC FEATURES
*Fresh	F	* No visible sign of decomposition or discoloration. * Rings under hammer impact.
*Slightly *Weathered	WS	* Slight discoloration inwards from open fractures, * otherwise similar to F.
*Moderately *Weathered	WM	* Discoloration throughout. Weaker minerals such * as feldspar decomposed. Strength somewhat less * than fresh rock but cores cannot be broken by * hand or scraped by knife. Texture preserved.
*Highly *Weathered	WH	* Most minerals somewhat decomposed. Specimens * can be broken by hand with effort or shaved * with knife. Core stones present in rock mass. * Texture becoming indistinct but fabric * preserved.
*Completely *Weathered	WC	* Minerals decomposed to soil but fabric and * structure preserved (Saprolite). Specimens * easily crumbled or penetrated.
*Residual *Soil	RS	* Advanced state of decomposition resulting in * plastic soils. Rock fabric and structure * completely destroyed. Large volume change.

TABLE 8  
Discontinuity Spacing

+))))))))))))))))))))))))))0))))))))))))))))))))))0))))))))))))))))))))))))),			
*Description for Structural	*	* Description for Joints,	*
*Features: Bedding,	*	* Faults or Other Fractures	*
*Foliation, or Flow Banding	* Spacing		
/))))))))))))))))))))))))))3))))))))))))))))))))))3))))))))))))))))))))))))1			
* Very thickly (bedded,	* More than 6 feet	* Very widely (fractured	* or jointed)
* foliated, or banded)			
* Thickly	* 2 - 6 feet	* Widely	
* Medium	* 8 - 24 inches	* Medium	
* Thinly	* 2-1/2 - 8 inches	* Closely	
* Very thinly	* 3/4 - 2-1/2 inches	* Very closely	
/))))))))))))))))))))))))))3))))))))))))))))))))))3))))))))))))))))))))))))1			
*Description for			
*Micro-Structural Features:			
*Lamination, Foliation, or		* Description for Joints,	*
*Cleavage	* Spacing	* Faults or Other Fractures	*
/))))))))))))))))))))))))))3))))))))))))))))))))))3))))))))))))))))))))))))1			
* Intensely (laminated,	* 1/4 - 3/4 inch	* Extremely close	
* foliated, or cleaved)			
* Very intensely	* Less than 1/4 inch		
.))))))))))))))))))))))))))2))))))))))))))))))))))2))))))))))))))))))))))))-			

fine-grained - grain diameter = 0.002 - 0.06mm

very fine-grained - grain diameter <0.002mm

(3) Use 10X hand lens if necessary to examine rock sample.

d. Hardness Classification. Describe as very soft, soft, etc. in accordance with Table 9 (from Reference 5), which shows range of strength values of intact rock associated with hardness classes.

e. Geological Classification. Identify the rock by geologic name and local name (if any). A simplified classification is given in Table 10. Identify subordinate constituents in rock sample such as seams or bands of other type of minerals, e.g., dolomitic limestone, calcareous sandstone, sandy limestone, mica schist. Example of typical description:

Fresh gray coarse moderately close fractured Mica Schist.

## 2. CLASSIFICATION BY FIELD MEASUREMENTS AND STRENGTH TESTS.

### a. Classification by Rock Quality Designation and Velocity Index.

(1) The Rock Quality Designation (RQD) is only for NX size core samples and is computed by summing the lengths of all pieces of core equal to or longer than 4 inches and dividing by the total length of the coring run. The resultant is multiplied by 100 to get RQD in percent. It is necessary to distinguish between natural fractures and those caused by the drilling or recovery operations. The fresh, irregular breaks should be ignored and the pieces counted as intact lengths. Depending on the engineering requirements of the project, breaks induced along highly anisotropic planes, such as foliation or bedding, may be counted as natural fractures. A qualitative relationship between RQD, velocity index and rock mass quality is presented in Table 11 (Reference 8, Predicting Insitu Modulus of Deformation Using Rock Quality Indexes, by Coon and Merritt).

(2) The velocity index is defined as the square of the ratio of the field compressional wave velocity to the laboratory compressional wave velocity. The velocity index is typically used to determine rock quality using geophysical surveys. For further guidance see Reference 9, Design of Surface and Near Surface Construction in Rock, by Deere, et al.

### b. Classification by Strength.

(1) Uniaxial Compressive Strength and Modulus Ratio. Determine the uniaxial compressive strength in accordance with ASTM Standard D2938, Unconfined Compressive Strength of Intact Rock Core Specimens. Describe the strength of intact sample tested as weak, strong, etc., in accordance with Figure 3 (Reference 10, The Point Load Strength Test, by Broch and Franklin).

(2) Point Load Strength. Describe the point load strength of specimen tested as low, medium, etc. in accordance with Figure 3. Point load strength tests are sometimes performed in the field for larger projects where rippability and rock strength are critical design factors. This simple field test can be performed on core samples and irregular rock specimens. The point

TABLE 9

Hardness Classification of Intact Rock

*CLASS*	HARDNESS	FIELD TEST	APPROXIMATE RANGE OF UNIAXIAL COMPRESSION STRENGTH (kg/cm. 2- (tons/ft. 2- )
* I *	* Extremely hard *	* Many blows with geologic hammer required to break intact specimen. *	* >2000 *
* II *	* Very hard *	* Hand held specimen breaks with hammer end of pick under more than one blow. *	* 2000- 1000 *
* III *	* Hard *	* Cannot be scraped or peeled with knife, hand held specimen can be broken with single moderate blow with pick. *	* 1000 - 500 *
* IV *	* Soft *	* Can just be scraped or peeled with knife. Indentations 1mm to 3mm show in specimen with moderate blow with pick. *	* 500 - 250 *
* V *	* Very soft *	* Material crumbles under moderate blow with sharp end of pick and can be peeled with a knife, but is too hard to hand-trim for triaxial test specimen. *	* 250 - 10 *







TABLE 10 (continued)  
Simplified Rock Classification

COMMON SEDIMENTARY ROCKS			
*Group	* Grain Size	* Composition	* Name
	* Variable	* Calcite and fossils	*Fossiliferous limestone
*Organic			*Dolomite
	* Medium to microscopic	* Calcite and appreciable dolomite	*limestone or dolomite
	* Variable	* Carbonaceous material	*Bituminous coal
		* Calcite	*Limestone
		* Dolomite	*Dolomite
*Chemical	* Microscopic	* Quartz	*Chert, Flint, etc.
		* Iron compounds with quartz	*Iron formation
		* Halite	*Rock salt
		* Gypsum	*Rock gypsum

TABLE 10 (continued)  
Simplified Rock Classification

COMMON METAMORPHIC ROCKS				
+))))))))))0))))))))),				
* Texture	*	Structure	*	*
/))))))))3))))))1				
* Foliated	*	Massive	*	*
* /))))))))3))))))1				
*Coarse Crystalline	*	Gneiss	*	Metaquartzite *
/))))))))3))))))1				
* (Sericite)	*	Marble	*	*
*Medium	*	(Mica)	*	Quartzite *
*Crystalline	*	Schist (Talc)	*	Serpentine *
* (Chlorite)	*	Soapstone	*	*
* (etc.)	*		*	*
/))))))))3))))))1				
*Fine to	*	Phyllite	*	Hornfels *
*Microscopic	*	Slate	*	Anthracite coal *
.))))))))2))))))-				

TABLE 11  
Engineering Classification For In Situ Rock Quality

+)))))))))))))))))) <b>0</b> )))))))))))))))))) <b>0</b> )))))))))))))))))) <b>,</b>	*      ROD %      *	*      VELOCITY INDEX      *	*      ROCK MASS QUALITY      *
*)))))))))))))))))) <b>3</b> )))))))))))))))))) <b>3</b> )))))))))))))))))) <b>1</b>	*      90 - 100      *	*      0.80 - 1.00      *	*      Excellent      *
*      *      *	*      75 - 90      *	*      0.60 - 0.80      *	*      Good      *
*      *      *	*      50 - 75      *	*      0.40 - 0.60      *	*      Fair      *
*      *      *	*      25 - 50      *	*      0.20 - 0.40      *	*      Poor      *
*      *      *	*      0 - 25      *	*      0 - 0.20      *	*      Very Poor      *
.)))))))))))))))))) <b>2</b> )))))))))))))))))) <b>2</b> )))))))))))))))))) <b>-</b>			

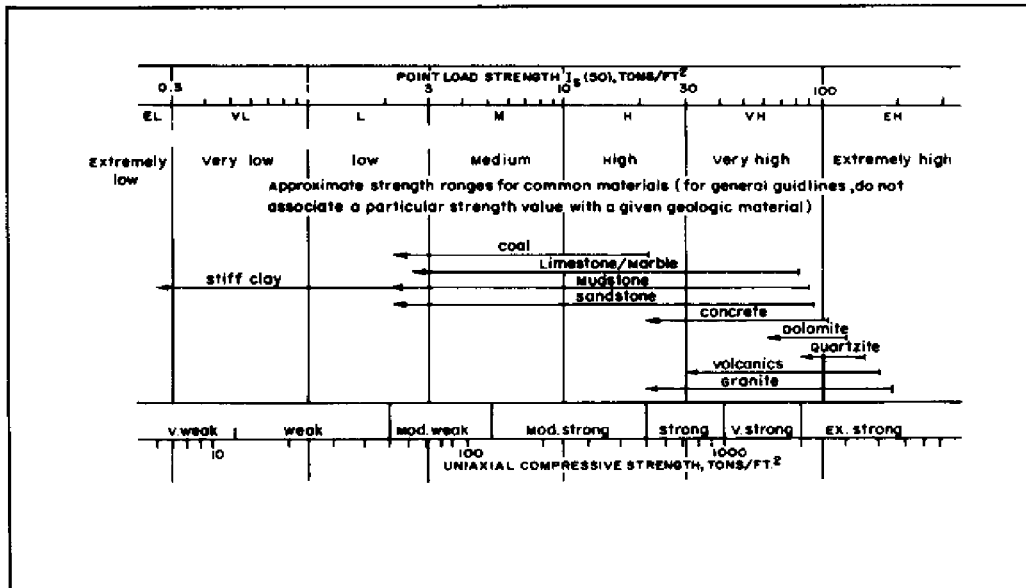

FIGURE 3  
Strength Classification

load strength index is defined as the ratio of the applied force at failure to the squared distance between loaded points. This index is related to the direct tensile strength of the rock by a proportionality constant of 0.7 to 1.0 depending on the size of sample. Useful relationships of point load tensile strength index to other parameters such as specific gravity, seismic velocity, elastic modulus, and compressive strength are given in Reference 11, Prediction of Compressive Strength from Other Rock Properties, by DiAndrea, et al. The technique for performing the test is described in Reference 9.

c. Classification by Durability. Short-term weathering of rocks, particularly shales and mudstones, can have a considerable effect on their engineering performance. The weatherability of these materials is extremely variable, and rocks that are likely to degrade on exposure should be further characterized by use of tests for durability under standard drying and wetting cycle (see Reference 12, Logging Mechanical Character of Rock, by Franklin, et al.). If, for example, wetting and drying cycles reduce shale to grain size, then rapid slaking and erosion in the field is probable when rock is exposed (see Reference 13, Classification and Identification of Shales, by Underwood).

3. ENGINEERING AND PHYSICAL PROPERTIES OF ROCK. A preliminary estimate of the physical and engineering properties can be made based on the classification criteria given together with published charts, tables and correlations interpreted by experienced engineering geologists. (See Reference 8; Reference 13; Reference 14, Slope Stability in Residual Soils, by Deere and Patton; Reference 15, Geological Considerations, by Deere; Reference 16, Engineering Properties of Rocks, by Farmer.) Guidance is provided in Reference 14 for description of weathered igneous and metamorphic rock (residual soil, transition from residual to saprolite, etc.) in terms of RQD, percent core recovery, relative permeability and strength. Typical strength parameters for weathered igneous and metamorphic rocks are also given in Reference 14. Guidance on physical properties of some shales is given in Reference 13.

## Section 6. SPECIAL MATERIALS

1. GENERAL CLASSIFICATION AND TYPICAL ENGINEERING IMPLICATIONS. See Table 12 for general classification and typical engineering implications of special materials that influence foundation design.

2. EXPANSIVE SOILS.

a. Characteristics. Expansive soils are distinguished by their potential for great volume increase upon access to moisture. Soils exhibiting such behavior are mostly montmorillonite clays and clay shales.

b. Identification and Classification. Figure 4 (Reference 17, Shallow Foundations, by the Canadian Geotechnical Society) shows a method based on Atterberg limits and grain size for classifying expansive soils. Activity of clay is defined as the ratio of plasticity index and the percent by weight finer than two microns ( $2[\mu]$ ). The swell test in a one dimensional consolidation test (see Chapter 3) or the Double Consolidometer Test (Reference 18, The Additional Settlement of Foundations Due to Collapse of Structures of

TABLE 12  
 Identification and Characteristics of Special Materials

Material	Geographic/Geomorphic Features	Engineering Conditions
"Quick Clay"	<ul style="list-style-type: none"> <li>• Marine or brackish water clay composed of glacial rock flour that is elevated above sea level.</li> <li>• Generally confined to far north areas; Eastern Canada, Alaska, Scandinavia.</li> </ul>	<ul style="list-style-type: none"> <li>• Severe loss of strength when disturbed by construction activities or seismic ground shaking.</li> <li>• Replacement of formation water containing dissolved salt with fresh water results in strength loss.</li> <li>• Produces landslide prone areas (Anchorage, Alaska).</li> </ul>
Hydraulic Fills	<ul style="list-style-type: none"> <li>• Coastal facilities, levees, dikes, tailings dams</li> </ul>	<ul style="list-style-type: none"> <li>• High void ratio</li> <li>• Uniform gradation but variable grain sizes within same fill</li> <li>• High liquefaction potential</li> <li>• Lateral spreading</li> <li>• Easily eroded</li> </ul>
Collapsing Soil	<ul style="list-style-type: none"> <li>• Desert arid and semi-arid environment</li> <li>• Alluvial valleys, plays, loess</li> </ul>	<ul style="list-style-type: none"> <li>• Loss of strength when wetted</li> <li>• Differential settlement</li> <li>• Low density</li> <li>• Moisture sensitive</li> <li>• Gypsum/Anhydrite often present</li> </ul>

TABLE 12 (continued)  
Identification and Characteristics of Special Materials

Material	Geographic/Geomorphic Features	Engineering Conditions
Submarine Soils	<ul style="list-style-type: none"> <li>• Continental shelf deposits at water depths up to several hundred feet.</li> <li>• Submarine canyons, turbidity flows, deltaic deposits, abyssal plain</li> </ul>	<ul style="list-style-type: none"> <li>• Distribution and physical properties of sand, silt, and clay may change with time and local geologic conditions.</li> <li>• Shelf deposits have few unique characteristics requiring modification of soil mechanics principals.</li> <li>• Local areas, such as the Gulf of Mexico have weak, underconsolidated deposits.</li> <li>• Deep sea calcareous deposits have water contents up to 100% and shear strengths up to about 220 psf.</li> <li>• Deep sea silty clays have average water contents of 100-200% and shear strengths of 35-75 psf.</li> <li>• Deep sea deposits are normally consolidated but near shelf deposits may be underconsolidated.</li> </ul>
Lateritic Soils	<ul style="list-style-type: none"> <li>• Tropical rainforest and savanna</li> <li>• Deep residual soil profile</li> <li>• Shield and sedimentary cover outside shield in South and Central America, Central and West Africa, southeast Asia, and other parts of the world.</li> </ul>	<ul style="list-style-type: none"> <li>• Loss of soil strength with time</li> <li>• High void ratio/permeability</li> <li>• Aggregate deterioration</li> <li>• Variable moisture content</li> <li>• Shrinkage cracks</li> </ul>



TABLE 12 (continued)  
 Identification and Characteristics of Special Materials

Material	Geographic/Geomorphic Features	Engineering Conditions
Lateritic Soils (cont'd)		<ul style="list-style-type: none"> <li>• Easily compacts</li> <li>• Shear characteristics somewhere between sand and silt</li> <li>• Landslide prone</li> <li>• Depth of wetting affects slope stability</li> <li>• Varied foundation conditions</li> </ul>
Limestone and Coral	<ul style="list-style-type: none"> <li>• Humid tropics and subtropics, island environment.</li> <li>• Karst topography accelerated in humid climates.</li> <li>• limestone that are cavernous or prone to cavity formations are widely distributed throughout the world in countries of arid and humid climates. In the U. S., cavernous limestone is found in Kentucky, Pennsylvania, California, Indiana, Michigan, New Mexico, Texas, and Virginia.</li> </ul>	<ul style="list-style-type: none"> <li>• Solution cavities</li> <li>• Extreme variations in porosity</li> <li>• Void ratios in coral up to 2</li> <li>• Chimney-like sinkholes and collapse structures</li> <li>• Slump failures, raveling</li> <li>• Rock settlement and consolidation</li> <li>• Piles or bridging often required</li> </ul>

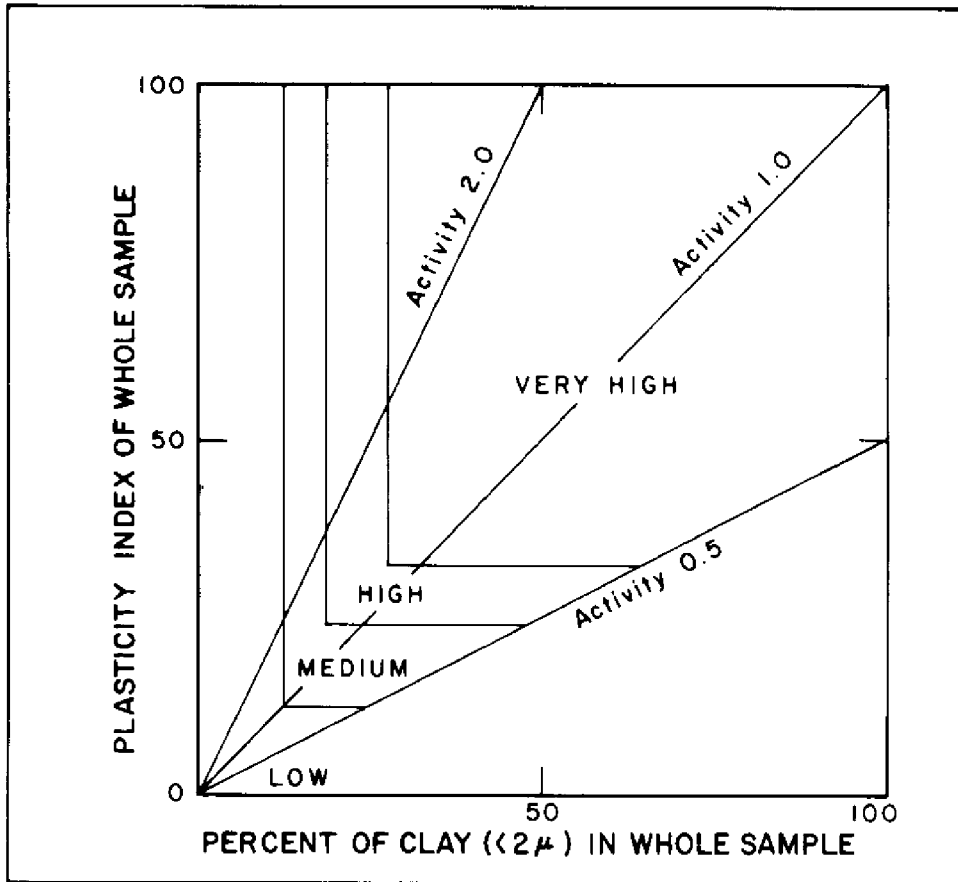

FIGURE 4  
Volume Change Potential Classification for Clay Soils

Sandy Soils on Wetting, by Jennings and Knight) is used for estimating the swell potential.

### 3. COLLAPSING SOILS

a. Characteristics. Collapsing soils are distinguished by their potential to undergo large decrease in volume upon increase in moisture content even without increase in external loads. Examples of soils exhibiting this behavior are loess, weakly cemented sands and silts where cementing agent is soluble (e.g., soluble gypsum, halite, etc.) and certain granite residual soils. A common feature of collapsible soils is the loose bulky grains held together by capillary stresses. Deposits of collapsible soils are usually associated with regions of moisture deficiency.

b. Identification and Classification. Detailed geologic studies could identify potentially collapsible soils. Figure 5 (Reference 19, Research Related to Soil Problems of the Arid Western United States, by Holtz and Gibbs) provides guidance for identifying the potential for collapse for clayey sands and sandy clays found in the western United States. For cemented soils and nonplastic soils, criteria based on consolidometer tests are more applicable as illustrated in Figure 6 (Reference 20, A Guide to Construction on or with Materials Exhibiting Additional Settlements Due to Collapse of Grain Structure, by Jennings and Knight; and Reference 21, The Origin and Occurrence of Collapsing Soil, by Knight). The potential for collapse is also evaluated in the field by performing standard plate load tests (ASTM D1194, Bearing Capacity of Soil for Static Load on Spread Footings) under varied moisture environments. For further guidance see Reference 22, Experience with Collapsible Soil in the Southwest, by Beckwith.

### 4. PERMAFROST AND FROST PENETRATION.

a. Characteristics. In non-frost susceptible soil, volume increase is typically 4% (porosity 40%, water volume increase in turning to ice = 10%, total heave =  $40\% \times 10\% = 4\%$ ). In susceptible soil heave is much greater as water flows to colder zones (forming ice lenses). The associated loss of support upon thaw can be more detrimental to structures than the heave itself.

b. Classification. Silts are the most susceptible to frost heave. Soils of types SM, ML, GM, SC, GC, and CL are classified as having frost heave potential.

c. Geography. Figure 7 (Reference 23, National Oceanic and Atmospheric Administration) may be used as a guide for estimating extreme depth of frost penetration in the United States.

### 5. LIMESTONE AND RELATED MATERIALS.

a. Characteristics. Limestone, dolomite, gypsum and anhydrite are characterized by their solubility and thus the potential for cavity presence and cavity development. Limestones are defined as those rocks composed of more than 50% carbonate minerals of which 50% or more consist of calcite and/or aragonite. Some near shore carbonate sediments (also called limestone, marl, chalk) could fit this description. Such sediments are noted for erratic degrees of induration, and thus variability in load supporting capacity and

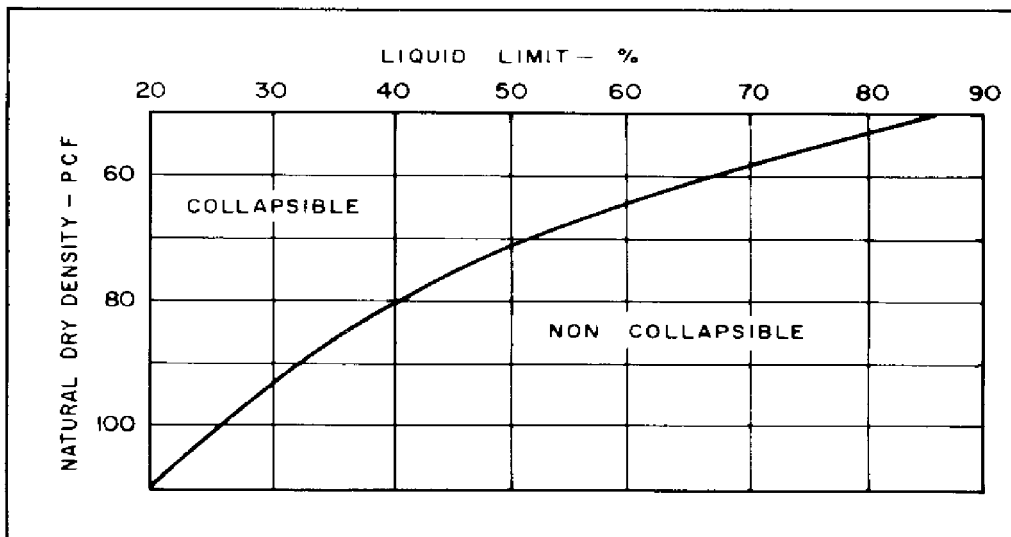

FIGURE 5  
Criterion for Collapse Potential

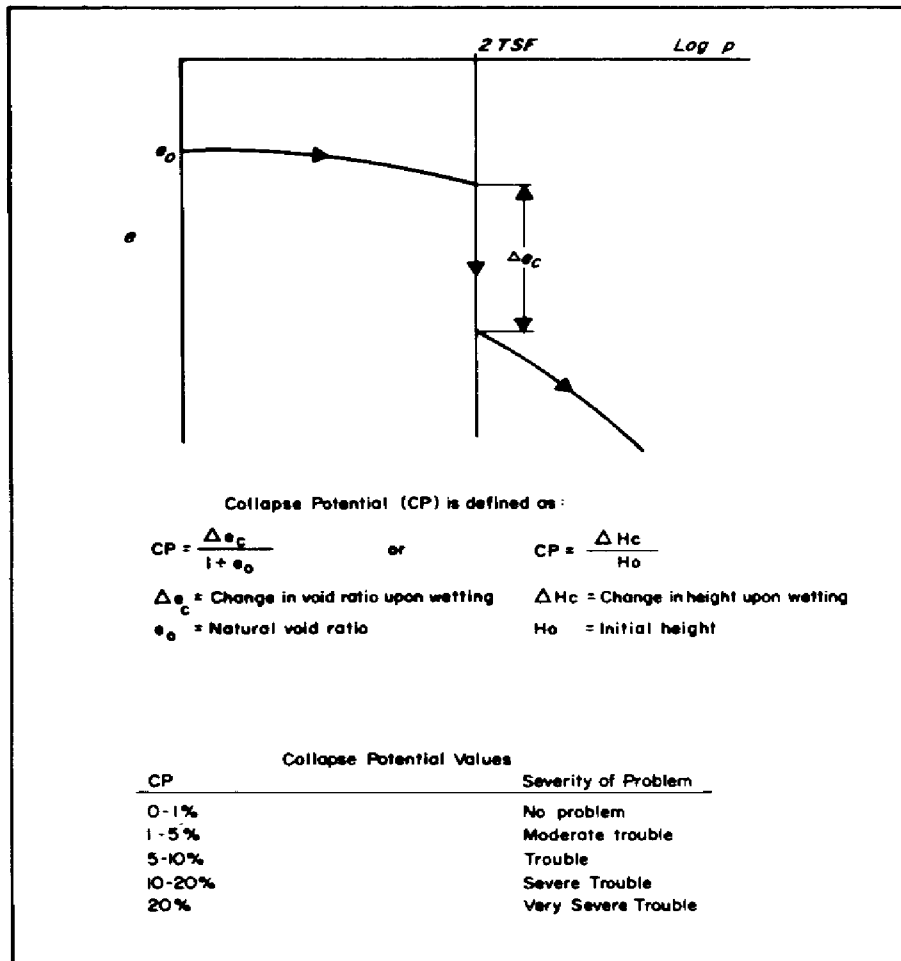

FIGURE 6  
 Typical Collapse Potential Test Results

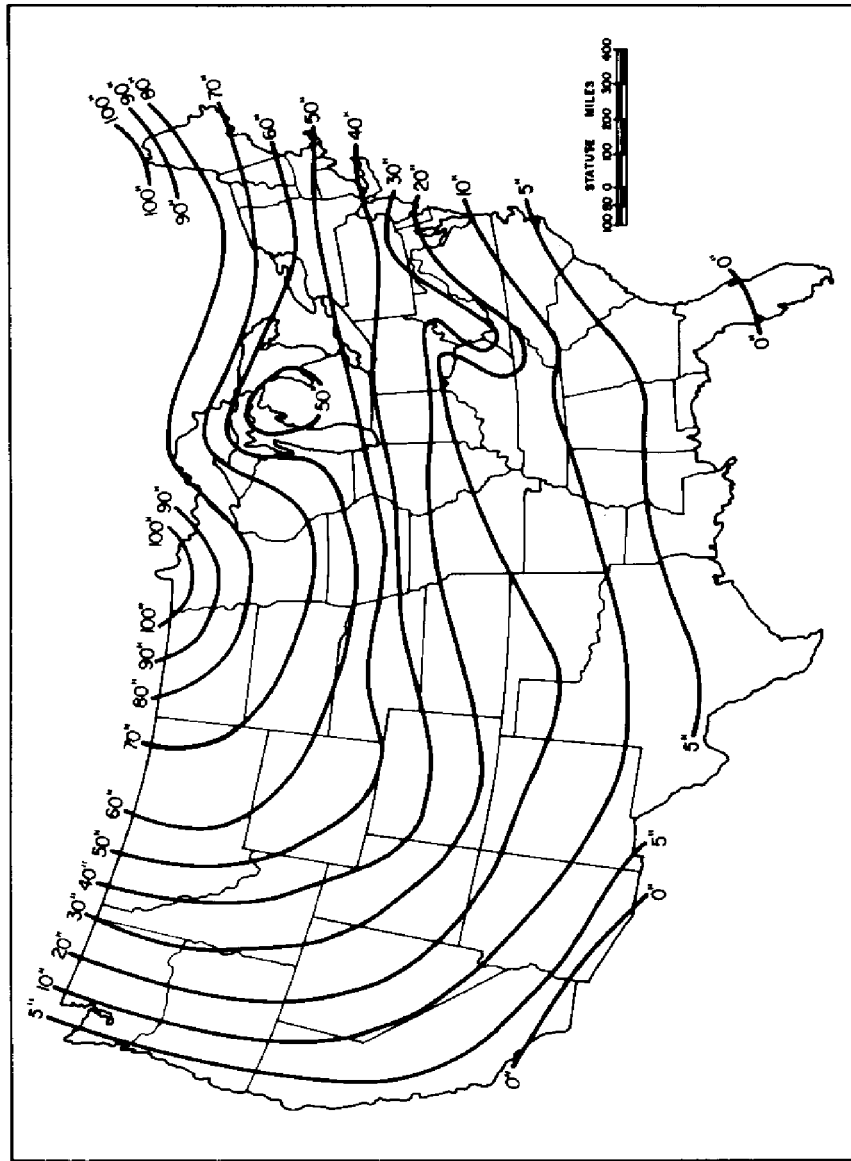

FIGURE 7  
Extreme Frost Penetration (in Inches) Based Upon State Average

uncertainty in their long-term performance under sustained loads. The most significant limestone feature is its solubility. An extremely soluble one can be riddled with solution caves, channels, or other open, water, or clay filled features.

b. Identification. Presence of solution features may be checked by geological reconnaissance, drilling, and other forms of bedrock verification. Geophysical techniques, including shallow seismic refraction, resistivity and gravimetry are often found to be valuable supplements.

c. Coral and Coral Formation.

(1) Origin. Living coral and coralline debris are generally found in tropical regions where the water temperature exceeds 20deg.C. Coral is a term commonly used for the group of animals which secrete an outer skeleton composed of calcium carbonate, and which generally grow in colonies. The term "coral reef" is often applied to large concentrations of such colonies which form extensive submerged tracts around tropical coasts and islands. In general, coralline soils deposited after the breakdown of the reef, typically by wave action, are thin (a few meters thick) and form a veneer upon cemented materials (limestones, sandstones, etc.).

(2) Geological Classification. Because the granular coralline and algal materials are derived from organisms which vary in size from microscopic shells to large coralheads several meters in diameter, the fragments are broadly graded and range in size from boulders to fine-grained muds. Similarly, the shape of these materials varies from sharp, irregular fragments to well-rounded particles. Coralline deposits are generally referred to as "biogenic materials" by geologists. When cemented, they may be termed "reefrock," or "beachrock," or other names which imply an origin through cementation of particles into a hard, coherent material.

(3) Characteristics. Coralline deposits are generally poor foundation materials in their natural state because of their variability and susceptibility to solution by percolating waters, and their generally brittle nature. Coralline materials are often used for compacted fill for roads and light structures. Under loads, compaction occurs as the brittle carbonate grains fracture and consolidate. They can provide a firm support for mats or spread footings bearing light loads, but it is necessary to thoroughly compact the material before using it as a supporting surface. Heavy structures in coral areas are generally supported on pile foundations because of the erratic induration. Predrilling frequently is required.

Because of extreme variability in engineering properties of natural coral formations, it is not prudent to make preliminary engineering decisions on the basis of "typical properties." Unconfined compression strengths of intact specimens may range from 50 tons/ft.2- to 300 tons/ft.2- , and porosity may range from less than 40% to over 50%.

For further guidance see Reference 24, Failure in Limestone in Humid Subtropics, by Sowers, which discusses factors influencing construction in limestone; and Reference 25, Terrain Analysis - A Guide to Site Selection Using Aerial Photographic Interpretation, by Way.

## 6. QUICK CLAYS.

a. Characteristics. Quick clays are characterized by their great sensitivity or strength reduction upon disturbance.

All quick clays are of marine origin. Because of their brittle nature, collapse occurs at relatively small strains. Slopes in quick clays can fail without large movements. For further guidance see Reference 5 and Reference 26, Quick Clays and California: No Quick Solutions, by Anne.

b. Identification. Quick clays are readily recognized by measured sensitivities greater than about 15 and by the distinctive, strain-softening shape of their stress-strain curves from strength or compressibility tests.

## 7. OTHER MATERIALS AND CONSIDERATIONS.

a. Man-Made Fills. Composition and density are the main concerns. Unless these can be shown to be non-detrimental to the performance of the foundation, bypassing with deep foundations, or removal and replacement are in order.

Sanitary landfills may undergo large settlements under self weight as well as under structural loads. Guidelines on the evaluation of settlement and other foundation considerations for sanitary landfills are given in DM-7.3, Chapter 3.

b. Chemically Reactive Soils. For foundation construction, the main concerns usually are corrosion and gas generation. Corrosion potential is determined in terms of pH, resistivity, stray current activity, groundwater position, chemical analysis, etc.; and a compatible foundation treatment, e.g., sulfate resistant concrete, lacquers, creosote, cathodic protection, etc., is prescribed. For gas concentration, organic matter content and field testing for gas are usually performed. If gas generation is expected, some form of venting system is designed (see Chapter 2). The potential presence of noxious or explosive gases should be considered during the construction excavations and tunneling.

c. Lateritic Soils. Lateritic soils are found in tropical climates throughout the world. Typical characteristics are shown in Table 12. For further guidance see Reference 27, Laterite Soil Engineering, by Gidigas; Reference 28, Laterite Genesis, Location, Use, by Persons; Reference 29, Engineering Study of Laterite and Lateritic Soils in Connection with Construction of Roads, Highways and Airfields, by the U.S. Agency for International Development; Reference 30, Laterite, Lateritic Soils and Other Problem Soils of Africa, by the U.S. Agency for International Development; and Reference 31, Laterite and Lateritic Soils and Other Problem Soils of the Tropics, by the U.S. Agency for International Development.

d. Submarine Soils. Typical characteristics are shown in Table 12. Further guidance may be found in Reference 32, Engineering Properties of Submarine Soils: State-of-the-Art Review, by Noorany and Gizienski.



## REFERENCES

1. Departments of the Army and Air Force, Soils and Geology, Procedures for Foundation Design of Buildings and Other Structures (Except Hydraulic Structures), TM 5-818-1/AFM 88-3, Chapter 7, Washington, DC, 1979.
2. Mitchell, J. K. and Lunne, T. A., Cone Resistance as Measure of Sand Strength, Journal of the Geotechnical Engineering Division, ASCE, Vol. 104, No. GT7, 1978.
3. Terzaghi, K., and Peck, R. B., Soil Mechanics in Engineering Practice, John Wiley & Sons, Inc., New York, 1967.
4. Ayers J., and Plum, R., Unpublished work.
5. Hough, B. K., Basic Soils Engineering, Ronald Press, New York, 1969.
6. ISRM Working Party, Suggested Methods of the Description of Rock Masses Joints and Discontinuities, International Society of Rock Mechanics Second Draft of Working Party, Lisbon, 1975.
7. Geological Society of America, Rock Color Chart.
8. Coon, J. H. and Merritt, A. H., Predicting Insitu Modulus of Deformation Using Rock Quality Indexes, Determination of the Insitu Modulus of Deformation of Rock, STP 457, ASTM 1970.
9. Deere, D. U., Hendron A. J. Jr., Patton, F. D. and Cording, E. J., Design of Surface and Near Surface Construction in Rock, Proceedings, Eighth Symposium on Rock Mechanics, MN., 1966.
10. Broch, E. and Franklin, J. A., The Point Load Strength Test, International Journal of Rock Mechanics and Mining Science, Pergamon Press, Vol. 9, pp 669 - 697, 1972.
11. DiAndrea, D. V., Fischer, R. L., and Fogelson, D. E., Prediction of Compressive Strength from Other Rock Properties, U. S. Bureau of Mines, Report Investigation 6702, p 23, 1967.
12. Franklin, J. A., Broch, E., and Walton, G., Logging Mechanical Character of Rock, Transactions, Institution of Mining and Metallurgy, A 80, A1-A9, 1971.
13. Underwood, L. B., Classification and Identification of Shales, Journal of Soil Mechanics and Foundation Division, ASCE, Vol. 93, No. SM6, 1962.
14. Deere, D. U. and Patton, F. D., Slope Stability in Residual Soils, Proceedings of the Fourth Panamerican Conference on Soil Mechanics and Foundation Engineering, San Juan, Volume 1, pp 87-100, 1971.
15. Deere, D. U., Geologic Considerations, Rock Mechanics in Engineering Practice, Stagg, K. G. and Zienkiewics, O. C., ed., John Wiley and Sons, New York, Chapter 1, 1969.

16. Farmer, I. W., Engineering Properties of Rocks, E & FN Spon LTP, London, 1968.
17. The Canadian Geotechnical Society, Shallow Foundations, Part 2, Canadian Foundation Engineering Manual, 1978.
18. Jennings, J. E. and Knight, K., The Additional Settlement of Foundations Due to Collapse of Structures of Sandy Soils on Wetting, Proceeding of the Fourth International Conference on Soil Mechanics and Foundation Engineering, London, 1957.
19. Holtz, W. G. and Gibbs, H. J., Research Related to Soil Problems of the Arid Western United States, Proceedings of the Third Panamerican Conference on Soil Mechanics and Foundation Engineering, Caracas, 1967.
20. Jennings, J. E. and Knight, K., A Guide to Construction on or With Materials Exhibiting Additional Settlements Due to Collapse of Grain Structure, Proceedings of the Sixth Regional Conference for Africa on Soil Mechanics and Foundation Engineering, pp 99-105, 1975.
21. Knight, K., The Origin and Occurrence of Collapsing Soil, Proceedings of the Third Regional Conference of Africa on Soil Mechanics and Foundation Engineering, Vol. 1, pp 127-130, 1963.
22. Beckwith, G. H., Experience with Collapsible Soil in the Southwest, ASCE Conference, Arizona Section, 1979.
23. National Oceanic and Atmospheric Administration, Environmental Data and Information Service, Asheville, NC.
24. Sowers, F. G., Failure in Limestone in Humid Subtropics, Journal of the Geotechnical Engineering Division, ASCE, Vol. 101, No. GT8, 1975.
25. Way, S. D., Terrain Analysis - A Guide to Site Selection Using Aerial Photographic Interpretation, Dowden, Hutchinson & Ross, Inc., Stroudsburg, PA., 1973.
26. Anne, Q. A., Quick Clays and California: No Quick Solutions, Focus on Environmental Geology, Ronald Rark, ed., pp 140-145, 1973.
27. Gidigasu, M. D., Laterite Soil Engineering, Elsevier Scientific Publishing Co., 1976.
28. Persons, S. B., Laterite Genesis, Location, Use, Plenum Press, 1970.
29. U.S. Agency for International Development, Engineering Study of Laterite and Lateritic Soils in Connection With Construction of Roads, Highways and Airfields, Southeast Asia, 1969.
30. U.S. Agency for International Development, Laterite, Lateritic Soils and Other Problem Soils of Africa, 1971.

31. U.S. Agency for International Development, Laterite and Lateritic Soils and Other Problem Soils of the Tropics, 1975.
32. Noorany, I. and Gizienski, S. F., Engineering Properties of Submarine Soils: State-of-the-Art Review, Journal of the Soil Mechanics and Foundation Division, ASCE, Vol. 96, No. SM5, 1970.
33. Naval Facilities Engineering Command, Design Manuals (DM)
  - DM-5.04 Pavements
  - DM-21 series Airfield Pavement

Government agencies may obtain copies of design manuals from the U. S. Naval Publications and Forms Center, 5801 Tabor Avenue, Philadelphia, Pennsylvania 19120. Nongovernment agencies and commercial firms may obtain copies from the Superintendent of Documents, U.S. Government Printing Office, Washington, D.C. 20402.

CHAPTER 2. FIELD EXPLORATION, TESTING, AND INSTRUMENTATION

Section 1. INTRODUCTION

1. SCOPE. This chapter contains information on exploration methods including use of air photos and remote sensing, geophysical methods, test pits, test borings, and penetrometers. Also presented is information on methods of sampling, measuring in situ properties of soil and rock, field measurements, and geotechnical monitoring equipment.

2. RELATED CRITERIA. For other criterial related to exploration and sampling, see the following sources:

Subject	Sources
Soil Exploration and Subgrade Testing.....	NAVFAC DM-5.04
Field Pumping Tests.....	NAVFAC P-418

3. PLANNING FOR FIELD INVESTIGATIONS. The initial phase of field investigations should consist of detailed review of geological conditions at the site and in its general environs. This should include a desk top study of available data including remote sensing imagery, aerial photography, and a field reconnaissance. The information obtained should be used as a guide in planning the exploration.

To the extent possible, borings should be supplemented by lower cost exploration techniques such as test pits, probes, seismic refraction surveys, and electrical resistivity surveys. This is particularly true in the offshore environment where borings are exceptionally expensive.

Information on boring layout is given in Section 5 and a sample boring log is given in Figure 1. Guidance on exploration techniques is given in Sections 5 and 6.

It should be noted that NAVFAC has a Geotechnical Data Retrieval System. To optimize its use, the U.S. Navy encourages utilization of its format on Navy projects. Details relative to this can be found in Reference 1, Geotechnical Data Retrieval System, by NAVFAC.

4. EXPLORATION PHASES. Project exploration can generally have three phases: reconnaissance/feasibility exploration; preliminary exploration; and detailed/final exploration. Additional exploration may be required during or after construction. Frequently, all preconstruction phases are combined into a single exploration effort.

a. Reconnaissance/Feasibility. Reconnaissance includes a review of available topographic and geologic information, aerial photographs, data from previous investigations, and site examination. Geophysical methods are applicable in special cases. Reconnaissance/feasibility frequently reveals difficulties which may be expected in later exploration phases and assists in determining the type, number and locations of borings required.

TEST BORING LOG										BORING NO.	
PROJECT										SHT. NO. 1 OF	
CLIENT										PROJ. NO.	
BORING CONTRACTOR										ELEVATION	
GROUND WATER										DATUM	
DATE	TIME	DEPTH	CASING	TYPE	HSA	S.S.	CORE	TUBE	DATE START		
12-1-78	1400	5'	5'		4"	2"	2-1/8"	3"	DATE FINISH		
				WT.		140LB.			DRILLER		
				FALL		30"			INSPECTOR		
DEPTH FT.	CASING BLOWS	SAMPLE NO.	BLOWS ON SAMPLE SPOON PER 6"	SYMBOL	IDENTIFICATION				REMARKS		
1		S-1	1	■	Soft dark brown organic CLAY (OH), wet						
			2								
2			2	■	Soft brown Clayey SILT (ML), moist						
			2								
3		U-1	P	■	Well graded brown-gray GRAVELS, some sand (GW)				▼		
			U								
4			S								
			H								
5			9	■	Medium dense, gray coarse to fine SAND, trace silt, trace fine gravel (SW)						
			11								
6		S-2	13								
			18								
7				■	Well graded brown-gray GRAVELS, some sand (GW)						
8											
9											
10											
11				■	SANDSTONE, Brown fine grained slightly weathered, hard, medium fractured, with brown stains				R-1 Rec = 80% RQD = 70% 12:50 = Start Run 1 13:10 = Pull Run 1		
12		R-1									
13											
14											
15				BOTTOM OF BORING @ 14'0"							
16				<u>SYMBOLS:</u>							
17				■	SPLIT SPOON SAMPLE						
18				■	UNDISTURBED SAMPLE						
19				■	ROCK CORED						
20				▼	WATER LEVEL						
21											
22											
23											

FIGURE 1  
Sample Boring Log

b. Preliminary Exploration. This may include borings to recover samples for identification tests only.

c. Detailed Exploration. This phase normally includes borings, disturbed and undisturbed sampling for laboratory testing, standard penetration resistances, and other in situ measurements. At critical sites it may also include test pits, piezometer measurements, pumping tests, etc.

d. Construction/Post Construction Phases. Further evaluation of foundation conditions may be required during the construction phase. Monitoring of the site or structure may be necessary throughout the construction and post construction phases.

## Section 2. PUBLISHED SOIL AND GEOLOGICAL MAPS

1. SOURCES. Data on the physical geology of the United States are available in maps and reports by government agencies, universities, and professional societies (see Table 1). These sources often contain geological information on foreign countries.

2. PREVIOUS INVESTIGATIONS. For studies in developed areas, collect information from previous work on foundations and subsurface conditions.

a. Shipyard or Waterfront Areas. These locations often have undergone cycles of expansion and reconstruction with older foundations remaining buried in place. Records of former construction may contain information on borings, field tests, groundwater conditions, and potential or actual sources of trouble.

b. Evaluation. Review of data from previous work should receive the greatest attention of any phase in a reconnaissance investigation.

## Section 3. REMOTE SENSING DATA METHODS

1. SOURCES. Remote sensing data are acquired by imagery recovery devices and their transporting media. Aerial photographs are the most common type with coverage of almost the entire United States available at scales from 1:12,000 to 1:80,000. With the advent of improving technology, space programs and data gathering satellites, a wealth of other remote sensed data are now available for use. Table 2 summarizes the types of data most commonly used in engineering studies. Photos at larger scale up to 1:2000 are available for some locations from state agencies and commercial aero-photogrammetric firms.

2. UTILIZATION. Use of photographs and mosaics is routine in most large engineering studies such as highway and airfield work. Other forms of remote sensing data are used on a more selective basis when required. For a complete description on the use of imagery in earthquake analysis, see Reference 2, Imagery in Earthquake Analysis, by Glass and Slemmons. For unfamiliar sites, the air photographs aid in planning and layout of an appropriate boring program.

TABLE 1

Sources of Geological Information

Series	Description of Material
*U.S. Geological Survey (USGS)	* Consult USGS Index of Publications from Superintendent of Documents, Washington, D.C. Order publications from Superintendent of Documents. Order maps from USGS, Washington, D.C. Contact regional distribution offices or information.
* Geological index map	* Individual maps of each state showing coverage and sources of all published geological maps.
* Folios of the Geological Atlas of the United States	* Contains maps of bedrock and surface materials for many important urban and seacoast areas. When out of print, obtain folios through suppliers of used technical literature.
* Geological Quadrangle Maps of United States	* This series supplants the older geological folios including areal or bedrock geology maps with brief descriptive text. Series is being extended to cover areas not previously investigated.
* Bulletins, professional papers, circulars, annual reports, monographs	* General physical geology emphasizing all aspects of earth sciences, including mineral and petroleum resources, hydrology and seismicity. Areal and bedrock geology maps for specific locations included in many publications.
* Water supply papers	* Series includes papers on groundwater resources in specific localities and are generally accompanied by description of subsurface conditions affecting groundwater plus observations of groundwater levels.
* Topographic maps	* Topographic contour maps in all states, widespread coverage being continually expanded.
* Libraries	* Regional office libraries contain geological and seismological information from many sources. Data on foreign countries are often suitable.

TABLE 1 (continued)  
Sources of Geological Information

+))))))))))0))))))))))	Description of Material	*
* Series		*
/))))))))))3))))))))))		1
*National	*Consult Catalog 1, Atlantic and Gulf Coasts; 2, Pacific	*
*Oceanic and	* Coast, 3, Alaska; 4, Great Lakes; and 5, Bathymetric Maps*	*
*Atmospheric	* and Special Charts. Order from Distribution Service,	*
*Administration	* National Ocean Survey, Riverdale, Maryland 20840	*
*(NOAA),	*	*
*National	*	*
*Ocean Survey	*	*
*(NOS)	*	*
*	*	*
* Nautical	*Charts of coastal and inland waterways showing available	*
* Charts	* soundings of bottom plus topographic and cultural	*
*	* features adjacent to the coast or waterways.	*
/))))))))))3))))))))))		1
*U.S.	*Consult "List of Published Soil Surveys," USDA, Soil	*
*Department of	* Conservation Service, January 1980 (published annually).	*
*Agriculture	* Listing by states and countries.	*
*(USDA), Soil	*	*
*Conservation	*	*
*Service.	*	*
*	*	*
* Soil maps	*Surveys of surface soils described in agricultural terms.	*
* and reports	* Physical geology summarized. Excellent for highway or	*
*	* airfield investigations. Coverage mainly in midwest,	*
*	* east, and southern United States.	*
/))))))))))3))))))))))		1
*State	*Most states provide excellent detailed local geological	*
*Geological	* and reports covering specific areas or features in the	*
*Surveys/State	* maps publications of the state geologists. Some offices	*
*Geologist's	* are excellent sources of information on foreign	*
*Office	* countries.	*
/))))))))))3))))))))))		1
*Geological	*Write for index to GSA, P. O. Box 9140, 3300 Penrose	*
*Society of	* Place, Boulder, Colorado, 80302.	*
*America (GSA)	*	*
*	*	*
* Monthly	*Texts cover specialized geological subjects and intensive	*
* bulletins,	* investigations of local geology. Detailed geological	*
* special	* maps are frequently included in the individual articles.	*
* papers, and	*	*
* memoirs.	*	*
*	*	*
* Geological	*Publications include general geological maps of North and	*
* maps	* South America, maps of glacial deposits, and Pleistocene	*
*	* aeolian deposits.	*
.)))))))))2))))))))))		-



TABLE 1 (continued)  
Sources of Geological Information

+))))))0)))))) * Series *	Description of Material	* * 1
/))))))3)))))) *Library of * *Congress * * * * * /))))))3))))))	Maintains extensive library of U.S. and foreign geologic reports by geographical area. Inquiry to Library of Congress, 10 First Street, Washington, D. C., 20540.	* * * * 1
*Worldwide * *National * *Earth- * *Science * *Agencies *	For addresses consult "Worldwide Directory of National Earth-Science Agencies," USGS Circular 716, 1975	* * * * *
.)))))2))))))		* -

TABLE 2  
Remote Sensing Data

TYPE	DESCRIPTION AND GENERAL USE	AVAILABILITY
Aerial Photography	<p>Available in 9-inch frames with overlap for stereoscopic viewing. Valuable because of high resolution and available scales could range from 1:12,000 (or larger) to 1:80,000. Photos used extensively for topographic and/or geologic mapping, drainage patterns, and other uses include identifying location of existing structures, vegetation, access routes and site locations for planned explorations.</p> <p>Imagery obtained by satellite which flies in circular orbit 570 miles above Earth's surface and circles Earth about 14 times a day. Gives repetitive coverage every 18 days. The primary sensor is the multispectral scanner (MSS) which acquires images 115 miles per side in four spectral bands. The four bands are:</p> <p>BAND 4: The green band, 0.5 to 0.6 micrometers, emphasizes movement of sediment-laden water and delineates areas of shallow water, such as shoals, reefs, etc., useful in differentiating lithology;</p>	<p>U.S. Geological Survey (USGS); National Information Center (NCIC), Reston, VA, U.S. Soil Conservation Service (SCS); U.S. Forest Service; U.S. Bureau of Land Management; Tennessee Valley Authority.</p>
	<p>Imagery available in scales of 1:1,000,000; 1:400,000; and 1:250,000. 1978 prices ranged from \$8.00 for black and white images at 1:1,000,000 to \$50.00 for color infrared composite at 1:250,000.</p>	<p>From Earth Resources Observation System (EROS) Data Center, Sioux Falls, SD 57198. Closest regional source can be determined by calling (605) 594-6511, Ext. 151.</p>

TABLE 2 (continued)  
Remote Sensing Data

TYPE	DESCRIPTION AND GENERAL USE	AVAILABILITY
	<p>BAND 6: The red band, 0.6 to 0.7 micrometers, emphasizes cultural features, such as metropolitan areas;</p> <p>BAND 7: The near-infrared band, 0.7 to 0.8 micrometers, emphasizes vegetation, the boundary between land and water, landforms and useful in structural interpretation of geology;</p> <p>BAND 8: The second near-infrared band 0.8 to 1.1 micrometers, provides the best penetration of atmospheric haze, the best band for detecting faults, lineaments, mega-joint patterns or other structural features, and also emphasizes vegetation, the boundary between land and water, and landforms.</p>	
Skylab	<p>Satellite orbit 270 miles above earth with system which includes a six lens multi-spectra camera and an Earth terrain camera. Six lens array designed to provide high-quality photography of Earth's surface. Films used were filtered black and white, color and false color infrared. Area covered by</p>	<p>From EROS Data Center, Sioux Falls, SD 47198. Photos can be enlarged to scale of 1:250,000 with almost no loss of information.</p>

TABLE 2 (continued)  
Remote Sensing Data

TYPE	DESCRIPTION AND GENERAL USE	AVAILABILITY
Skylab (cont'd)	<p>each image is 100 x 100 miles. The Earth terrain camera provided high resolution photography for scientific study. Various black and white, color and false-color infrared films used. Each frame covers 70 x 70 miles. Limited data were acquired between latitudes 40 degrees north and 50 degrees south in 1973-74 flights. Skylab flights are completed. Photography is useful for regional planning, environmental studies, and geologic analyses.</p>	
NASA	<p>Aerial photography produced from NASA Earth Resources Aircraft Program. Photos available in wide variety of formats from flights as low as a few thousand feet to U-2 flights at altitudes above 60,000 feet. High altitude photos generally available at scales of about 1:120,000 and 1:60,000. At 1:120,000 scale area covered is about 17 miles on a side. Photos available in black and white, color, or false-color infrared. Coverage not available for all areas. Flights provide good resolution photos for planning, environmental studies or site oriented studies; color IR excellent for fault/lineament evaluation.</p>	<p>Purchase from EROS Data Center, Sioux Falls, SD 57198. Prices in 1978 range upward from \$8.00 for 1:120,000 scale black and white photos.</p>

TABLE 2 (continued)  
Remote Sensing Data

TYPE	DESCRIPTION AND GENERAL USE	AVAILABILITY
SLAR	<p>Side-looking airborne radar (SLAR) is especially applicable in areas of persistent cloud cover and can be essentially obtained in all-weather, day-night operations. Radar uses low, oblique illumination angles giving appearance of low sun angle imagery. It gives large area views of Earth's surface being available in scales ranging from 1:2,000,000 to 1:250,000. SLAR should not be used to replace air photos; it is a valuable complement to photos for regional studies. This is the best imagery for regional structural (faults/lineaments) analysis, often increasing detection of lineaments by 100-200%.</p>	<p>National Cartographic Information Center (NCIC), Reston, VA.; Goodyear Aerospace Corporation and Motorola, Litchfield Park, AZ.; Westinghouse Electric Corp., Philadelphia, PA.</p>
Thermal IR	<p>Thermal infrared sensors detect the different intensity of infrared emission (or heat) from an object or the Earth surface. Where temperature contrasts are significant, thermal IR imagery can be useful. Ordinarily it is used for special purposes or projects and could be useful as a complement to other remote sensing data during a planning and siting study. Useful in fault detection in covered alluvial areas, geothermal exploration, location of seepage, location of near surface peat deposits, covered meander scars, and heat loss studies.</p>	<p>Very little of Earth's surface covered. Mostly obtained as needed; most aerial survey firms have capability of flying thermal IR at prices comparable to large scale photographic coverage. A recent satellite, Heat Capacity Mapping Mission (HCMM) has been acquiring thermal IR data over the U.S. and portions of foreign countries. Hard copy images to eventually be available through National Space Science Data Center, Goddard Space Flight Center, Greenbelt, MD. No cost data available.</p>

a. Flight strips. Most aerial photographs are taken as flight strips with 60 percent or more overlap between pictures along the flight line and 20 to 30 percent side overlap between parallel flight lines.

b. Interpretation. When overlapping pictures are viewed stereoscopically, ground relief appears. From the appearance of land forms or erosional or depositional features, the character of soil or rock may be interpreted (see Reference 3, Terrain Analysis, A Guide to Site Selection Using Aerial Photographic Interpretation, by Way, for guidance on interpretation and terrain analysis with respect to issues in site development).

3. LIMITATIONS. Interpretation of aerial photographs and other remote sensed data requires considerable experience and skill, and results obtained depend on the interpreter's proficiency. Spot checking in the field is an essential element in photo-geologic interpretation.

a. Accuracy. Accuracy is limited where dense vegetation obscures ground features (unless SLAR imagery is used) and is dependent upon the scale, sensors, film products and enlargements. Recently, computer enhancements of multi-spectral imagery has made LANDSAT data compatible with conventional aerial photography.

b. Utility. For intensive investigations within developed areas, aerial photographs are not essential to exploration. Although valuable, the technique does not provide quantitative information for site specific foundation conditions. However, photo-interpretation greatly aids qualitative correlation between areas of known and unknown subsurface conditions.

#### Section 4. GEOPHYSICAL METHODS

1. UTILIZATION. See Table 3 for onshore and Table 4 for offshore geophysical methods and application.

a. Advantages. In contrast to borings, geophysical surveys explore large areas rapidly and economically. They indicate average conditions along an alignment or in an area rather than along the restricted vertical line at a single location as in a boring. This helps detect irregularities of bedrock surface and interface between strata.

b. Applications. Geophysical methods are best suited to prospecting sites for dams, reservoirs, tunnels, highways, and large groups of structures, either on or offshore. They also have been used to locate gravel deposits and sources of other construction materials where properties differ substantially from adjacent soils. Downhole, uphole and cross-hole seismic surveys are used extensively for determining dynamic properties of soil and rock at small strains.

(1) Rippability-velocity relationships for various rock types are given in DM-7.2 Chapter 1.

TABLE 2  
Remote Sensing Data

TYPE	DESCRIPTION AND GENERAL USE	AVAILABILITY
Aerial Photography	<p>Available in 9-inch frames with overlap for stereoscopic viewing. Valuable because of high resolution and available scales could range from 1:12,000 (or larger) to 1:80,000. Photos used extensively for topographic and/or geologic mapping, drainage patterns, and other uses include identifying location of existing structures, vegetation, access routes and site locations for planned explorations.</p> <p>Imagery obtained by satellite which flies in circular orbit 570 miles above Earth's surface and circles Earth about 14 times a day. Gives repetitive coverage every 18 days. The primary sensor is the multispectral scanner (MSS) which acquires images 115 miles per side in four spectral bands. The four bands are:</p> <p>BAND 4: The green band, 0.5 to 0.6 micrometers, emphasizes movement of sediment-laden water and delineates areas of shallow water, such as shoals, reefs, etc., useful in differentiating lithology;</p>	<p>U.S. Geological Survey (USGS); National Information Center (NCIC), Reston, VA, U.S. Soil Conservation Service (SCS); U.S. Forest Service; U.S. Bureau of Land Management; Tennessee Valley Authority.</p> <p>From Earth Resources Observation System (EROS) Data Center, Sioux Falls, SD 57198. Closest regional source can be determined by calling (605) 594-6511, Ext. 151.</p> <p>Imagery available in scales of 1:1,000,000; 1:400,000; and 1:250,000. 1978 prices ranged from \$8.00 for black and white images at 1:1,000,000 to \$50.00 for color infrared composite at 1:250,000.</p>

TABLE 3 (continued)  
Onshore Geophysics for Engineering Purposes

Name of Method	Procedure or Principle Utilized	Applicability and Limitations
Uphole, Downhole and Cross-hole Surveys	<p>Uphole or downhole: Geophones on surface, energy source in borehole at various locations starting from hole bottom. Procedure can be revised with energy source on surface, detectors moved up or down the hole.</p> <p>Downhole: Energy source at the surface (e.g., wooden plank struck by hammer), geophone probe in borehole.</p> <p>Cross-hole: Energy source in central hole, detectors in surrounding holes.</p>	<p>Obtain dynamic soil properties at very small strains, rock mass quality, cavity detection. Unreliable for irregular strata or soft strata with large gravel content. Also unreliable for velocities decreasing with depth. Cross-hole measurements best suited for in situ modulus determination.</p>
ELECTRICAL METHODS Resistivity	<p>Based on the difference in electrical conductivity or resistivity of strata, depths is determined by measuring the potential drop and current flowing between two current and two potential electrodes from a battery source. Resistivity is correlated to material type.</p>	<p>Used to determine horizontal extent and depths up to 100 feet of subsurface strata. Principal applications for investigating foundations of dams and other large structures, particularly in exploring granular river channel deposits or bedrock surfaces. Also used for locating fresh/salt water boundaries.</p>
Drop In Potential	<p>Based on the determination of the ratio of potential drops between 3 potential electrodes as a function of the current imposed on 2 current electrodes.</p>	<p>Similar to resistivity methods but gives sharper indication of vertical or steeply inclined boundaries and more accurate depth determinations. More susceptible than resistivity method to surface interference and minor irregularities in surface soils.</p>



TABLE 3 (continued)  
Onshore Geophysics for Engineering Purposes

Name of Method	Procedure or Principle Utilized	Applicability and Limitations
E-Logs	Based on differences in resistivity and conductivity measured in borings as the probe is lowered or raised.	Useful in correlating units between borings, has been used to correlate materials having similar seismic velocities. Generally not suited to civil engineering exploration but valuable in geologic investigations.
MAGNETIC MEASUREMENTS	Highly sensitive proton magnetometer is used to measure the Earth's magnetic field at closely spaced stations along a traverse.	Difficult to interpret in quantitative terms but indicates the outline of faults, bedrock, buried utilities, or metallic trash in fills.
GRAVITY MEASUREMENTS	Based on differences in density of subsurface materials as indicated by the vertical intensity or the curvature and gravitational field at various points being investigated.	Useful in tracing boundaries of steeply inclined subsurface irregularities such as faults, intrusions, or domes. Methods not suitable for shallow depth determination but useful in regional studies. Some application in locating limestone caverns.

TABLE 4  
Offshore Geophysical Methods

Equipment	Purpose	Characteristics	Capabilities
<p><u>Depth Recorders:</u></p> <p>Fathometer</p>	<p>Precision depth recording determining bathymetry.</p>	<p>Most recording sounders operate 200 KHz, pipe mounted transducer. Little subbottom penetration.</p>	<p>Four depth ranges cover 0-250 feet; range doubling switch permits bottom tracking to 410 feet; accuracy of 0.5% of indicated depth.</p>
<p><u>Seismic Reflection Profilers:</u></p> <p>Stratasonde Acoustic Hypacs</p>	<p>Seismic profiling (shallow) - characteristics of surface materials.</p>	<p>Low-frequency SONAR-type transducer profiling system; operates at 3.5 and 7 KHz frequency; high resolution due to short pulse length and high repetition rate.</p>	<p>Resolve reflecting layers within 3-4 feet of the bottom; penetration capabilities of 50 feet or less.</p>
<p>Acoustipulse Boomer</p>	<p>Seismic profiling (intermediate) - characteristics of surface and subsurface materials.</p>	<p>Electromechanical transducer; short duration, high power electrical pulse discharges from an energy source into an electromagnetic coil controlled metal plate, generating a repeatable sound pulse; mounted in a catamaran sled towed by vessel; board band acoustic pulse in 500-800 Hz region.</p>	<p>Operates in water depth from 10-600 feet; provides moderate resolution with moderate penetration up to 300 feet or more for geologic and engineering investigation.</p>

TABLE 4 (continued)  
Offshore Geophysical Methods

Equipment	Purpose	Characteristics	Capabilities
Sparker	Seismic profiling (deep) - geologic structure of bedrock.	Low-frequency, high energy sound generated by rapid discharge of electrical energy between electrodes and a surrounding frame; a plasma bubble is formed in the frequency range of 100-500 Hz and energy discharges 100-3000 joules.	Operates in water depths of 40-2000 feet, resolution capabilities of 50-80 feet with penetration depths of hundreds to thousands of feet depending upon energy selection.
Side Scan Sonar	Bottom surface features.	Mark 1B; SONAR image of ocean bottom up to 500 meters on each side of tow fish; operates at 105 KHz frequency; new safety release harness allows recovery of tow fish when obstruction is encountered; acoustic reflectors, (rocks, metal objects, sand ripples) are shown by dark areas; depressions are shown by light areas.	High resolution scanning can differentiate various bottom materials, locate hazards or obstructions (submerged hulks, outcrops).

c. Criteria. No definite criteria for geophysical methods can be given because they are highly specialized and require experienced operators and interpreters for each application.

2. LIMITATIONS. Geophysical surveys are able to outline boundaries between strata, but can only indicate approximate soil properties.

a. Sources of Errors. Differences in degree of saturation, presence of mineral salts in groundwater, or similarities of strata that effect transmission of seismic waves may lead to vague or distorted conclusions.

b. Check Borings. Geophysical surveys should be supplemented by borings and sampling to determine soil properties and confirm the stratification revealed by the survey.

#### Section 5. SOIL BORINGS AND TEST PITS

1. SOIL BORINGS. Soil borings are probably the most common method of subsurface exploration in the field.

a. Boring Methods. See Table 5 for applicability of the several methods of making soil borings. For details of boring techniques and equipment, see Reference 4, Subsurface Exploration and Sampling for Civil Engineering Purposes, by Hvorslev.

b. Boring Layout. General guidance for preliminary and final boring layout is presented in Table 6 according to the type of structure or problem being investigated. Boring layout should also be governed by the geology of the site.

(1) Geological Sections. Arrange borings so that geological sections may be determined at the most useful orientations for final siting and design. Borings in slide areas should establish the full geological section necessary for stability analyses.

(2) Critical Strata. Where detailed settlement, stability, or seepage analyses are required, include a minimum of two borings to obtain undisturbed samples of critical strata. Provide sufficient preliminary sample borings to determine the most representative location for undisturbed sample borings.

c. Boring Depths. The depth to which borings should be made depends on the sizes and types of proposed structures (see Table 7). It is also controlled to a great degree by the characteristics and sequence of the subsurface materials encountered.

(1) Unsuitable Foundation Strata. Extend all borings through unsuitable foundation strata, such as unconsolidated fill; peat; highly organic materials; soft, fine-grained soils; and loose, coarse-grained soils to reach hard or compact materials of suitable bearing capacity.

TABLE 5  
Types of Test Borings

Boring Method	Procedure Utilized	Applicability
Auger boring	Hand or power operated augering with periodic removal of material. In some cases continuous auger may be used requiring only one withdrawal. Changes indicated by examination of material removed. Casing generally not used.	Ordinarily used for shallow explorations above water table in partly saturated sands and silts, and soft to stiff cohesive soils. May be used to clean out hole between drive samples. Very fast when power-driven. Large diameter bucket auger permits examination of hole. Hole collapses in soft soils and soils below groundwater table.
Hollow-stem flight auger	Power operated, hollow stem serves as a casing.	Access for sampling (disturbed or undisturbed) or coring through hollow stem. Should not be used with plug in granular soil. Not suitable for undisturbed sampling in sand and silt.
Wash-type boring for undisturbed or dry sample	Chopping, twisting, and jetting action of a light bit as circulating drilling fluid removes cuttings from holes. Changes indicated by rate of progress, action of rods, and examination of cuttings in drilling fluid. Casing used as required to prevent caving.	Used in sands, sand and gravel without boulders, and soft to hard cohesive soils. Most common method of subsoil exploration. Usually can be adapted for inaccessible locations, such as on water, in swamps, on slopes, or within buildings. Difficult to obtain undisturbed samples.
Rotary drilling	Power rotation of drilling bit as circulating fluid removes cutting from hole. Changes indicated by rate of progress, action of drilling tools, and examination of cutting in drilling fluid. Casing usually not required except near surface.	Applicable to all soils except those containing much large gravel, cobbles, and boulders. Difficult to determine changes accurately in some soils. Not practical in inaccessible locations because of heavy truck mounted equipment, but applications are increasing since it is usually most

TABLE 5 (continued)  
Types of Test Borings

Boring Method	Procedure Utilized	Applicability
Percussion drilling (Churn drilling)	Power chopping with limited amount of water at bottom of hole. Water becomes a slurry that is periodically removed with bailer or sand pump. Changes indicated by rate of progress, action of drilling tools, and composition of slurry removed. Casing required except in stable rock.	rapid method of advancing borehole. Soil samples and rock cores usually limited to 6 inches.  Not preferred for ordinary exploration or where undisturbed samples are required because of difficulty in determining strata changes, disturbance caused below chopping bit, difficulty of access, and usually higher cost. Sometimes used in combination with auger or wash borings for penetration of coarse gravel, boulders, and rock formations. Could be useful to probe cavities and weakness in rock by changes in drill rate.
Rock core drilling	Power rotation of a core barrel as circulating water removes ground-up material from hole. Water also acts as coolant for core barrel bit. Generally hole is cased to rock.	Used alone and in combination with boring types to drill weathered rocks, bedrock, and boulder formations.
Wire-line drilling	Rotary type drilling method where the coring device is an integral part of the drill rod string which also serves as a casing. Core samples obtained by removing inner barrel assembly from the core barrel portion of the drill rod. The inner barrel is released by a retriever lowered by a wire-line through drilling rod.	Efficient for deep hole coring over 100 feet on land and offshore coring and sampling.

TABLE 6  
Requirements for Boring Layout

+))))))))))))))))))0))			
* Areas for	*	Boring Layout	*
* Investigation	*		*
/))))))))))))))))))3))1			
* New site of wide extent.	*	Space preliminary borings 200 to 500 ft apart so that area between any four borings includes approximately 10% of total area. In detailed exploration, add borings to establish geological sections at the most useful orientations.	*
/))))))))))))))))))3))1			
* Development of site on soft compressible strata.	*	Space borings 100 to 200 ft at possible building locations. Add intermediate borings when building sites are determined.	*
/))))))))))))))))))3))1			
* Large structure with separate closely spaced footings.	*	Space borings approximately 50 ft in both directions, including borings at possible exterior foundation walls at machinery or elevator pits, and to establish geologic sections at the most useful orientations.	*
/))))))))))))))))))3))1			
* Low-load warehouse building of large defined area.	*	Minimum of four borings at corners plus intermediate borings at interior foundations sufficient to subsoil profile.	*
/))))))))))))))))))3))1			
* Isolated rigid foundation 2,500 to 10,000 sq ft in area.	*	Minimum of three borings around perimeter. Add interior borings depending on initial results.	*
/))))))))))))))))))3))1			
* Isolated rigid foundation, less than 2,500 sq ft in area.	*	Minimum of two borings at opposite corners. Add more for erratic conditions.	*
/))))))))))))))))))3))1			
* Major waterfront structures, such as dry docks.	*	If definite site is established, space borings generally not farther than 50 ft adding intermediate borings at critical locations, such as deep pump-well gate seat, tunnel, or culverts.	*
/))))))))))))))))))3))1			
* Long bulkhead or wharf wall.	*	Preliminary borings on line of wall at 200 ft spacing. Add intermediate borings to decrease spacing to 50 ft. Place certain intermediate borings inboard and outboard of wall line to determine materials in scour zone at toe and in active wedge behind wall.	*
/))))))))))))))))))3))1			
* Slope stability, deep cuts, high embankments.	*	Provide three to five borings on line in the critical direction to provide geological section for analysis. Number of geological sections depends on extent of stability problem. For an active slide, place at least one boring up slope of sliding area.	*
.))))))))))))))))))2))-			

TABLE 6 (continued)  
Requirements for Boring Layout

+)))))))))))))))))))0))	,
* Areas for	*
* Investigation	* Boring Layout
/)))))))))))))))))))3))1	
* Dams and water	* Space preliminary borings approximately 200 ft over
* retention	* foundation area. Decrease spacing on centerline to
* structures.	* 100 ft by intermediate borings. Include borings at
*	* location of cutoff, critical spots in abutment,
*	* spillway and outlet works.
.)))))))))))))))))))2))-	



TABLE 7  
Requirements for Boring Depths

Areas of Investigation	Boring Depth
Large structure with separate closely spaced footings.	Extend to depth where increase in vertical stress for combined foundations is less than 10% of effective overburden stress. Generally all borings should extend to no less than 30 ft below lowest part of foundation unless rock is encountered at shallower depth.
Isolated rigid foundations.	Extend to depth where vertical stress decreases to 10% of bearing pressure. Generally all borings should extend no less than 30 ft below lowest part of foundation unless rock is encountered at shallower depth.
Long bulkhead or wharf wall.	Extend to depth below dredge line between 3/4 and 1-1/2 times unbalanced height of wall. Where stratification indicates possible deep stability problem, selected borings should reach top of hard stratum.
Slope stability.	Extend to an elevation below active or potential failure surface and into hard stratum, or to a depth for which failure is unlikely because of geometry of cross section.
Deep cuts.	Extend to depth between 3/4 and 1 times base width of narrow cuts. Where cut is above groundwater in stable materials, depth of 4 to 8 ft below base may suffice. Where base is below groundwater, determine extent of pervious strata below base.
High embankments.	Extend to depth between 1/2 and 1-1/4 times horizontal length of side slope in relatively homogeneous foundation. Where soft strata are encountered, borings should reach hard materials.
Dams and water retention structures.	Extend to depth of 1/2 base width of earth dams or 1 to 1-1/2 times height of small concrete dams in relatively homogeneous foundations. Borings may terminate after penetration of 10 to 20 ft in hard and impervious stratum if continuity of this stratum is known from reconnaissance.

(2) Fine-Grained Strata. Extend borings in potentially compressible fine-grained strata of great thickness to a depth where stress from superposed load is 50 small that corresponding consolidation will not significantly influence surface settlement.

(3) Compact Soils. Where stiff or compact soils are encountered at shallow depths, extend boring(s) through this material to a depth where the presence of an underlying weaker stratum cannot affect stability or settlement.

(4) Bedrock Surface. If bedrock surface is encountered and general character and location of rock are known, extend one or two borings 5 feet into sound, unweathered rock. Where location and character of rock are unknown, or where boulders or irregularly weathered material are likely geologically, increase the number of borings penetrating into rock to bracket the area. In cavernous limestone areas, extend borings through strata suspected of containing solution channels.

(5) Check Borings. In unfamiliar areas, at least one boring should extend well below the zone necessary for apparent stability, to make sure no unusual conditions exist at greater depth.

d. Sealing Boreholes. Borings made in foundation areas that eventually will be excavated below groundwater, or where artesian pressures are encountered, must be plugged or grouted unless they are used for continuing water-level observations. In boreholes for groundwater observations, place casing in tight contact with walls of holes, or fill annular space with sand/gravel.

e. Cavernous Limestone. In limestone areas suspected of containing solution channels or cavities, each column location should be investigated. For smaller structures, locate boring or probe at each planned column location. For large structures and area investigation use indirect methods noted below, followed by borings or probes in final column locations, and on close centers (25 ft. under walls or heavily loaded areas). Aerial photographs have been used effectively by experienced geologists for detecting sinkholes and the progress of cavity development by comparing old to new photographs. Geophysical methods are used to detect anomalies in subsurface resistivity, gravity, magnetic field or seismic velocities and to correlate such anomalies with cavity presence (see Reference 5, The Use of Geophysical Methods in Engineering Geology, Part II, Electrical Resistivity, Magnetic and Gravity Methods, by Higginbottom, and Reference 6, Bedrock Verification Program for Davis Besse Nuclear Power Station, by Millet and Morehouse).

2. TEST PITS. Test pits are used to examine and sample soils in situ, to determine the depth to groundwater, and to determine the thickness of topsoil. They range from shallow manual or machine excavations to deep, sheeted, and braced pits. See Table 8 for types, uses, and limitations of test pits and trenches. Hand-cut samples are frequently necessary for highly sensitive, cohesive soils, brittle and weathered rock, and soil formation with honeycomb structure.

TABLE 8  
Use, Capabilities and Limitations of Test Pits and Trenches

Exploration Method	General Use	Capabilities	Limitations
Hand-Excavated Test Pits and Shafts	Bulk sampling, in situ testing, visual inspection.	Provides data in inaccessible areas, less mechanical disturbance of surrounding ground.	Expensive, time-consuming, limited to depths above groundwater level.
Backhoe Excavated Test Pits and Trenches	Bulk sampling, in situ testing, visual inspection, excavation rates, depth of bedrock and groundwater.	Fast, economical, generally less than 15 feet deep, can be up to 30 feet deep.	Equipment access, generally limited to depths above groundwater level, limited undisturbed sampling.
Drilled Shafts	Pre-excavation for piles and shafts, landslide investigations, drainage wells.	Fast, more economical than hand excavated, min. 30 inches dia., max. 6 feet dia.	Equipment access, difficult to obtain undisturbed samples, casing obscures visual inspection.
Dozer Cuts	Bedrock characteristics depth of bedrock and groundwater level, ripability, increase depth capability of backhoes, level area for other exploration equipment.	Relatively low cost, exposures for geologic mapping.	Exploration limited to depth above groundwater level.
Trenches for Fault Investigations	Evaluation of presence and activity of faulting and sometimes landslide features.	Definitive location of faulting, subsurface observation up to 30 feet.	Costly, time-consuming, requires shoring, only useful where dateable materials are present, depth limited to zone above groundwater level.

3. TEST TRENCHES. Test trenches are particularly useful for exploration in very heterogeneous deposits such as rubble fills, where borings are either meaningless or not feasible. They are also useful for detection of fault traces in seismicity investigations.

#### Section 6. SAMPLING

1. APPLICATION. Disturbed samples are primarily used for classification tests and must contain all of the constituents of the soil even though the structure is disturbed. Undisturbed samples are taken primarily for laboratory strength and compressibility tests and in those cases where the in-place properties of the soil must be studied. Many offshore samplers fall in a special category and are treated separately in this section.

2. GENERAL REQUIREMENTS FOR SAMPLING PROGRAM. The number and type of samples to be taken depend on the stratification and material encountered.

a. Representative Disturbed Samples. Take representative disturbed samples at vertical intervals of no less than 5 feet and at every change in strata. Table 9 lists common types of samples for recovery of representative disturbed soil samples. Recommended procedures for obtaining disturbed samples are contained in ASTM Standard D1586, Penetration Test and Split Barrel Sampling of Soils.

b. Undisturbed Samples. The number and spacing of undisturbed samples depend on the anticipated design problems and the necessary testing program.

Undisturbed samples should comply with the following criteria: they should contain no visible distortion of strata, or opening or softening of materials; specific recovery ratio (length of undisturbed sample recovered divided by length of sampling push) should exceed 95 percent; and they should be taken with a sampler with an area ratio (annular cross-sectional area of sampling tube divided by full area of outside diameter of sampler) less than 15 percent. Table 10 lists common types of samplers used for recovery of representative undisturbed samples.

Obtain undisturbed samples in cohesive soil strata, so that there is at least one representative sample in each boring for each 10 feet depth. Recommended procedures for obtaining undisturbed samples are described in ASTM Standard D1587, Thin-Walled Tube Sampling of Soils. Additional cautions include the following:

(1) Caving. Use casing or viscous drilling fluid to advance borehole if there is danger of caving. If groundwater measurements are planned, drilling fluid should be of the revert type.

(2) Above Groundwater Table. When sampling above groundwater table, maintain borehole dry whenever possible.

TABLE 9  
Common Samplers for Disturbed Soil Samples and Rock Cores

Sampler	Dimensions	Best Results in Soil or Rock Types	Methods of Penetration	Causes of Disturbance or Low Recovery	Remarks
Split Barrel	2" OD - 1.375" ID is standard. Penetrometer sizes up to 4" OD - 3.5" ID available.	All fine-grained soils in which sampler can be driven. Gravels invalidate drive data.	Hammer driven	Vibration	SPT is made using standard penetrometer with 140# hammer falling 30". Undisturbed samples often taken with liners. Some sample disturbance is likely.
Retractable Plug	1" OD tubes 6" long. Maximum of 6 tubes can be filled in single penetration.	For silts, clays, fine and loose sands.	Hammer driven	Improper soil types for sampler. Vibration.	Light weight, highly portable units can be hand carried to job. Sample disturbance is likely.
Augers: Continuous Helical Flight	3" to 16" dia. Can penetrate to depths in excess of 50 feet.	For most soils above water table. Will not penetrate hard soils or those containing cobbles or boulders.	Rotation	Hard soils, cobbles, boulders.	Rapid method of determining soil profile. Bag samples can be obtained. Log and sample depths must account for lag between penetration of bit and arrival of sample at surface.

TABLE 9 (continued)  
Common Samplers for Disturbed Soil Samples and Rock Cores

Sampler	Dimensions	Best Results in Soil or Rock Types	Methods of Penetration	Causes of Disturbance or Low Recovery	Remarks
Disc	Up to 42" dia. Usually has maximum penetration of 25 feet.	Same as flight auger.	Rotation	Same as flight auger.	Rapid method of determining soil profile. Bag samples can be obtained.
Bucket	Up to 48" dia. common. Larger available. With extensions, depths greater than 80 feet are possible.	For most soils above water table. Can dig harder soil than above types, and can penetrate soils with cobbles and small boulders when equipped with a rock bucket.	Rotation	Soil too hard to dig.	Several type buckets available including those with ripper teeth and chopping buckets. Progress is slow when extensions are used.
Hollow Stem	Generally 6" to 8" OD with 3" to 4" ID hollow stem.	Same as Bucket.	Same	Same	A special type of flight auger with hollow center through which undisturbed samples or SPT can be taken.
Diamond Core Barrels	Standard sizes 1-1/2" to 3" OD, 7/8" to 2-1/8" core. See Figure 2. Barrel lengths 5 to 10 feet for exploration.	Hard rock. All barrels can be fitted with insert bits for coring soft rock or hard soil.			

TABLE 9 (continued)  
Common Samplers for Disturbed Soil Samples and Rock Cores

Sampler	Dimensions	Best Results in Soil or Rock Types	Methods of Penetration	Causes of Disturbance or Low Recovery	Remarks
Single Tube		Primarily for strong, sound and uniform rock.		Fractured rock. Rock too soft.	Drill fluid must circulate around core - rock must not be subject to erosion. Single tube not often used for exploration.
Double Tube		Non-uniform, fractured, friable and soft rock.		Improper rotation or feed rate in fractured or soft rock.	Has inner barrel or swivel which does not rotate with outer tube. For soft, erodible rock. Best with bottom discharge bit.
Triple Tube		Same as Double Tube.		Same as Double Tube.	Differs from Double Tube by having an additional inner split tube liner. Intensely fractured rock core best preserved in this barrel.

TABLE 10  
Common Samplers For Undisturbed Samples

Sampler	Dimensions	Best Results in soil types	Method of Penetration	Causes of Disturbance	Remarks
Shelby Tube	3" OD - 2.875" ID most common. Available from 2" to 5" OD. 30" sampler length is standard.	For cohesive fine-grained or soft soils. Gravelly soils will crimp the tube.	Pressing with fast, smooth stroke. Can be carefully hammered.	Erratic pressure applied during sampling, hammering, gravel particles, crimping tube edge, improper soil types for sampler.	Simplest sampler for undisturbed samples. Boring should be clean before lowering sampler. Little waste area in sampler. Not suitable for hard, dense or gravelly soils.
Stationary Piston	3" OD most common. Available from 2" to 5" OD. 30" sampler length is standard.	For soft to medium clays and fine silts. Not for sandy soils.	Pressing with continuous, steady stroke.	Erratic pressure during sampling, allowing piston rod to move during press. Improper soil types for sampler.	Piston at end of sampler prevents entry of fluid and contaminating material. Requires heavy drill rig with hydraulic drill head. Generally less disturbed samples than Shelby. Not suitable for hard, dense or gravelly soil. No positive control of specific recovery ratio.



TABLE 10 (continued)  
Common Samplers For Undisturbed Samples

Sampler	Dimensions	Best Results in soil types	Method of Penetration	Causes of Disturbance	Remarks
Hydraulic Piston (Osterberg)	3" OD most common - available from 2" to 4" OD, 36" sample length.	For silts-clays and some sandy soils.	Hydraulic or compressed air pressure.	Inadequate clamping of drill rods, erratic pressure.	Needs only standard drill rods. Requires adequate hydraulic or air capacity to activate sampler. Generally less disturbed samples than Shelby. Not suitable for hard, dense or gravelly soil. Not possible to limit length of push or amounts of sample penetration.
Denison	Samplers from 3.5" OD to 7-3/4" OD. (2.375" to 6.3" size samples). 24" sample length is standard.	Can be used for stiff to hard clay, silt and sands with some cementation, soft rock.	Rotation and hydraulic pressure.	Improperly operating sampler. Poor drilling procedures.	Inner tube face projects beyond outer tube which rotates. Amount of projection can be adjusted. Generally takes good samples. Not suitable for loose sands and soft clays.

TABLE 10 (continued)  
Common Samplers For Undisturbed Samples

Sampler	Dimensions	Best Results in soil types	Method of Penetration	Causes of Disturbance	Remarks
Pitcher Sampler	Sampler 4.125" OD uses 3" Shelby Tubes. 24" sample length.	Same as Denison.	Same as Denison.	Same as Denison.	Differs from Denison in that inner tube projection is spring controlled, Often ineffective in cohesionless soils.
Hand cut block or cylindrical sample	Sample cut by hand.	Highest quality undisturbed sampling in cohesive soils, cohesionless soil, residual soil, weathered rock, soft rock.		Change of state of stress by excavation.	Requires accessible excavation. Requires dewatering if sampling below groundwater.

(3) Below Groundwater Table. When sampling below groundwater table, maintain borehole full of water or drilling fluid during cleanout, during sampling and sample withdrawal, and while removing cleanout tools. Where continuous samples are required, casing should remain full for the entire drilling and sampling operation.

(4) Soft or Loose Soil. Sampling of a soft or loose soil directly below a stiff or compact soil in the same tube should be avoided. Discontinue driving of sample tube when a sudden decrease in resistance occurs.

3. UNDISTURBED SAMPLES FROM TEST PITS. Hand trimmed samples may be obtained in test pits, in test trenches, or in surface exposures. Samples so obtained are potentially the least disturbed of all types of samples. The basic procedure consists of trimming out a column of soil the same size or slightly smaller than the container to be used in transportation, sliding the container over the sample, and surrounding the sample with wax. Tight, stiff containers that can be sealed, and are not readily distorted, should be used.

4. ROCK CORES. Rock is sampled with core barrels having either tungstencarbide or diamond core bits as listed or described in Table 9 and Figure 2.

The suitability of cores for structural property tests depends on the quality of individual samples. Specify double or triple tube core barrel for maximum core recovery in weathered, soft, or fractured rock. The percentage of core recovery is an indication of soundness and degree of weathering of rock. Carefully examine core section for reasons for low recovery. More details on rock recovery can be found in Chapter 1.

5. SAMPLING OF DISINTEGRATED ROCK TRANSITION ZONES. General guidance on sampling of rock with various degrees of disintegration is given in Table 11 (modified from Reference 7, Sampling of Residual Soils in Hong Kong, by Brenner).

6. OFFSHORE SAMPLING. For water depths less than about 60 feet, land type soil boring equipment can be used on small jack-up platforms, small barges or barrel floats. Floating equipment requires suitable anchoring and is limited to fairly calm sea conditions. For deeper water or more extreme seas, larger drill ships are required to obtain quality undisturbed samples. See Table 12 for common underwater samplers. Numerous types of oceanographic samplers, both open-tube and piston types, are available for use from shipboard. These depend upon free-fall penetration and thus are limited in depth of exploration. The quality of samples obtained by most oceanographic samplers is not high because of their large length to diameter ratio. For detailed information on underwater sampling equipment see Reference 8, Underwater Soil Sampling, Testing and Construction Control, ASTM STP 501, and Reference 9, Seafloor Soil Sampling and Geotechnical Parameter Determination - Handbook, by Lee and Clausner.

Size Symbol		Casing, Core Barrel	Drill Rod	Casing OD	Casing Bit OD	Core Barrel Bit OD	Drill Rod OD	Approx. Diameter of Core Hole	Approx. Diameter of Core
EX	E			1 13/16	1 27/32	1 7/16	1 5/16	1 1/2	7/8
AX	A			2 1/4	2 5/16	1 27/32	1 5/8	1 7/8	1 1/8
BX	B			2 7/8	2 15/16	2 5/16	1 29/16	2 3/8	1 5/8
NX	N			3 1/2	3 9/16	2 15/16	2 3/8	3	2 1/8

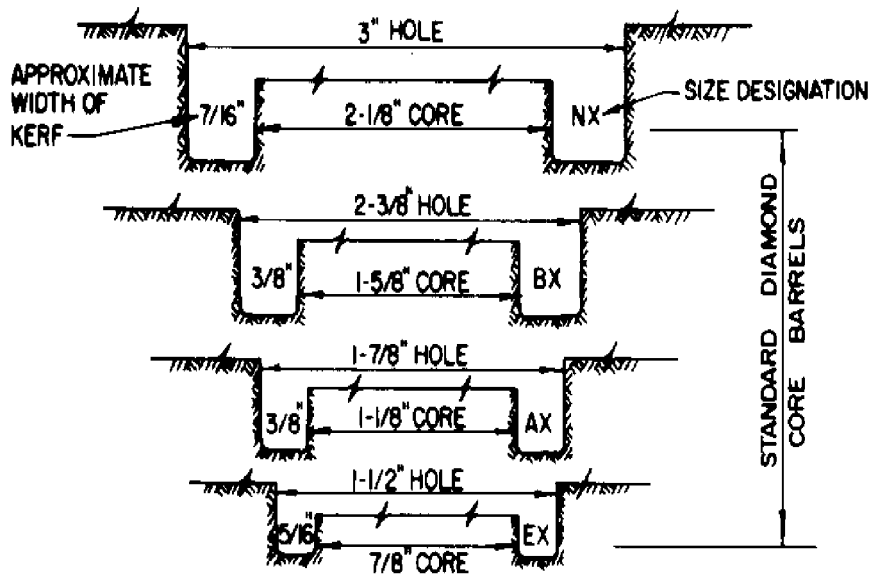

STANDARDS BY NATIONAL BUREAU OF STANDARDS DIAMOND CORE DRILL MANUFACTURERS.

FIGURE 2  
Standard Sizes, in Inches, for Casings, Rods, Core Barrels, and Holes

TABLE 11  
Sampling of Disintegrated Rock Zones

+))0))),	* Description of Material	* Sampling Method	*
/))3))1	* Colluvium - Loosely packed, poorly sorted material.	* Driven samples or triple tube core barrel. Double tube barrel is required for boulders. Denison Sampler can be used if no boulders are present.	*
/))3))1	* Structureless residual soil - The soil shows none of the fabric of the rock from which it is derived.	* Driven samples or triple tube core barrel. Dennison Sampler can be used. Hand cut samples are best.	*
/))3))1	* Decomposed rock containing rounded boulders which may be much harder than surrounding material.	* Driven samples or triple tube core barrel. Double tube barrel is required to sample boulders.	*
/))3))1	* Decomposed rock containing angular boulders separated by thin seams of friable material.	* Double tube core barrel with triple tube barrel in weak seams.	*
/))3))1	* Slightly decomposed rock - Friable material, if present, is limited to narrow seams.	* Double tube core barrel.	*
.))2))-			*

TABLE 12  
Common Underwater Samplers

Sampler	Size of Sample	Length of Sample	Water Depth Limitations	Method of Penetration	Remarks
Petersen Dredge	Grab	± 6" depth.	To 200' and more with additional weight.	Clam shell jaw.	Reliable grab sampler, intact samples may be obtained with jaws that precisely mate.
Open Barrel Gravity Corer	2.5" to 6" diameter	Core barrels length from 6' to 30'.	No limit on depth but required weight, amount of line or size of vessel may control.	Spooled freely off the winch drum.	
Phleger Corer	About 1.5" diameter	Core barrels available in 12", 24" and 36" length.	From 25' to 200'.	Free fall from 10' to 20' above bottom.	Relatively light-weight core for upper 1' to 3' of bottom sediments. Samples usually not suitable for strength tests.
Piston Gravity Corer	Standard corer has 2.5" barrel	Standard barrel is 10'. Additional 10' sections can be added.	No depth limit except that available weight, amount of line, or size of vessel may control.	Free fall from calibrated height above bottom such that piston does not penetrate sediments.	Capable of obtaining samples suitable for strength tests with experienced crew, but samples may be seriously disturbed.

TABLE 12 (continued)  
Common Underwater Samplers

Sampler	Size of Sample	Length of Sample	Water Depth Limitations	Method of Penetration	Remarks
Vibratory Corer	Sample is 3.5" diameter	20' standard, can be lengthened to 40'.	Minimum depth limited by draft of support vessel. Maximum depth about 200'.	Pneumatic impacting vibratory hammer.	Samples are disturbed because of vibration and large area ratio. Samples not suitable for strength testing. Penetration resistance can be measured, continuous representative samples in marine soils are obtained.

## Section 7. PENETRATION RESISTANCE TESTS

1. GENERAL. The most common test is the Standard Penetration Test (SPT) which measures resistance to the penetration of a standard sampler in borings. The method is rapid, and when tests are properly conducted in the field, they yield useful data, although there are many factors which can affect the results. A more controlled test is the cone penetrometer test in which a cone shaped tip is jacked from the surface of the ground to provide a continuous resistance record.

### a. Standard Penetration Test (SPT).

(1) Definition. The number of blows required to drive a split spoon sampler a distance of 12 inches after an initial penetration of 6 inches is referred to as an "N" value or SPT "N" value.

(2) Procedure. The test is covered under ASTM Standard D1586 which requires the use of a standard 2-inch (O.D.) split barrel sampler, driven by a 140 pound hammer dropping 30 inches in free fall. The procedure is generalized as follows:

(a) Clean the boring of all loose material, and material disturbed by drilling.

(b) Insert sampler, verifying the sampler reaches the same depth as was drilled.

(c) Obtain a consistent 30-inch free-fall drop of the hammer with two wraps of a rope around the cathead on the drill rig. (Cables attached to the hoisting drum should not be used because it is difficult to obtain free fall.)

(d) Drive the sampler 18 inches, or until normal maximum resistance (refusal) is reached, using the standard hammer and drop. (Refusal is defined as a penetration of less than 6 inches for 100 hammer blows.)

(e) Count and record the number of blows required to drive each 6 inches of penetration.

(3) Correlations. See Figure 1 and Table 4, Chapter 1 for approximate correlations between the "N" values from the standard penetration test and the compactness of granular soils and the consistency of fine grained soils.

(a) Relative Density of Granular (but fine grained) Deposits. Assuming that the test is a true standard test, the "N" value is influenced by the effective vertical stress at the level where "N" is measured, density of the soil, stress history, gradation and other factors. The work reported in Reference 10, SPT and Relative Density in Coarse Sands, by Marcuson and Bieganouski, establishes statistical relationships between relative density ( $D_r$ ,) in percent, "N" (blows/ft), effective vertical stress (pounds per square inch), gradation expressed in terms of uniformity coefficient ( $C_u$ ),



and overconsolidation ratio (OCR). The Gibbs & Holtz correlation of Figure 3 reported in Reference 11, Direct Determination and Indirect Evaluation of Relative Density and Earthwork Construction Projects, by Lacroix and Horn is commonly used to estimate the relative density from SPT.

(b) Undrained Shear Strength. A crude estimate for the undrained shear strength can be made using Figure 4. Correlations are not meaningful for medium to soft clays where effects of disturbance are excessive.

(c) Shear Modulus at Very Small Strains. A crude estimate of the shear modulus at small strains for sandy and cohesive soils can be obtained from the statistical relationships in Figure 5 (Reference 12, On Dynamic Shear Moduli and Poisson's Ratios of Soil Deposits, by Ohsaki and Iwasaki).

(d) Limitations. Except where confirmed by specific structural property tests, these relationships are suitable for estimates only. Blow counts are affected by operational procedures, by the presence of gravel, or cementation. They do not reflect fractures or slickensides in clay, which may be very important to strength characteristics. The standard penetration test results (N values) are influenced by operational procedures as illustrated in Table 13 (modified from Reference 13, Properties of Soil and Rock, by the Canadian Geotechnical Society).

b. Cone Penetrometer Tests (CPT). This test involves forcing a cone into the ground and measuring the rate of pressure needed for each increment of penetration. (See Figure 6). The most commonly used cone test is the Dutch Cone Test (DCT).

(1) Resistance. For the Dutch Cone, resistance to penetration is the sum of point resistance and frictional resistance on the sides of the shaft. The more sophisticated systems can differentiate between the point and frictional components of the resistance, and the ratio between frictional and point resistance (Friction Ratio) is one aid in differentiating between various soil types. Clean sands generally exhibit very low ratios (low friction component in comparison to point resistance), while an increase in clay content will usually result in a higher ratio, more often the result of a reduction in point resistance rather than an increase in frictional component.

(2) Correlations. Correlations have been developed for the cone penetration test with bearing capacity, relative density of sands, strength and sensitivity of clays and overconsolidation, as well as with SPT values and pile design parameters. Procedures and limitations of the cone penetration test and its correlations are described in Reference 14, Guidelines for Cone Penetration Tests Performance and Design, Federal Highway Administration.

(3) Advantages and Limitations. The static cone test can be used as a partial replacement for conventional borings. The speed of operation allows considerable data to be obtained in a short period of time. The major drawbacks of static cone tests are the non-recoverability of samples for identification, difficulty in advancing the cone in dense or hard deposits, and need for stable and fairly strong working surface to jack the rig against.

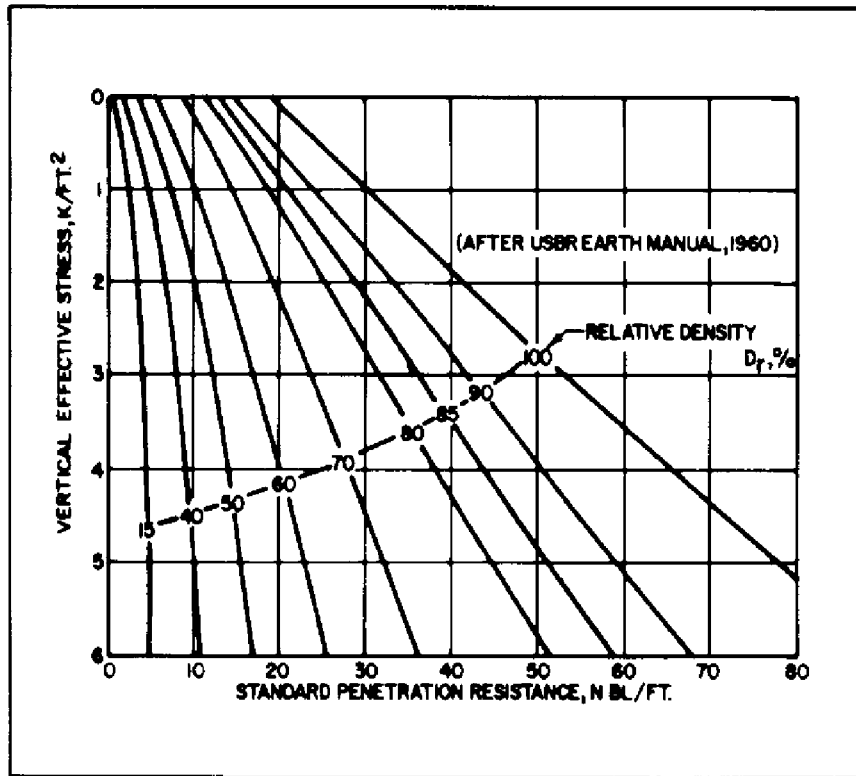

FIGURE 3  
 Correlations Between Relative Density and Standard Penetration  
 Resistance in Accordance with Gibbs and Holtz

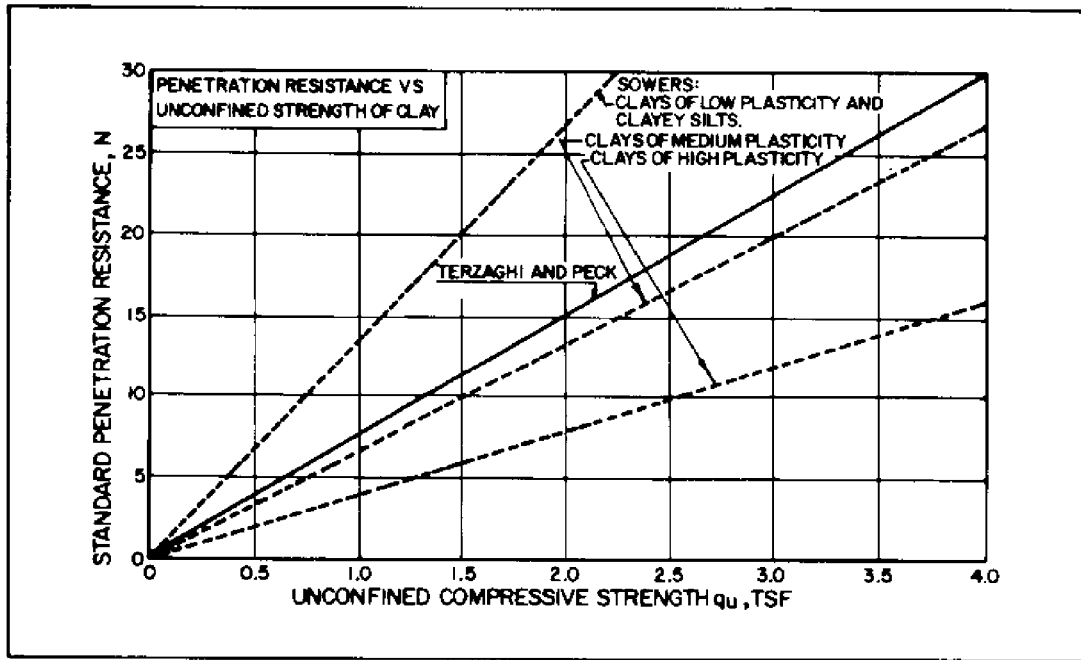

FIGURE 4  
Correlations of Standard Penetration Resistance

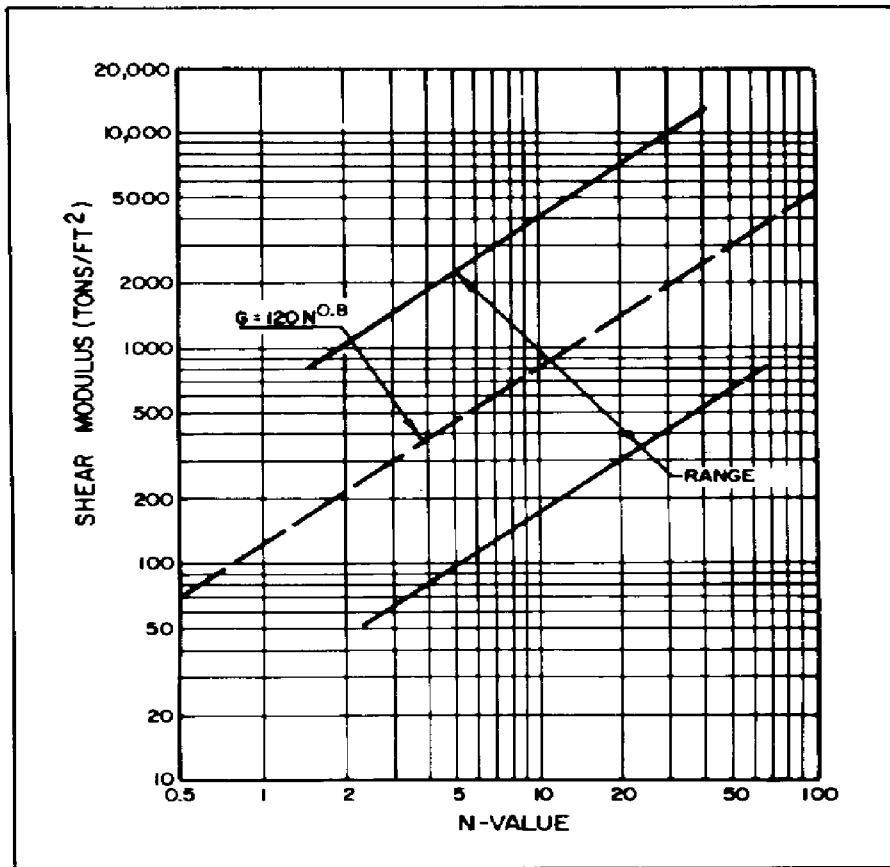

FIGURE 5  
Shear Modulus vs. N Values (SPT) at Very Small Strains

TABLE 13  
 Procedures Which May Affect the Measured "N" Values

+))))))))))))))))))0))			
* Inadequate	* SPT is only partially made in original soil.	*	*
* cleaning of	* Sludge may be trapped in the sampler and compressed	*	*
* the borehole	* as the sampler is driven, increasing the blow count.	*	*
*	* (This may also prevent sample recovery.)	*	*
*	*	*	*
* Not seating the	* Incorrect "N" values obtained.	*	*
* sampler spoon	*	*	*
* on undisturbed	*	*	*
* material	*	*	*
*	*	*	*
* Driving of	* "N" values are increased in sands and reduced in	*	*
* the sample	* cohesive soils.	*	*
* spoon above	*	*	*
* the bottom of	*	*	*
* the casing	*	*	*
*	*	*	*
* Failure to main-	* The water table in the borehole must be at least	*	*
* tain sufficient	* equal to the piezometric level in the sand, otherwise	*	*
* hydrostatic	* the sand at the bottom of the borehole may be	*	*
* head in boring	* transformed into a loose state.	*	*
*	*	*	*
* Attitude of	* Blow counts for the same soil using the same rig can	*	*
* operators	* vary, depending on who is operating the rig, and	*	*
*	* perhaps the mood of operator and time of drilling.	*	*
*	*	*	*
* Overdrive sampler	* Higher blow counts usually result from overdriven	*	*
* sampler	* sampler.	*	*
*	*	*	*
* Sampler plugged	* Higher blow counts result when gravel plugs sampler,	*	*
* by gravel	* resistance of loose sand could be highly overestimated.	*	*
*	*	*	*
* Plugged casing	* High "N" values may be recorded for loose sand when	*	*
*	* sampling below groundwater table. Hydrostatic	*	*
*	* pressure causes sand to rise and plug casing.	*	*
*	*	*	*
* Overwashing ahead	* Low blow count may result for dense sand since sand	*	*
* of casing	* is loosened by overwashing.	*	*
*	*	*	*
* Drilling method	* Drilling technique (e.g., cased holes vs. mud	*	*
*	* stabilized holes) may result in different "N" values	*	*
*	* for the same soil.	*	*
*	*	*	*
* Not using the	* Energy delivered per blow is not uniform. European	*	*
* standard	* countries have adopted an automatic trip hammer not	*	*
* hammer drop	* currently in use in North America.	*	*
*	*	*	*
* Free fall of the	* Using more than 1-1/2 turns of rope around the drum	*	*
* drive weight is	* and/or using wire cable will restrict the fall of	*	*
* not attained	* the drive weight.	*	*
.))))))))))))))))))2))-			



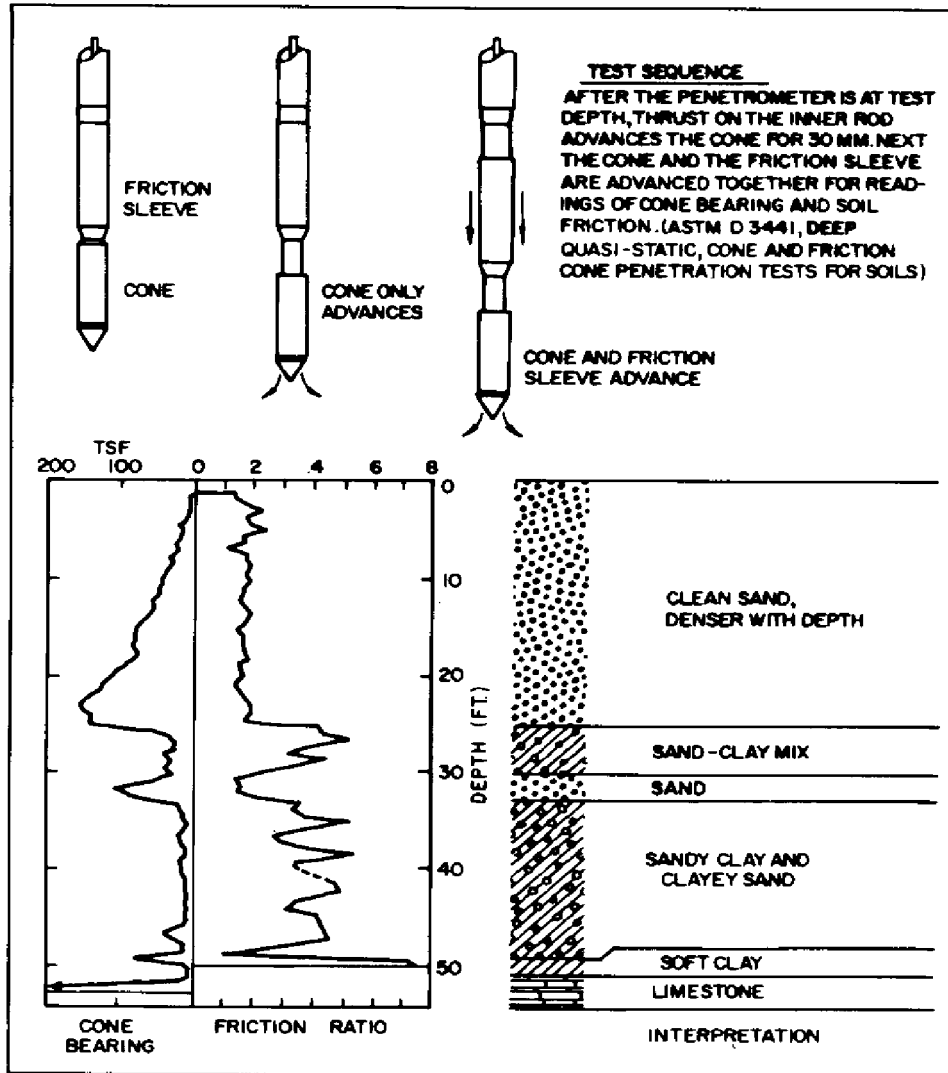

FIGURE 6  
 Dutch Cone Penetrometer

## Section 8. GROUNDWATER MEASUREMENTS

1. **UTILIZATION.** The groundwater level should be measured at the depth at which water is first encountered as well as at the level at which it stabilizes after drilling. If necessary, the boring should be kept open with perforated casing until stabilization occurs. On many projects, seasonal groundwater fluctuation is of importance and long-term measurements can be made by converting the borings to standpipe piezometers. For certain construction projects, more sophisticated pneumatic or electrical types of piezometers may be used.

2. **TYPICAL INSTALLATION.** The three basic components of a piezometer installation are:

a. **Tip.** A piezometer tip consisting of a perforated section, well screen, porous tube, or other similar feature and, in fine-grained or unstable materials, a surrounding zone of filter sand;

b. **Standpipe.** Watertight standpipe or measurement conduit, of the smallest practical diameter, attached to the tip and extending to the surface of the ground;

c. **Seals.** A seal or seals consisting of cement grout, bentonite slurry, or other similarly impermeable material placed between the standpipe and the boring walls to isolate the zone to be monitored.

The vertical location, i.e., depth and elevation of each item must be accurately measured and recorded.

3. **PIEZOMETER TYPES.** All systems, except the open well, have a porous filter element which is placed in the ground. The most common types used for groundwater measurements are described below (see Table 14).

a. **Open Well.** The most common groundwater recording technique is to measure water level in an open boring as shown in Figure 7(a). A disadvantage is that different layers of soil may be under different hydrostatic pressures and therefore the groundwater level recorded may be inaccurate and misleading. Thus, this system is useful only for relatively homogeneous deposits.

(1) **Open Standpipe Piezometer.** Most of the disadvantages of the open borehole can be overcome by installing an open standpipe piezometer in the borehole as shown in Figure 7(b). This system is effective in isolating substrata of interest.

b. **Porous Element Piezometer.** As shown in Figure 8, a porous element is connected to the riser pipe which is of small diameter to reduce the equalization time. The most common tip is the nonmetallic ceramic stone (Casagrande Type). The ceramic tip is subject to damage and for that reason porous metal tips or other tips of the same dimension are now available. Pores are about 50 microns size, so that the tip can be used in direct contact with fine-grained soils.



TABLE 14  
Groundwater or Piezometric Level Monitoring Devices

+)))))))))))))0)))))))))0)))))))))	* Instrument	* Advantages	* Disadvantages	*
/)))))))))))))3)))))))))3)))))))))1	* Standpipe piezometer * or wellpoint.	* Simple. Reliable. * Long experience * record. No elaborate * terminal point needed.	* Slow response time. * Freezing problems.	* *
/)))))))))))))3)))))))))3)))))))))1	* Pneumatic piezometer.	* Level of terminal * independent of tip * level. Rapid response.	* Must prevent humid air * from entering tubing.	* *
/)))))))))))))3)))))))))3)))))))))1	* Electric piezometer	* Level of terminal * independent of tip * level. Rapid response. * High sensitivity. * Suitable for automatic * readout.	* Expensive. Temperature * correction may be * required. Errors due to * zero drift can arise.	* * * *
.)))))))))))))2)))))))))2)))))))))-				

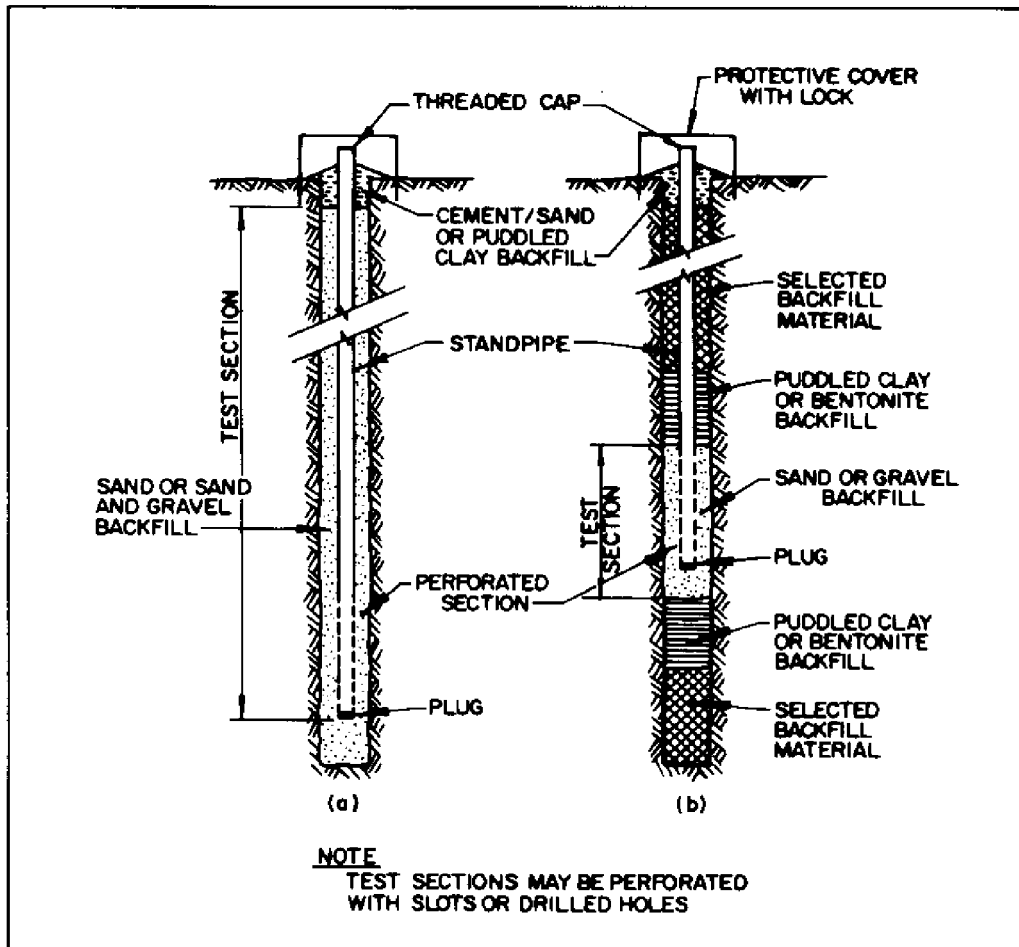

FIGURE 7  
 Open Standpipe Piezometers

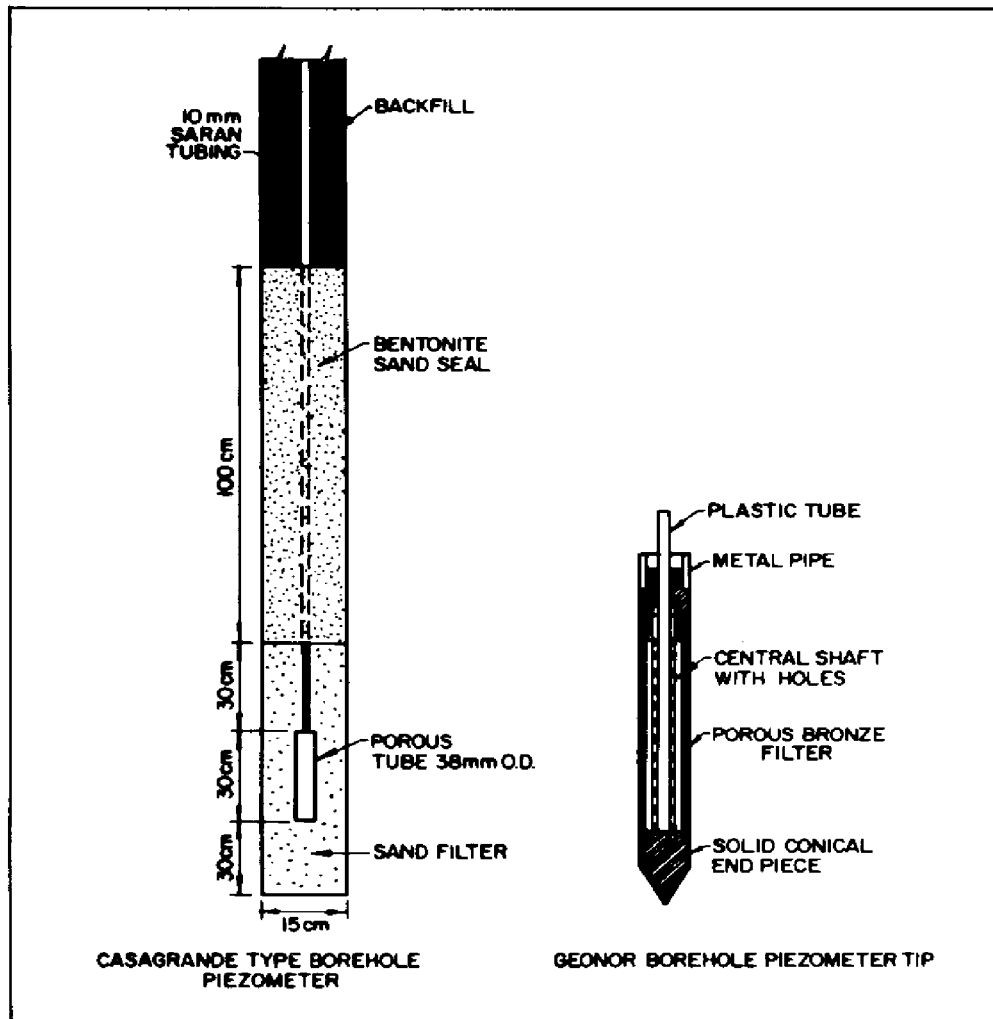

FIGURE 8  
Porous Element Piezometers

c. Other Types. Other piezometers used for special investigations include electrical, air pneumatic, oil pneumatic and water pressure types.

4. MULTIPLE INSTALLATIONS. Several piezometers may be installed in a single boring with an impervious seal separating the measuring zones. However, if measurements are needed in zones with 10 feet or less of vertical separation, it is generally best to install piezometers in separate borings.

5. MEASUREMENTS. water levels can be measured to within 0.5 inch, using several devices, including the plumb bob, cloth or metal surveyors' tapes coated with chalk, or commercially available electrical indicators for use in small tubes.

6. SOURCES OF ERROR. Major sources of error are due to gas bubbles and tube blockage. Some are shown in Figure 9. The magnitude of errors can be controlled by proper piezometer selection, installation, and de-airing techniques.

#### Section 9. MEASUREMENT OF SOIL AND ROCK PROPERTIES IN SITU

1. SCOPE. A great number of tools and methods have been devised for measuring in situ engineering properties of soil and rock. The most common tools, the split spoon sampler and the cone penetrometer, have been previously discussed. This section describes other methods commonly used in exploration programs or during construction control.

2. SHEAR STRENGTH BY DIRECT METHODS. Several devices are available to obtain shear strength data in the field as a supplement to laboratory tests or where it is not possible to obtain representative samples for testing.

a. Pocket Penetrometer. Used for obtaining the shear strength of cohesive, non-gravelly soils on field exploration or construction sites. Commercial penetrometers are available which read unconfined compressive strength directly. The tool is used as an aid to obtaining uniform classification of soils. It does not replace other field tests or laboratory tests.

b. Torvane Shear Device. Used for obtaining rapid approximations of shear strength of cohesive, non-gravelly soils on field exploration. Can be used on ends of Shelby tubes, penetration samples, block samples from test pits or sides of test pits. The device is used in uniform soils and does not replace laboratory tests.

c. Vane Shear Apparatus. Equipment setup for the vane shear test is illustrated in Figure 10 (Reference 15, Acker Soil Sampling Catalog, by Acker Drill Company, Inc.). In situ vane shear measurements are especially useful in very soft soil deposits where much of the strength may be lost by disturbance during sampling. It should not be used in stiff clays or in soft soils containing gravel, shells, wood, etc. The main equipment components are the torque assembly, which includes a gear reduction device capable of producing constant angular rotation of 1 degree to 6 degrees per minute, a calibrated proving ring with a dial gage for torque measurement within 5%, a means of

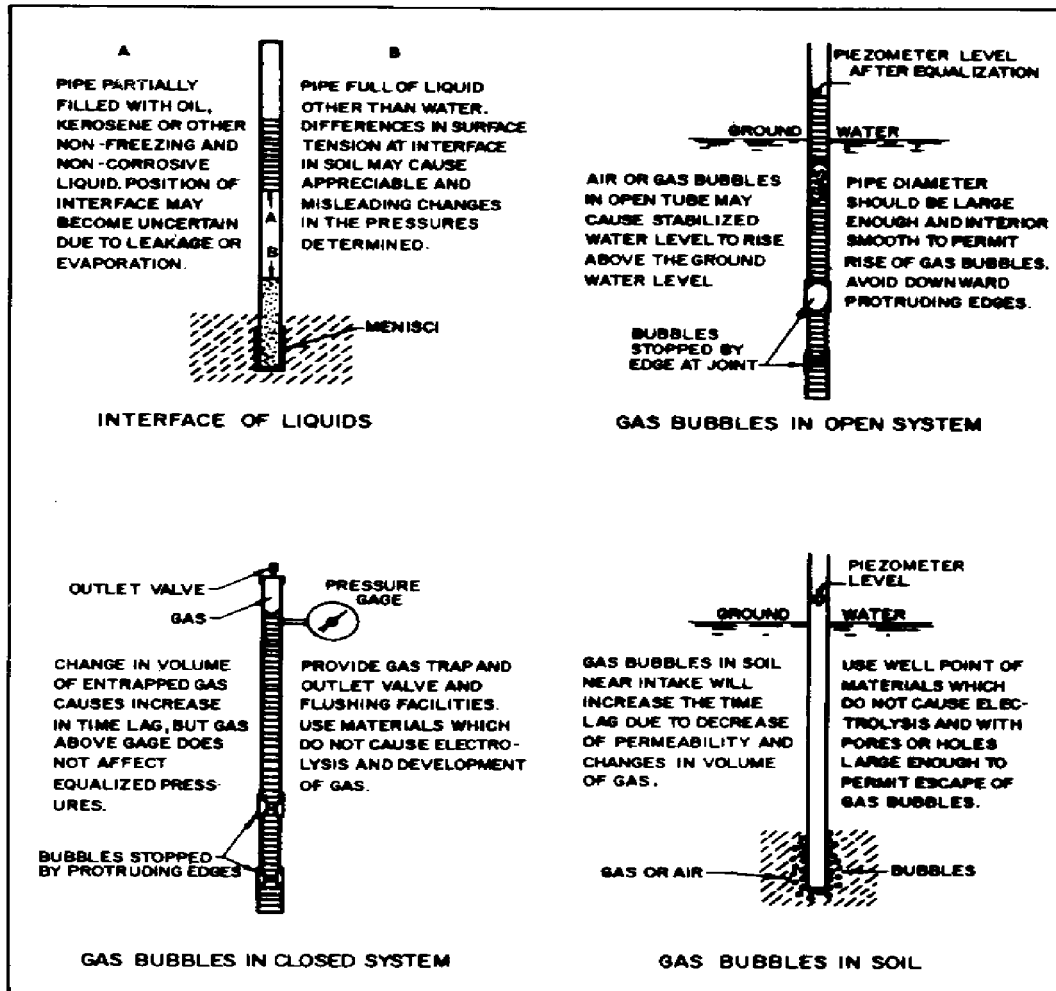

FIGURE 9  
Sources of Error and Corrective Methods in  
Groundwater Pressure Measurements

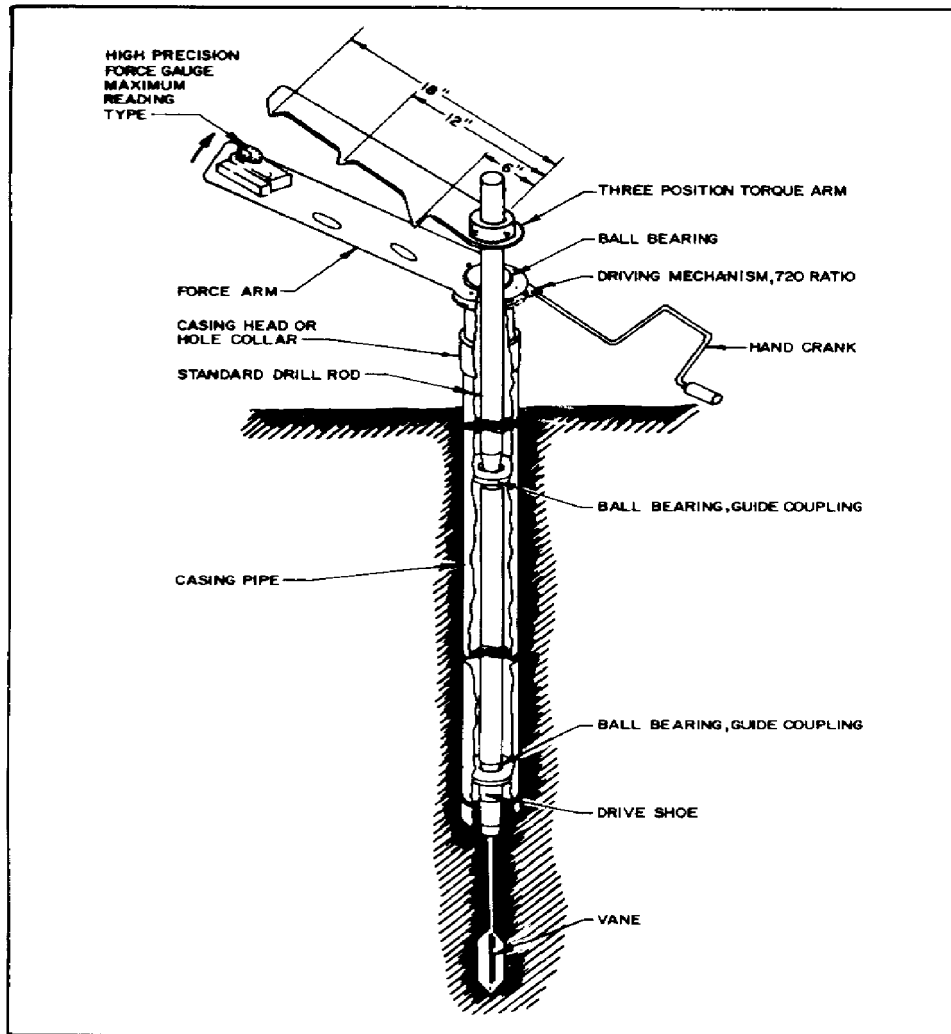

FIGURE 10  
Vane Shear Test Arrangement

measuring angular rotation in degrees, and thrust bearings to support vane at ground surface. Procedures for the vane shear test and methods of interpretation are described under ASTM Standard D2573, Field Vane Shear Test in Cohesive Soil.

3. DEFORMATION MODULI. A number of different methods are available for obtaining values of deformation moduli in soil and rock. Each method has its own advantages or disadvantages and in situ testing should only be attempted with a full knowledge of the limitations of the several techniques.

a. Pressuremeter. See Figure 11 (modified from Reference 13). The pressuremeter test is an in situ lateral loading test performed in a borehole by means of a cylindrical probe. Under increments of pressure, radial expansion is measured, and the modulus of deformation is calculated. If the test is carried to failure, shear strengths can be calculated and are generally higher than those obtained from vane shear tests. Materials difficult to sample (e.g., sands, residual soil, tills, soft rock) can be effectively investigated by the pressuremeter. Equipment and procedures for the pressuremeter are described in Reference 13.

(1) Limitations. Pressuremeter tests are sensitive to test procedures. The tests measure soil compressibility in the radial direction and some assumptions are required on the ratio between the vertical moduli to radial moduli. This may be difficult to interpret and thus of only limited value for stratified soils, for very soft soils, and for soils where drainage conditions during loading are not known. Roughness of the borehole wall affects test results, although the self-boring pressuremeter eliminates some of this disadvantage (see Reference 16, French Self-Boring Pressuremeter, by Baguelin and Jezequal, and Reference 17, Cambridge In-Situ Probe, by Wroth).

b. Plate Bearing Test. The plate bearing test can be used as an indicator of compressibility and as a supplement to other compressibility data.

(1) Procedure. For ordinary tests for foundation studies, use procedure of ASTM Standard D1194, Test for Bearing Capacity Of Soil for Static Load on Spread Footings, except that dial gages reading to 0.001 in. should be substituted. Tests are utilized to estimate the modulus of subgrade reaction and settlements of spread foundations. Results obtained have no relation to deep seated settlement from volume change under load of entire foundation.

(2) Analysis of Test Results. (See Figure 12.) Determine yield pressure for logarithmic plot of load versus settlement. Convert modulus of subgrade reaction determined from test  $K+vi$ , to the property  $K+v$ , for use in computing immediate settlement (Chapter 5). In general, tests should be conducted with groundwater saturation conditions simulating those anticipated under the actual structure.

Data from the plate load test is applicable to material only in the immediate zone (say to a depth of two plate diameters) of the plate and should not be extrapolated unless material at greater depth is essentially the same.

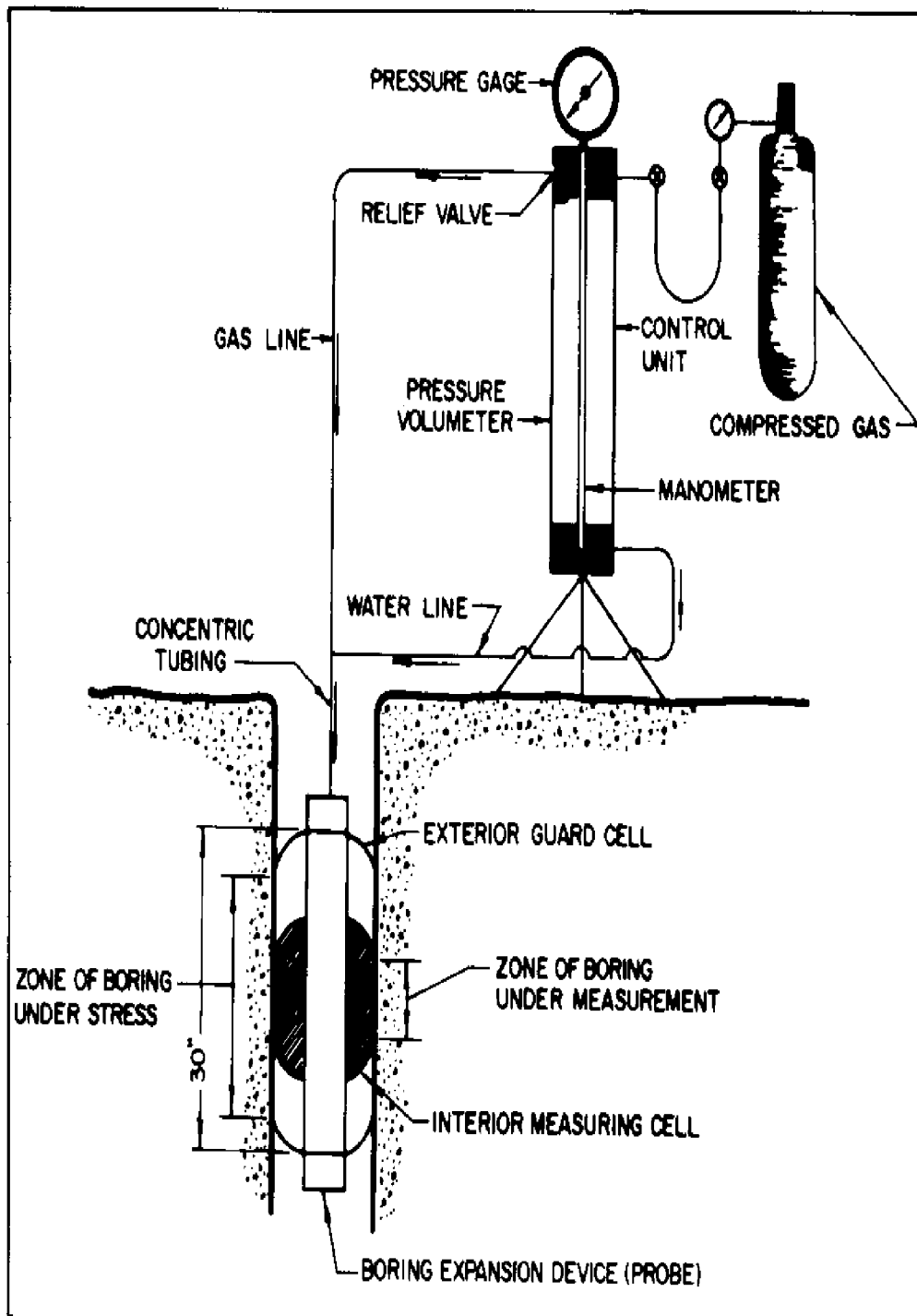

FIGURE 11  
Menard Pressuremeter Equipment



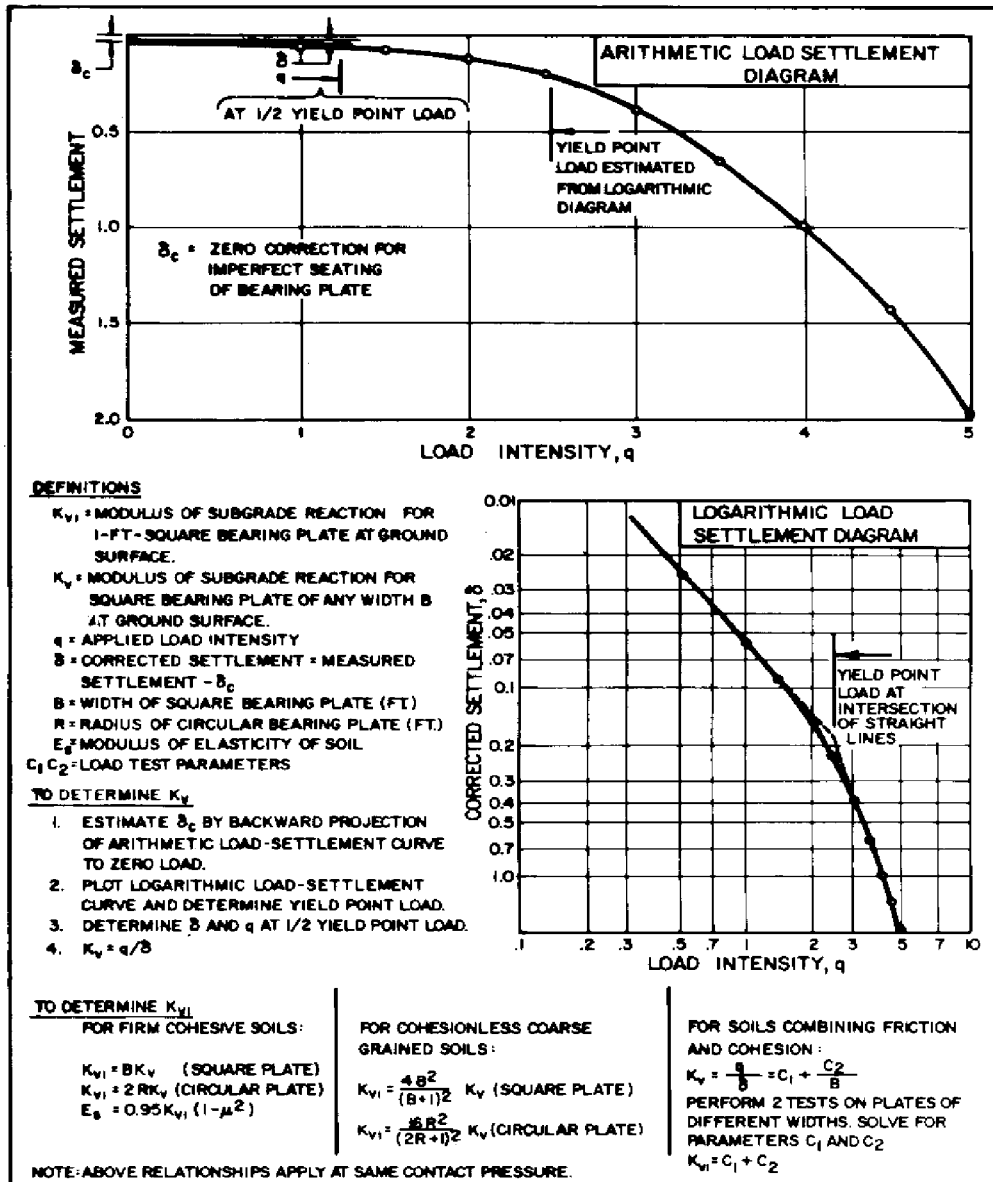

FIGURE 12  
Analysis of Plate Bearing Tests

4. PERMEABILITY. Field permeability tests measure the coefficient of permeability (hydraulic conductivity) of in-place materials. The coefficient of permeability is the factor of proportionality relating the rate of fluid discharge per unit of cross-sectional area to the hydraulic gradient (the pressure or "head" inducing flow, divided by the length of the flow path). This relation is usually expressed simply:

$$Q/A = \frac{HK}{L}$$

Where Q is discharge (volume/time); A is cross-sectional area, H/L is the hydraulic gradient (dimensionless); and K is the coefficient of permeability expressed in length per unit time (cm/sec, ft/day, etc.). The area and length factors are often combined in a "shape factor" or "conductivity coefficient." See Figure 13 for analysis of observations and Table 15 for methods of computation. Permeability is the most variable of all the material properties commonly used in geotechnical analysis. A permeability spread of ten or more orders of magnitude has been reported for a number of different types of tests and materials. Measurement of permeability is highly sensitive to both natural and test conditions. The difficulties inherent in field permeability testing require that great care be taken to minimize sources of error and to correctly interpret, and compensate for, deviations from ideal test conditions.

a. Factors Affecting Tests. The following five physical characteristics influence the performance and applicability of permeability tests:

- (1) position of the water level,
- (2) type of material - rock or soil,
- (3) depth of the test zone,
- (4) permeability of the test zone, and
- (5) heterogeneity and anisotropy of the test zone.

To account for these it is necessary to isolate the test zone. Methods for doing so are shown in Figure 14.

b. Types of Tests. Many types of field permeability tests can be performed. In geotechnical exploration, equilibrium tests are the most common. These include constant and variable head gravity tests and pressure (Packer) tests conducted in single borings. In a few geotechnical investigations, and commonly in water resource or environmental studies, non-equilibrium "aquifer" or "pump" tests are conducted (a well is pumped at a constant rate for an extended period of time). See Table 15 for computation of permeability from variable head tests.

(1) Constant Head Test. This is the most generally applicable permeability test. It may be difficult to perform in materials of either very high or very low permeability since the flow of water may be difficult to maintain or to measure.

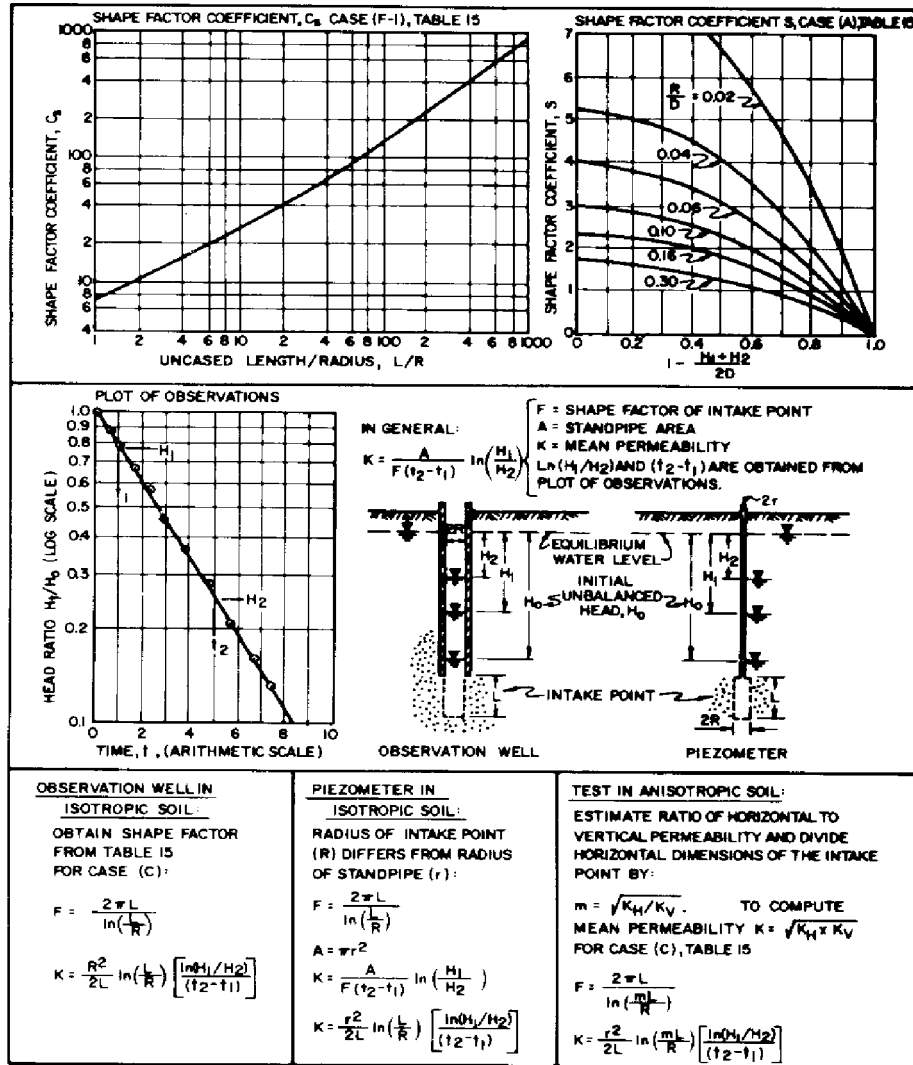
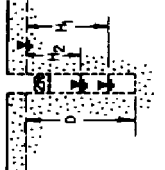
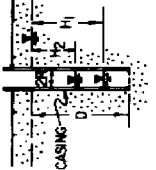
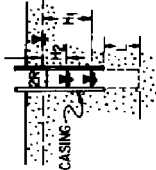
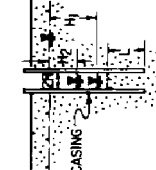

FIGURE 13  
 Analysis of Permeability by Variable Head Tests

TABLE 15  
Shape Factors for Computation of Permeability From Variable Head Tests

CONDITION	DIAGRAM	SHAPE FACTOR, F	PERMEABILITY, K BY VARIABLE HEAD TEST	APPLICABILITY
(A) UNCASD HOLE		$F = 16\pi DSR$	(FOR OBSERVATION WELL OF CONSTANT CROSS SECTION)  SIMPLEST METHOD FOR PERMEABILITY DETERMINATION. NOT APPLICABLE IN STRATIFIED SOILS. FOR VALUES OF S, SEE FIGURE 13.  $K = \frac{R}{16DS} \times \frac{(h_2 - h_1)}{(t_2 - t_1)}$ FOR $\frac{D}{R} < 50$	
(B) CASD HOLE, SOIL FLUSH WITH BOTTOM		$F = \frac{11R}{2}$	$K = \frac{2WR}{11(t_2 - t_1)} \ln \left( \frac{h_1}{h_2} \right)$ FOR $6'' \leq D \leq 60''$	USED FOR PERMEABILITY DETERMINATION AT SHALLOW DEPTHS BELOW THE WATER TABLE. MAY YIELD UNRELIABLE RESULTS IN FALLING HEAD TEST WITH SILTING OF BOTTOM OF HOLE.
(C) CASD HOLE, UNCASD OR PERFORATED EXTENSION OF LENGTH "L"		$F = \frac{2\pi L}{\ln \left( \frac{R}{r} \right)}$	$K = \frac{R^2}{2L(t_2 - t_1)} \ln \left( \frac{h_1}{h_2} \right) \ln \left( \frac{R}{r} \right)$ FOR $\frac{L}{R} > 8$	USED FOR PERMEABILITY DETERMINATIONS AT GREATER DEPTHS BELOW WATER TABLE.
(D) CASD HOLE, COLUMN OF SOIL INSIDE CASING TO HEIGHT "L"		$F = \frac{11\pi R^2}{2\pi R + 11L}$	$K = \frac{2\pi R + 11L}{11(t_2 - t_1)} \ln \left( \frac{h_1}{h_2} \right)$	PRINCIPAL USE IS FOR PERMEABILITY IN VERTICAL DIRECTION IN ANISOTROPIC SOILS.

OBSERVATION WELL OR PIEZOMETER IN SATURATED ISOTROPIC STRATUM OF INFINITE DEPTH

TABLE 15 (continued)  
Shape Factors for Computation of Permeability From Variable Head Tests

CONDITION	DIAGRAM	SHAPE FACTOR, F	PERMEABILITY, K BY VARIABLE HEAD TEST	APPLICABILITY
(E) CASSED HOLE, OPENING FLUSH WITH UPPER BOUNDARY OF AQUIFER OF INFINITE DEPTH.		$F = 4R$	(FOR OBSERVATION WELL OF CONSTANT CROSS SECTION) $K = \frac{\pi R}{4(l_2 - l_1)} \ln \left( \frac{H_1}{H_2} \right)$	USED FOR PERMEABILITY DETERMINATION WHEN SURFACE IMPERVIOUS LAYER IS RELATIVELY THIN. MAY YIELD UNRELIABLE RESULTS IN FALLING HEAD TEST WITH SILTING OF BOTTOM OF HOLE.
(F) CASSED HOLE, UNCASED OR PERFORATED EXTENSION INTO AQUIFER OF FINITE THICKNESS:		(1) $F = C_1 R$	$K = \frac{\pi R}{C_1(l_2 - l_1)} \ln \left( \frac{H_1}{H_2} \right)$	USED FOR PERMEABILITY DETERMINATIONS AT DEPTHS GREATER THAN ABOUT 5 FT. FOR VALUES OF $C_1$ , SEE FIGURE 13.
(1) $\frac{l_1}{L} \leq 0.2$		(2) $F = \frac{2\pi L_2}{\ln(L_2/R)}$	$K = \frac{R^2 \ln \left( \frac{L_2}{R} \right)}{2L_2(l_2 - l_1)} \ln \left( \frac{H_1}{H_2} \right)$ FOR $\frac{l_1}{R} = 18$	USED FOR PERMEABILITY DETERMINATIONS AT GREATER DEPTHS AND FOR FINE GRAINED SOILS USING POROUS INTAKE POINT OF PIEZOMETER.
(2) $0.2 < \frac{l_1}{L} < 0.85$		(3) $F = \frac{2\pi L_3}{\ln \left( \frac{R_0}{R} \right)}$	$K = \frac{R^2 \ln \left( \frac{R_0}{R} \right)}{2L_3(l_2 - l_1)} \ln \left( \frac{H_1}{H_2} \right)$	ASSUME VALUE OF $\frac{R_0}{R} = 200$ FOR ESTIMATES UNLESS OBSERVATION WELLS ARE MADE TO DETERMINE ACTUAL VALUE OF $R_0$ .
(3) $\frac{l_1}{L} = 1.00$				
NOTE: $R_0$ EQUALS EFFECTIVE RADIUS TO SOURCE AT CONSTANT HEAD.				
OBSERVATION WELL OR PIEZOMETER IN AQUIFER WITH IMPERVIOUS UPPER LAYER				

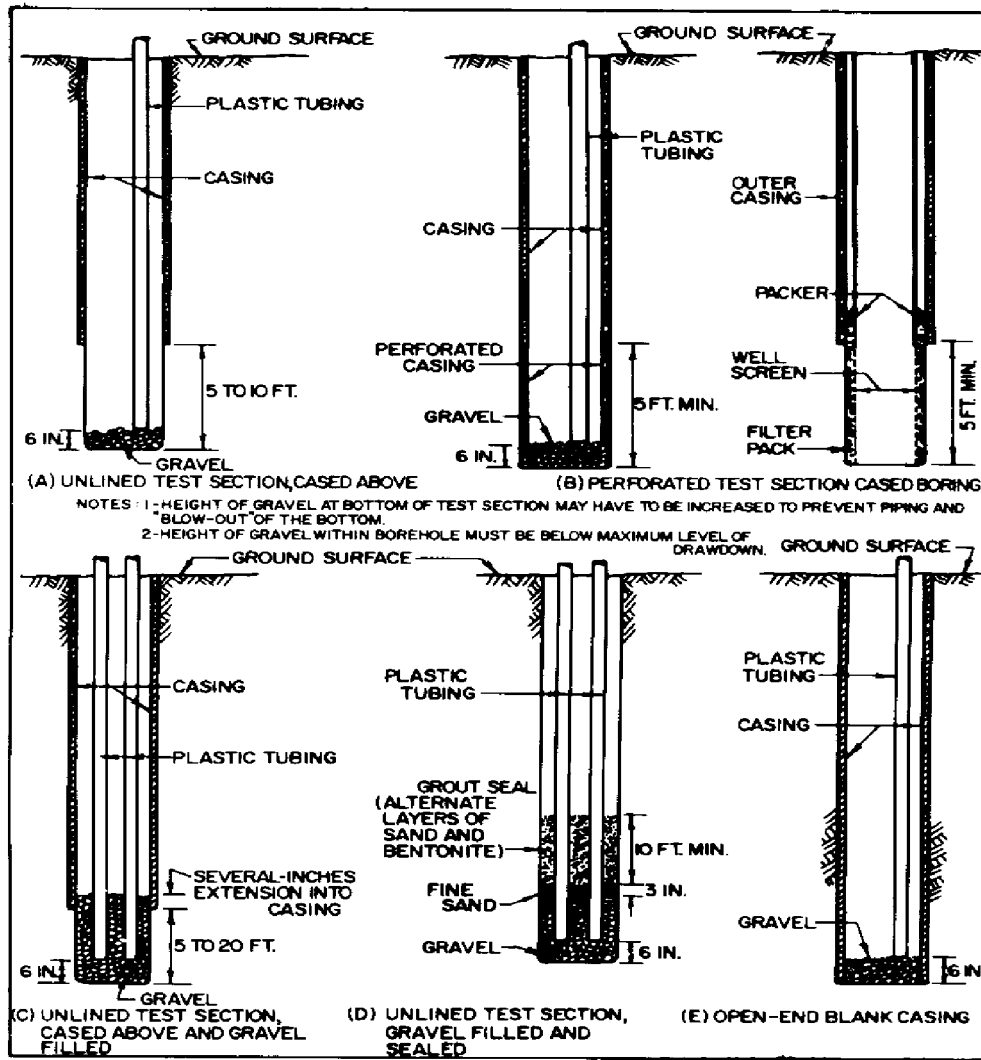

FIGURE 14  
 Test Zone Isolation Methods

(2) Rising Head Test. In a saturated zone with sufficiently permeable materials, this test is more accurate than a constant or a falling head test. Plugging of the pores by fines or by air bubbles is less apt to occur in a rising head test. In an unsaturated zone, the rising head test is inapplicable.

(3) Falling Head Test. In zones where the flow rates are very high or very low, this test may be more accurate than a constant head test. In an area of unknown permeability the constant head test should be attempted before a falling head test.

(4) Pumping Test. In large scale seepage investigations or groundwater resource studies, the expense of aquifer or pumping tests may be justified as they provide more useful data than any other type of test. Pump tests require a test well, pumping equipment, and lengthy test times. Observation wells are necessary. A vast number of interpretive techniques have been published for special conditions.

(5) Gravity and Pressure Tests. In a boring, gravity and pressure tests are appropriate. The segment of the boring tested is usually 5 to 10 feet, but may be larger. A large number of tests must be conducted to achieve an overall view of the seepage characteristics of the materials. The zone of influence of each test is small, usually a few feet or perhaps a few inches. These methods can detect changes in permeability over relatively short distances in a boring, which conventional pump or aquifer tests cannot. Exploration boring (as opposed to "well") methods are therefore useful in geotechnical investigations where inhomogeneity and anisotropy may be of critical importance. Results from pressure tests using packers in fractured rock may provide an indication of static heads, inflow capacities, and fracture deformation characteristics, but conventional interpretation methods do not give a true permeability in the sense that it is measured in porous media.

c. Percolation Test. The percolation test is used to ascertain the acceptability of a site for septic tank systems and assist in the design of subsurface disposal of residential waste. Generally, the length of time required for percolation test varies with differing soils. Test holes are often kept filled with water for at least four hours, preferably overnight, before the test is conducted. In soils that swell, the soaking period should be at least 24 hours to obtain valid test results.

(1) Type of Test. The percolation test method most commonly used, unless there are specified local requirements, is the test developed by the Robert A. Taft Sanitary Engineering Center as outlined in the Reference 18, Public Health Service Health Manual of Septic Tank Practice, by HUD. A specified hole is dug (generally 2 feet square), or drilled (4 inches minimum) to a depth of the proposed absorption trench, cleaned of loose debris, filled with coarse sand or fine gravel over the bottom 2 inches, and saturated for a specified time. The percolation rate measurement is obtained by filling the hole to a prescribed level (usually 6 inches) and then measuring the drop over a set time limit (usually 30 minutes). In sandy soils the time limit may be only 10 minutes. The percolation rate is used in estimating the required leaching field area as detailed in Reference 18.

5. IN-PLACE DENSITY. In-place soil density can be measured on the surface by displacement methods to obtain volume and weight, and by nuclear density meters. Density at depth can be measured only in certain soils by the drive cylinder (sampling tube) method.

a. Displacement Methods. Direct methods of measuring include sand displacement and water balloon methods. See Reference 19, Evaluation of Relative Density and its Role in Geotechnical Projects Involving Cohesionless Soils, ASTM STP 523. The sand displacement and water balloon methods are the most widely used methods because of their applicability to a wide range of material types and good performance. The sand displacement method (ASTM Standard D1556, Density of Soil in Place by the Sand Cone Method) is the most frequently used surface test and is the reference test for all other methods. A procedure for the water or rubber balloon method is given in ASTM Standard D2167, Density of Soil in Place by the Rubber Balloon Method.

b. Drive-Cylinder Method. The drive cylinder (ASTM Standard D2937, Density of Soil in Place by the Drive-Cylinder Method) is useful for obtaining subsurface samples from which the density can be ascertained, but it is limited to moist, cohesive soils containing little or no gravel and moist, fine sands that exhibit apparent cohesion.

c. Nuclear Moisture-Density Method. Use ASTM Standard D2922, Density of Soil and Soil-Aggregate in Place by Nuclear Methods (Shallow Depth). Before nuclear density methods are used on the job, results must be compared with density and water contents determined by displacement methods. Based on this comparison, corrections may be required to the factory calibration curves or a new calibration curve may have to be developed. Safety regulations pertaining to the use of nuclear gages are contained in Reference 20, Radiological Safety, U.S. Corps of Engineers ER 385-1-80.

6. DETECTION OF COMBUSTIBLE GASES. Methane and other combustible gases may be present in areas near sanitary landfills, or at sites near or over peat bogs, marshes and swamp deposits. Commercially available indicators are used to detect combustible gases or vapors and sample air in borings above the water table. The detector indicates the concentration of gases as a percentage of the lower explosive limit from 0 to 100 on the gage. The lower explosive limit represents the leanest mixture which will explode when ignited. The gage scale between 60% and 100% is colored red to indicate very dangerous concentrations. If concentrations are judged to be serious, all possibilities of spark generation (e.g., pile driving, especially mandrel driven shells) should be precluded, and a venting system or vented crawl space should be considered. The system could be constructed as follows:

(a) Place a 6-inch layer of crushed stone (3/4-inch size) below the floor slab; the crushed stone should be overlain by a polyethylene vapor barrier.

(b) Install 4-inch diameter perforated pipe in the stone layer below the slab; the top of the pipe should be immediately below the bottom of the slab.



(c) The pipes should be located such that gas rising vertically to the underside of the floor slab does not have to travel more than 25 feet laterally through the stone to reach a pipe.

(d) The pipes can be connected to a single, non-perforated pipe of 6-inch diameter, and vented to the atmosphere at roof level.

Further details on gas detection and venting can be found in References 21, Sanitary Landfill Design Handbook, by Noble, and 22, Process Design Manual, Municipal Sludge Landfills, by the EPA.

## Section 10. FIELD INSTRUMENTATION

1. UTILIZATION. Field instrumentation is used to measure load and displacement and to monitor changes during and after construction. This allows verification of design assumptions and performance monitoring, which could indicate the need for implementation of contingency plans or design changes. For additional guidance on planning and performing geotechnical monitoring see Reference 23, Geotechnical Instrumentation for Monitoring Field Performance, by Dunnycliff. See Reference 24, Equipment for Field Deformation Measurements, by Dunnycliff, for instrumentation devices in current use. See Figure 15 for an example of instrumentation adjacent to a building and diaphragm wall.

a. Survey Technique. The most common uses of optical survey techniques are for the determination of changes in elevation, or lateral displacement. The laser geodimeter provides a significant reduction in time as well as increased accuracy in monitoring of slopes. Survey techniques can be used effectively to monitor surface movement of building and adjacent ground movement of slopes and excavation walls. Figure 15 shows an application of optical surveys.

b. Monitoring of Settlement and Heave. Many devices are available for monitoring settlement and heave, including a number which will permit measurement of the compression of the separate soil layers. Vertical movement can also be measured by remote settlement gages utilizing closed fluid systems, and by extensometers embedded beneath foundations in an incompressible layer. These devices are also well suited to measuring heave. For a more detailed description of field instrumentation equipment see Reference 22, and the latest brochures of geotechnical instrumentation companies.

c. Horizontal and Slope Movements. In addition to conventional surveying techniques, horizontal movement can be measured by horizontal movement gauges, inclinometers, and extensometers. Inclinometers are especially useful for monitoring horizontal soil displacement along the vertical face of a cofferdam or bulkhead, or as in Figure 15, adjacent to an excavation. Tiltmeters can provide very precise measurements of slope changes in soil and rock formations or in structures.

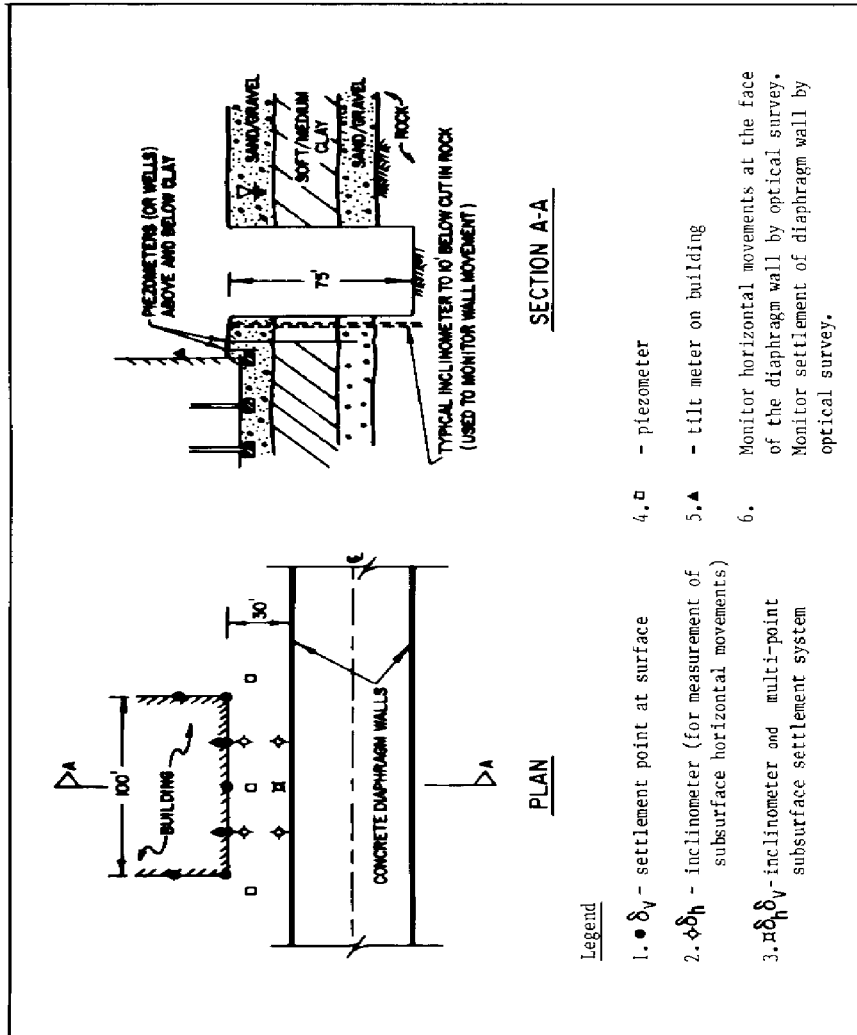

FIGURE 15  
Example of Instrumentation Adjacent to a Building and Diaphragm Wall

d. Loads and Temperature. See Table 16 (Reference 25, Lateral Support System and Underpinning, Volume II, Design Fundamentals, by Goldberg, et al.) for load and temperature monitoring devices commonly used in walled excavations.

TABLE 16  
Load and Temperature Devices in Walled Excavation Elements

Parameter	Instrument	Advantages	Limitations
Load and Stress in Struts, Soldier Piles, Sheet Piles, Wales and Diaphragm Walls.	Mechanical strain gage.	Inexpensive, simple. Easy to install. Minimum damage potential.	Access problems. Many temperature corrections required. Limited accuracy. Readings are subjective.
	Vibrating wire strain gage.	Remote readout. Readout can be automated. Potential for accuracy and reliability. Frequency signal permits data transmission over long distances. Gages can be re-used.	Expensive. Sensitive to temperature, construction damage. Requires substantial skill to install. Risk of zero drift. Risk of corrosion if not hermetically sealed.
	Electrical resistance strain gage.	Inexpensive. Remote readout. Readout can be automated. Potential for accuracy and reliability. Most limitations listed opposite can be overcome if proper techniques are used.	Sensitive to temperature, moisture, cable length change in connections, construction damage. Requires substantial skill to install. Risk of zero drift.
Load in Tieback Anchors.	Telltale load cell.	Inexpensive. Simple. Calibrated in-place.	Access problems. Cannot be used with all proprietary anchor systems.
	Mechanical load cell.	Direct reading. Accurate and reliable. Rugged and durable.	

TABLE 16 (continued)  
Load and Temperature Devices in Walled Excavation Elements

Parameter	Instrument	Advantages	Limitations
	Electrical resistance strain gage load cell.	Remote readout. Readout can be automated.	Expensive. Sensitive to temperature, moisture, cable length change.
	Vibrating wire strain gage load cell.	Remote readout. Readout can be automated. Frequency signal permits data transmission over long distances.	Expensive. Sensitive to temperature. Risk of zero drift.
	Photelastic load cell.	Inexpensive.	Limited capacity. Access problems. Requires skill to read.
Temperature	Thermistor	Precise	Delicate, hence susceptible to damage. Sensitive to cable length.
	Thermocouple	Robust. Insensitive to cable length. Available in portable version as "surface pyrometer".	Less precise than thermistor, but premium grade can give $\pm 1^\circ\text{F}$ .

## REFERENCES

1. Naval Facilities Engineering Command, H.Q., Geotechnical Data Retrieval System, 1980.
2. Glass, C.E. and Slemmons, D.B., Imagery in Earthquake Analysis, Misc. paper S-73-1, State-of-the-Art for Assessing Earthquake Hazards in the United States, USCE, Waterways Experiment Station, Vicksburg, MS., 1978.
3. Way, S.G., Terrain Analysis, A Guide to Site Selection Using Aerial Photographic Interpretation, Dowden, Hutchinson and Ross, Inc., Stroudsburg, PA., 1973.
4. Hvorslev, M.J., Subsurface Exploration and Sampling for Civil Engineering Purposes, U.S. Army Engineer Waterways Experiment Station, Vicksburg, MS., 1949.
5. Higginbottom, I.E., The Use of Geophysical Methods in Engineering Geology, Part II, Electrical Resistivity, Magnetic and Gravity Methods, Ground Engineering, Vol. 9, No. 2, 1976.
6. Millet, R.A. and Morehouse, D.C., Bedrock Verification Program for Davis-Besse Nuclear Power Station, Proceedings of the Specialty Conference on Structural Design of Nuclear Plant Facilities, ASCE, 1973.
7. Brenner, R.P. and Phillipson, H.B., Sampling of Residual Soils in Hong Kong, Proceedings of the International Symposium of Soil Sampling, Singapore, 1979.
8. ASTM STP 501, Underwater Soil Sampling, Testing and Construction Control, 1972.
9. Lee, H.J. and Clausner, J.E., Seafloor Soil Sampling and Geotechnical Parameter Determination - Handbook, Civil Engineering Laboratory, Department of the Navy, August, 1979.
10. Marcuson, W.F. III, and Bieganouski, W.A., SPT and Relative Density in Coarse Sands, Journal of Geotechnical Engineering Division, ASCE, Vol. 103, No. GT 11, 1977.
11. Lacroix, Y. and Horn, H.M., Direct Determination and Indirect Evaluation of Relative Density and Earthwork Construction Projects, ASTM STP 523, 1973.
12. Ohsaki, Y., and Iwasaki, R., On Dynamic Shear Moduli and Poisson's Ratios of Soil Deposits, Soils and Foundations Vol. 13, No. 4, 1973.
13. Canadian Geotechnical Society, Properties of Soil and Rock, Canadian Foundation Engineering Manual, Part 1, Canadian Geotechnical Society, 1978.

14. Federal Highway Administration, Guidelines for Cone Penetration Tests Performance and Design, FHWA Report TS-28-209, 1977.
15. Acker Soil Sampling Catalog, Acker Drill Company, Inc., Scranton, PA.
16. Baguelin, F. and Jezequel, J.F., French Self-Boring Pressuremeter, PAF 68-PAF 72 and PAF 76, Report No. FHWA-TS-80-202, Federal Highway Administration, Washington, D.C., 1980.
17. Wroth, C.P., Cambridge In-Situ Probe, PAF 68-PAF 72 and PAF 76, Report No. FHWA-TS-80-202, Federal Highway Administration, Washington, D.C., 1980.
18. HUD, Public Health Service Health Manual of Septic Tank Practice, NTIS PB 218226.
19. ASTM STP 523, Evaluation of Relative Density and Its Role in Geotechnical Projects Involving Cohesionless Soils, 1972.
20. U.S. Corps of Engineers, Radiological Safety, ER385-1-80.
21. Noble, G., Sanitary Landfill Design Handbook, Technomic Publishing Co., Westport, CT., 1976.
22. United States Environmental Protection Agency (EPA), Process Design Manual, Municipal Sludge Landfills, EPA-625 11-78-010, SW 705, 1978.
23. Dunicliff, C.J., Geotechnical Instrumentation for Monitoring Field Performance, National Cooperative Highway Research Program, Synthesis of Highway Practice, Transportation Research Board, to be published 1981.
24. Dunicliff, C.J., Equipment for Field Deformation Measurements, Proceedings of the Fourth Panamerican Conference, SMFE, Vol. II, San Juan, Puerto Rico, January 1973.
25. Goldberg, D.T., Jaworski, W.E., and Gordon, M.D., Lateral Support Systems and Underpinning, Volume II Design Fundamentals, Report No. FHWA-RD-75-129, Federal Highway Administration, 1976.
26. Naval Facilities Engineering Command, Design Manuals (DM) and Publications (P).

DM-5.04	Pavements
P-418	Dewatering and Groundwater Control

Government agencies may obtain copies of design manuals and NAVFAC publications from the U.S. Naval Publications and Forms Center, 5801 Tabor Avenue, Philadelphia, Pennsylvania 19120. Nongovernment agencies and commercial firms may obtain copies from the Superintendent of Documents, U.S. Government Printing Office, Washington, D.C. 20402.

CHAPTER 3. LABORATORY TESTING

Section 1. INTRODUCTION

1. SCOPE. This chapter covers laboratory test procedures, typical test properties, and the application of test results to design and construction. Symbols and terms relating to tests and soil properties conform, generally, to definitions given in ASTM Standard D653, Standard Definitions of Terms and Symbols Relating to Soil and Rock Mechanics found in Reference 1, Annual Book of ASTM Standards, by the American Society for Testing and Materials.

2. RELATED CRITERIA. For additional requirements concerning laboratory tests for highway and airfield design, see the following:

Subject	Source
Airfield Pavements.....	NAVFAC DM-21 Series and DM-21.03
Pavements, Soil Exploration, and Subgrade Testing.....	NAVFAC DM-5.04

3. LABORATORY EQUIPMENT. For lists of laboratory equipment for performance of tests, see Reference 2, Soil Testing for Engineers, by Lambe, Reference 3, The Measurement of Soil Properties in the Triaxial Test, by Bishop and Henkel, and other criteria sources.

4. TEST SELECTION FOR DESIGN. Standard (ASTM) or suggested test procedures, variations that may be appropriate, and type and size of sample are included in Tables 1, 2, 3, and 4. Table 5 lists soil properties determined from such tests, and outlines the application of such properties to design. ASTM procedures are found in Reference 1.

a. Sample Selection. Samples to be tested should be representative, i.e. they should be similar in characteristics to most of the stratum from which they come, or be an average of the range of materials present. If this appears difficult because of variations in the stratum, it may be necessary to consider subdivisions of the stratum for sampling, testing, and design purposes. In general, tests on samples of mixed or stratified material, such as varved clay, should be avoided; usually such results are not indicative of material characteristics; and better data for analysis can be obtained by testing the different materials separately. Undisturbed samples for structural properties tests must be treated with care to avoid disturbance; an "undisturbed" sample found to be disturbed before testing normally should not be tested. Fine-grained cohesive samples naturally moist in the ground should not be allowed to dry before testing, as irreversible changes can occur; organic soils are particularly sensitive. Soils with chemical salts in the pore water may change if water is added, diluting the salt concentration, or if water is removed, concentrating or precipitating the salt. Organic soils require long-term low temperature (60deg.C) drying to avoid severe oxidation (burning) of the organic material.



TABLE 1  
Requirements for Index Properties Tests and Testing Standards

Test	Reference for Standard Test procedures[(a)]	Variations from Standard Test Procedures, Sample Requirements	Size or Weight of Sample for Test[(b)],[(c)]
Moisture content of soil	(1, ASTM D2216)	None. (Test requires unaltered natural moisture content.)	As large as convenient.
Moisture, ash, and organic matter of peat materials	(1, ASTM D2974)	None.	
Dry unit weight	None.	Determine total dry weight of a sample of measured total volume. (Requires undisturbed sample).	As large as convenient.
Specific gravity:			
Material smaller than No. 4 sieve size	(1, ASTM D854)	Volumetric flask preferable; vacuum preferable for de-airing.	25 to 50 for fine-grained soil; 150 gm for coarse-grained soils.
Material larger than No. 4 sieve size	(1, ASTM C127)	None.	500 gm.
Atterberg Limits:		Use fraction passing No. 40 sieve; material should not be dried before testing.	
Liquid limit	(1, ASTM D423)	None.	100 to 500 gm.
Plastic limit	(1, ASTM D424)	Ground glass plate preferable for rolling.	15 to 20 gm.
Shrinkage limit	(4)	In some cases a trimmed specimen of undisturbed material may be used rather than a remolded sample.	30 gm.

TABLE 1 (continued)  
 Requirements for Index Properties Tests and Testing Standards

Test	Reference for Standard Test procedures[(a)]	Variations from Standard Test Procedures, Sample Requirements	Size or Weight of Sample for Test[(b)],[(c)]
Gradation:			
Sieve analysis	(1, ASTM D422)	Selection of sieves to be utilized may vary for samples of different gradation.	500 gm for soil with grains to 3/8"; to 5,000 m for soil with grains to 3".
Hydrometer analysis	(1, ASTM D422)	Fraction of sample for hydrometer analysis may be that passing No. 200 sieve. For fine-grained soil entire sample may be used. All material must be smaller than No. 10 sieve.	65 gm for fine-grained soil; 115 gm for sandy soil.
Corrosivity:			
Sulphate content	(5)	Several alternative procedures in reference.	soil/water solution prepared, see reference.
Chloride content	(5)	Several alternative procedures in reference.	Soil/water solution prepared, see reference.
pH	(1, ASTM D1293)	Reference is for pH of water. For mostly solid substances, solution made with distilled water and filtrate tested; standard not available.	
Resistivity (laboratory)	None.	Written standard not available. Follow guidelines provided by manufacturers of testing apparatus.	
Resistivity (field)	(6)	In situ test procedure.	

TABLE 1 (continued)  
Requirements for Index Properties Tests and Testing Standards

- (a) Number in parenthesis indicates Reference number.
- (b) Samples for tests may either be disturbed or undisturbed; all samples must be representative and non-segregated; exceptions noted.
- (c) Weights of samples for tests on air-dried basis.

TABLE 2  
Requirements for Structural Properties

Test	Reference for Suggested Test Procedures (a)	Variations from Suggested Test Procedures	Size or Weight of Sample for Test (undisturbed, remolded, or compacted)
<u>Permeability:</u> Constant head procedure for moderately permeable soil	(2), (4)		Sample size depends on max. grain size, 4 cm dia. by 35 cm height for silt and fine sand.
Variable head procedure	(2), (4)	Generally applicable to fine-grained soils.	Similar to constant head sample.
Constant head procedure for coarse-grained soils	(4), (1), ASTM D2434	Limited to soils containing less than 10% passing No. 200 sieve size. For clean coarse-grained soil the procedure in (4) is preferable.	Sample diameter should be ten times the size of the largest soil particle.
Capillary head	(2)	Capillary head for certain fine-grained soils may have to be determined indirectly.	200 to 250 gm dry weight.
<u>Consolidation:</u> Consolidation	(2)	To investigate secondary compression, individual loads may be maintained for more than 24 hours.	Diameter preferably 2-1/2 in or larger. Ratio of diameter to thickness of 3 to 4.

TABLE 2 (continued)  
Requirements for Structural Properties

Test	Reference for Suggested Test Procedures (a)	Variations from Suggested Test Procedures	Size or Weight of Sample for Test (undisturbed, remolded, or compacted)
Swell	(7), AASHTO T258	-	Diameter preferably 2-1/2 in or larger. Ratio of diameter to thickness of 3 to 4.
Collapse potential	(8)	-	2 specimens for each test, with diameter 2-1/2 in or larger. Diameter to height ratio 3 to 4.
<u>Shear Strength:</u>			
Direct shear	(2), (1), ASTM D3080	Limited to tests on cohesionless soils or to consolidated shear tests on fine-grained soils.	Generally 0.5 in thick, 3 in by 3 in or 4 in by 4 in in plan, or equivalent circular cross section.
Unconfined compression	(2), (1), ASTM D2166	Alternative procedure given in Reference 4.	Similar to triaxial test samples.

TABLE 2 (continued)  
Requirements for Structural Properties

Test	Reference for Suggested Test Procedures(a)	Variations from Suggested Test Procedures	Size or Weight of Sample for Test (undisturbed, remolded, or compacted)
<u>Triaxial compression:</u>			
Unconsolidated - undrained (Q or UU)	(1, ASTM D2850)		Ratio of height to diameter should be less than 3 and greater than 2.
Consolidated-undrained (R or CU)	(2),(4)	Consolidated-undrained tests may run with or without pore pressure measurements, according to basis for design.	Common sizes are: 2.8 in dia., 6.5 in high. Larger sizes are appropriate for gravelly materials to be used in earth embankments.
Consolidated-drained (S or CD)	(2),(4)		
<u>Vane Shear</u>			Block of undisturbed soil at least three times dimensions of vane.

(a) Number in parenthesis indicates Reference number.

TABLE 3  
Requirements for Dynamic Tests

Test	Reference for Test Procedure (a),(b)	Variations from Standard Test Procedure	Size or Weight of Sample for Test
Cyclic Loading			
Triaxial compression	(9)		Same as for structural properties triaxial.
Simple shear	(9)		
Torsional shear	(10)	Can use hollow specimen.	
Resonant Column	(10) & (11)	Can use hollow specimen.	Same as for structural properties triaxial; length sometimes greater.
Ultrasonic pulse			
Soil	(12)		Same as for structural properties triaxial.
Rock	(1, ASTM D2845)		Prism, length less than 5 times lateral dimension; lateral dimension at least 5 times length of compression wave.
<p>(a) Number in parenthesis indicates Reference number.</p> <p>(b) Except for the ultrasonic pulse test on rock, there are no recognized standard procedures for dynamic testing. References are to descriptions of tests and test requirements by recognized authorities in those areas.</p>			

TABLE 4  
Requirements for Compacted Samples Tests

Test	Reference for Standard Test Procedures(a),(b)	Variations from Standard Test Procedures	Size or Weight of Sample for Test(c)
Moisture-density relations: Standard Proctor 5-1/2 lb. hammer, 12 in. drop	(1, ASTM D698)	Preferable not to reuse samples for successive compaction determinations.	Each determination (typically 4 or 5 determinations per test): Method A: 6 lbs Method B: 14 lbs Method C: 10 lbs Method D: 22 lbs
Modified Proctor 10 lb. hammer, 18 in. drop	(1, ASTM D1557)	Preferable not to reuse samples for successive compaction determinations.	Method A: 7 lbs Method B: 16 lbs Method C: 12 lbs Method D: 25 lbs
Maximum and Minimum Densities of Cohesionless Soils	(1, ASTM D2049), (4)		Varies from 10 to 130 lbs depending on max. grain size.
California Bearing Ratio	(1, ASTM D1883)	Compaction energy other than that for Modified Proctor may be utilized.	Each determination requires 15 to 25 lbs depending on gradation.
Resistance R-value	(1, ASTM D2844)		10 - 15 lbs depending on gradation.



TABLE 4 (continued)  
Requirements for Compacted Samples Tests

Test	Reference for Standard Test Procedures(a), (b)	Variations from Standard Test Procedures	Size or Weight of Sample for Test(c)
Expansion Pressure	(7, AASHTO T190)	Alternatively, testing procedures of Table 2 may be utilized.	10 - 15 lbs depending on gradation.
Permeability and compression	(13)	Best suited for coarse-grained soils. Alternatively, testing procedures of Table 2 may be utilized.	15 lbs of material passing No. 4 sieve size.

(a) Number in parenthesis indicates Reference number.  
(b) For other sources of standard test procedures, see Table 1.  
(c) Weight of samples for tests given on air-dried basis.

TABLE 5  
Soil Properties for Analysis and Design

Property	Symbol	Unit(a)	How Obtained	Direct Applications
<u>Volume-weight Characteristics(b)</u>				
Moisture Content	w	D	Direct from test	Classification and volume-weight relations.
Unit Weights	$\gamma$	FL-3	Directly from test or from volume-weight relations	Classification and pressure computations.
Porosity	n	D	Computed from volume-weight relations	Parameters used to represent relative volume of voids with respect to total volume of soil or volume of solids.
Void Ratio	e	D	Computed from volume-weight relations	
Specific Gravity	G	D	Directly from test	Volume computations.
<u>Plasticity Characteristics:</u>				
Liquid Limit	LL	D	Directly from test	Classification and properties correlation.
Plastic Limit	PL	D	Directly from test	
Plasticity Index	PI	D	LL-PL	

TABLE 5 (continued)  
Soil Properties for Analysis and Design

Property	Symbol	Unit(a)	How Obtained	Direct Applications
Shrinkage limit	SL	D	Directly from test.	Classification and computation of swell.
Shrinkage index	SI	D	PL-SL	Identification of clay mineral.
Activity	A <sub>c</sub>	D	$\frac{PI}{\% < 2 \text{ microns}}$	Estimating degree of preconsolidation, and soil consistency.
Liquidity index	LI	D	$\frac{w - PL}{PI}$	
<u>Gradation Characteristics:</u>				
Effective diameter	D <sub>10</sub>	L	From grain size curve.	Classification, estimating permeability and unit weight, filter design, grout selection, and evaluating potential frost heave and liquefaction.
Percent grain size	D <sub>30</sub> D <sub>60</sub> D <sub>85</sub>	L	From grain size curve.	
Coefficient of uniformity	C <sub>u</sub>	D	$\frac{D_{60}}{D_{10}}$	
Coefficient of curvature	C <sub>z</sub>	D	$\frac{(D_{30})^2}{(D_{10}) \times (D_{60})}$	
Clay size fraction	-	D	From grain size curve, % finer than 0.002 mm.	

TABLE 5 (continued)  
Soil Properties for Analysis and Design

Property	Symbol	Unit(a)	How Obtained	Direct Applications
<u>Drainage Characteristics:</u>				
Coefficient of permeability	k	L <sup>1</sup> T <sup>-1</sup>	Directly from permeability test or computed from consolidation test data.	Drainage, seepage, and consolidation analysis.
Capillary head	h <sub>c</sub>	L	Directly from test.	Drainage and drawdown analysis.
Effective porosity	n <sub>c</sub>	D	Directly from test for volume of drainable water.	
<u>Consolidation Characteristics:</u>				
Coefficient of compressibility	a <sub>v</sub>	L <sup>2</sup> F <sup>-1</sup>	Determined from natural plot of e vs. p curve.	Computation of ultimate settlement or heave in consolidation analysis.
Coefficient of volume compressibility	m <sub>v</sub>	L <sup>2</sup> F <sup>-1</sup>	$\frac{a_v}{1 + e}$	
Compression index	C <sub>c</sub>	D		Computation of ultimate settlement or swell in consolidation analysis.
Recompression index	C <sub>r</sub>	D	Determined from e vs. log p curve.	
Swelling index	C <sub>s</sub>	D		

TABLE 5 (continued)  
Soil Properties for Analysis and Design

Property	Symbol	Unit(a)	How Obtained	Direct Applications
Coefficient of secondary compression	C	D	Determined from semilog time-consolidation curve.	Computation of time rate of settlement.
Coefficient of consolidation	$c_v$	$L^2T^{-1}$		
Preconsolidation pressure	$P_c$	FL <sup>-2</sup>	Estimate from e vs. log p curve.	Settlement analysis.
Overconsolidation ratio	OCR	D	$\frac{P_c}{p_0}$	Basis for normalizing behavior of clay.
Shear Strength Characteristics:				
Apparent angle of shearing resistance	$\phi$	A	Determined from Mohr circle plot of shear test data for total stress.	
Cohesion intercept	c	FL <sup>-2</sup>		
Effective angle of shearing resistance	$\phi'$	A	Determined from Mohr circle plot of effective stress shear test data (drained tests with pore pressure measurements).	
Effective cohesion	$c'$	FL <sup>-2</sup>		

TABLE 5 (continued)  
Soil Properties for Analysis and Design

Property	Symbol	Unit(a)	How Obtained	Direct Applications
Unconfined compressive strength	$q_u$	FL-2	Directly from test.	Analysis of stability, load carrying capacity of foundations, lateral earth load.
Undrained shear strength	$s_u$	FL-2	<u>undisturbed strength</u> remolded strength	
Sensitivity	$S_t$	D		
Modulus of elasticity or Young's modulus	$E_s$	FL-2	Determined from stress-strain curve or dynamic test.	
<u>Compaction Characteristics:</u>				
Maximum dry unit weight	$\gamma_{max}$	FL-3	Determined from moisture-dry unit weight curve.	Compaction criterion.
Optimum moisture content	OMC	D		
Maximum and minimum density of cohesionless soils	$\gamma_d$ max $\gamma_d$ min	FL-3 FL-3	Directly from test.	
<u>Characteristics of Compacted Samples:</u>				
Percent compaction	-	D	$\frac{\gamma}{\gamma_{max}}$	Compaction control, properties correlation.
Needle penetration resistance	$P_r$	FL-2	Directly from test.	Moisture control of compaction.

TABLE 5 (continued)  
Soil Properties for Analysis and Design

Property	Symbol	Unit(a)	How Obtained	Direct Applications
Relative density	$D_r$	D	Determined from results of max. and min. density tests.	Compaction control, properties correlation, liquefaction studies.
California Bearing Ratio	CBR	D	Directly from test.	Pavement design, compaction control.
<b>Dynamic Characteristics:</b>				
Shear modulus	G	FL <sup>-2</sup>	Determined from resonant column, cyclic simple shear, ultrasonic pulse, or dynamic triaxial tests.	Analysis of foundation and soil behavior under dynamic loading.
Damping ratios Rod (longitudinal) Shear (torsional)	- $D_L$ $D_T$	D	Determined from resonant column test, dynamic triaxial, or cyclic simple shear test.	
Resonant frequency longitudinal torsional	- $f_L$ $f_T$	T <sup>-1</sup>	Determined from resonant column test.	

(a) Units F = Force or weight; L = Length; T = Time; D = Dimensionless; A = Angular Measure

(b) For complete list of volume - weight relationships, see Table 6

b. Index Properties Tests. Index properties are used to classify soils, to group soils in major strata, to obtain estimates of structural properties (see correlations in this Chapter), and to correlate the results of structural properties tests on one portion of a stratum with other portions of that stratum or other similar deposits where only index test data are available. Procedures for most index tests are standardized (Table 1). Either representative disturbed or undisturbed samples are utilized. Tests are assigned after review of boring data and visual identification of samples recovered. For a simple project with 4 to 6 borings, at least 3 gradation and/or Atterberg tests should be made per significant stratum (5 to 15 feet thick). For complex soil conditions, thick strata, or larger sites with more borings, additional tests should be made. Moisture content tests should be made liberally on samples of fine-grained soil. In general, the test program should be planned so that soil properties and their variation can be defined adequately for the lateral and vertical extent of the project concerned.

c. Tests for Corrosivity. The likelihood of soil adversely affecting foundation elements or utilities (concrete and metal elements) can be evaluated on a preliminary basis from the results of the tests referenced in Table 1. The tests should be run on samples of soil which will be in contact with the foundations and/or utilities in question; typically these will be only near-surface materials. For a simple project with uniform conditions, three sets of tests may be adequate. Usually the chemical tests are run only if there is reason to suspect the presence of those ions. (See DM-5.7 for application of test results and possible mitigating measures.)

d. Structural Properties Tests. These must be planned for particular design problems. Rigid standardization of test programs is inappropriate. Perform tests only on undisturbed samples obtained as specified in Chapter 2 or on compacted specimens prepared by standard procedures. In certain cases, completely remolded samples are utilized to estimate the effect of disturbance. Plan tests to determine typical properties of major strata rather than arbitrarily distributing tests in proportion to the number of undisturbed samples obtained. A limited number of high quality tests on carefully selected representative undisturbed samples is preferred. In general, selecting design values requires at least three test values for simple situations of limited areal extent; larger and more complex conditions require several times these numbers.

Where instantaneous deformation characteristics of soils are to be evaluated, constitutive relationships of the materials in question must also be established. For initial estimates of Young's modulus,  $E_s$ , see Chapter 5, and for  $K_o$  value, see DM-7.2, Chapter 3.

e. Dynamic Tests. Dynamic testing of soil and rock involves three ranges: low frequency (generally less than 10 hertz) cyclic testing, resonant column high frequency testing, and ultrasonic pulse testing. The dynamic tests are used to evaluate foundation support characteristics under repeated loadings such as a drop forge, traffic, or earthquake; a primary concern is often liquefaction. Young's modulus ( $E_s$ ), shear modulus ( $G$ ), and damping characteristics are determined by cyclic triaxial and simple shear tests. Resonant column can be used to determine  $E_s$ ,  $G$ , and damping.



From the resonant frequency of the material in longitudinal, transverse, and torsional modes, Poisson's ratio ( $\nu$ ) can be computed from test data. Foundation response to dynamic loading, and the effect of wave energy on its surroundings is studied in the light of these test results. The ultrasonic pulse test also evaluates the two moduli and Poisson's ratio, but the test results are more reliable for rocks than for soils.

Dynamic tests can be run on undisturbed or compacted samples, but should be run only if the particular project really requires them. The number of tests depends on project circumstances. Estimates of dynamic parameters can be obtained from correlations with other properties (see references in Section 6 of this chapter).

f. Compaction Tests. In prospecting for borrow materials, index tests or compaction tests may be required in a number proportional to the volume of borrow involved or the number of samples obtained. Structural properties tests are assigned after borrow materials have been grouped in major categories, by index and compaction properties. Select samples for structural tests to represent the main soil groups and probable compacted condition. At least one compaction or relative density test is required for each significantly different material (based on gradation or plasticity). Numbers of other tests depend on project requirements.

g. Typical Test Properties. Various correlations between index and structural properties are available showing the probable range of test values and relation of parameters. In testing for structural properties, correlations can be used to extend results to similar soils for which index values only are available. Correlations are of varying quality, expressed by standard deviation, which is the range above and below the average trend, within which about two-thirds of all values occur. These relationships are useful in preliminary analyses but must not supplant careful tests of structural properties. The relationships should never be applied in final analyses without verification by tests of the particular material concerned.

## Section 2. INDEX PROPERTIES TESTS

1. MOISTURE CONTENT, UNIT WEIGHT, SPECIFIC GRAVITY. Index properties tests are used to compute soil volume and weight components (Table 6). Ordinarily, determine moisture content for all the representative samples (disturbed or undisturbed) for classification and grouping of materials in principal strata. See Table 1 for test standards.

a. Unsaturated Samples. Measure moisture content, dry weight, specific gravity, and total volume of specimen to compute volume-weight relationships.

b. Saturated Samples. If moisture content and dry weight are measured, all volume-weight parameters may be computed by assuming a specific gravity. If moisture content and specific gravity are measured, all volume-weight parameters may be computed directly. Volume-weight of fine-grained soils below the water table may be determined with sufficient accuracy by assuming saturation.

TABLE 6 :  
Volume and Weight Relationships

		VOLUME COMPONENTS		WEIGHT COMPONENTS		WEIGHTS FOR UNIT VOLUME OF SOIL	
		SOIL SAMPLE		SOIL SAMPLE		SOIL SAMPLE	
		SATURATED SAMPLE ( $W_s, W_w, G, V_s$ ARE KNOWN)		UNSATURATED SAMPLE ( $W_s, W_w, G, V_s$ ARE KNOWN)		UNSATURATED SAMPLE ( $W_s, W_w, G, V_s$ ARE KNOWN)	
PROPERTY							
VOLUME OF SOLIDS	$V_s$	$V_s$	$V_s$	$V_s$	$V_s$	$V_s$	$V_s$
VOLUME OF WATER	$V_w$	$V_w$	$V_w$	$V_w$	$V_w$	$V_w$	$V_w$
VOLUME OF AIR OR GAS	$V_a$	ZERO	$V - (V_s + V_w)$	$V - (V_s + V_w)$	$V - (V_s + V_w)$	$V - (V_s + V_w)$	$V - (V_s + V_w)$
VOLUME OF VOIDS	$V_v$	$V_v$	$V - \frac{W_w}{\gamma_w}$	$V - \frac{W_w}{\gamma_w}$	$V - \frac{W_w}{\gamma_w}$	$V - \frac{W_w}{\gamma_w}$	$V - \frac{W_w}{\gamma_w}$
TOTAL VOLUME OF SAMPLE	$V$	MEASURED	$V_s + V_w$	MEASURED	$V_s + V_w + V_a$	$V_s + V_w + V_a$	$V_s + V_w + V_a$
POROSITY	$n$		$\frac{V_v}{V}$		$1 - \frac{V_s}{V}$	$1 - \frac{V_s}{V}$	$1 - \frac{V_s}{V}$
VOID RATIO	$e$		$\frac{V_v}{V_s}$		$\frac{V - V_s}{V_s}$	$\frac{V - V_s}{V_s}$	$\frac{V - V_s}{V_s}$
SUPPLEMENTARY FORMULAS RELATING MEASURED AND COMPUTED FACTORS							
VOLUME COMPONENTS							
VOLUME OF SOLIDS	$V_s$	$V_s$	$\frac{W_s}{G\gamma_w}$	$\frac{W_s}{G\gamma_w}$	$V - (V_a + V_w)$	$V(1-n)$	$\frac{V}{(1+e)}$
VOLUME OF WATER	$V_w$	$V_w$	$\frac{W_w}{\gamma_w}$	$\frac{W_w}{\gamma_w}$	$V - V_a$	$S V_v$	$\frac{S V_e}{(1+e)}$
VOLUME OF AIR OR GAS	$V_a$	ZERO	$V - (V_s + V_w)$	$V - (V_s + V_w)$	$V - V_w$	$(1-S)V_v$	$\frac{(1-S)V_e}{(1+e)}$
VOLUME OF VOIDS	$V_v$	$V_v$	$V - \frac{W_w}{\gamma_w}$	$V - \frac{W_w}{\gamma_w}$	$V - V_s$	$\frac{V_s n}{1-n}$	$\frac{V_e}{(1+e)}$
TOTAL VOLUME OF SAMPLE	$V$	MEASURED	$V_s + V_w$	MEASURED	$V_s + V_w + V_a$	$\frac{V_s}{1-n}$	$V_s(1+e)$
POROSITY	$n$		$\frac{V_v}{V}$		$1 - \frac{V_s}{V}$	$1 - \frac{W_s}{GV\gamma_w}$	$\frac{e}{1+e}$
VOID RATIO	$e$		$\frac{V_v}{V_s}$		$\frac{V - V_s}{V_s}$	$\frac{GV\gamma_w}{W_s} - 1$	$\frac{W_w G}{W_s S}$
							$\frac{n}{1-n}$
							$\frac{W_w G}{W_s S}$

TABLE 6 (continued)  
Volume and Weight Relationships

PROPERTY	SATURATED SAMPLE ( $W_s, W_w, G_s$ ARE KNOWN)		UNSATURATED SAMPLE ( $W_s, W_w, G_s, V_s$ ARE KNOWN)		SUPPLEMENTARY FORMULAS RELATING MEASURED AND COMPUTED FACTORS		
	$W_s, W_w, G_s$ ARE KNOWN	MEASURED	$W_s, W_w, G_s, V_s$ ARE KNOWN	MEASURED	$\frac{W_T}{(1+w)}$	$G V \gamma_s (1-n)$	$\frac{W_w G}{e S}$
WEIGHT OF SOLIDS $W_s$		MEASURED		MEASURED			
WEIGHT OF WATER $W_w$		MEASURED		MEASURED	$w W_s$	$S \gamma_w V_v$	$\frac{e W_s S}{G}$
TOTAL WEIGHT OF SAMPLE $W_T$		$W_s + W_w$		$W_s + W_w$	$W_s (1+w)$		
DRY UNIT WEIGHT $\gamma_D$	$\frac{W_s}{V_s + V_w}$	$\frac{W_s}{V}$	$\frac{W_s}{V_s + V_w}$	$\frac{W_s}{V}$	$\frac{W_T}{V(1+w)}$	$\frac{G \gamma_w}{(1+e)}$	$\frac{G \gamma_w}{1+w G/S}$
WET UNIT WEIGHT $\gamma_T$	$\frac{W_s + W_w}{V_s + V_w}$	$\frac{W_s + W_w}{V}$	$\frac{W_s + W_w}{V_s + V_w}$	$\frac{W_s + W_w}{V}$	$\frac{W_T}{V}$	$\frac{(G+Se)\gamma_w}{(1+e)}$	$\frac{(1+w)\gamma_w}{wS+1/G}$
SATURATED UNIT WEIGHT $\gamma_{SAT}$	$\frac{W_s + W_w}{V_s + V_w}$	$\frac{W_s + V_v \gamma_w}{V}$	$\frac{W_s + W_w}{V_s + V_w}$	$\frac{W_s + V_v \gamma_w}{V}$	$\frac{W_s}{V} \left( \frac{e}{1+e} \right) \gamma_w$	$\frac{(G+e)\gamma_w}{(1+e)}$	$\frac{(1+w)\gamma_w}{w+1/G}$
SUBMERGED (BUOYANT) UNIT WEIGHT $\gamma_{SUB}$		$\gamma_{SAT} - \gamma_w$		$\gamma_{SAT} - \gamma_w$	$\frac{W_s}{V} \left( \frac{1}{1+e} \right) \gamma_w$	$\frac{(G+e-1)\gamma_w}{(1+e)}$	$\frac{(-1/G)}{(e+1/G)} \gamma_w$
MOISTURE CONTENT $w$		$\frac{W_w}{W_s}$		$\frac{W_w}{W_s}$	$\frac{W_T}{W_s} - 1$	$\frac{S_w}{G}$	$s \left[ \frac{\gamma_w}{\gamma_D} - \frac{1}{G} \right]$
DEGREE OF SATURATION $S$	1.00	$\frac{V_w}{V_v}$	1.00	$\frac{V_w}{V_v}$	$\frac{W_w}{V_v \gamma_w}$	$\frac{w G}{e}$	$\left[ \frac{\gamma_w}{\gamma_D} - \frac{1}{G} \right]$
SPECIFIC GRAVITY $G$		$\frac{W_s}{V_s \gamma_w}$		$\frac{W_s}{V_s \gamma_w}$	$\frac{S_w}{w}$		

2. GRADATION. In addition to their use in classification, grain-size analyses may be applied to seepage and drainage problems, filter and grout design, and evaluation of frost heave. See Table 1 for test standards.

a. Grain-Size Parameters. Coefficient of uniformity,  $C_u$ , and coefficient of curvature,  $C_z$ , are computed from  $D_{60}$ ,  $D_{30}$ , and  $D_{10}$ , which are particle size diameter corresponding respectively to 60%, 30%, and 10% passing on the cumulative particle size distribution curves.  $C_u$  and  $C_z$  indicate the relative broadness or narrowness of gradation.  $D_{10}$  is an approximate measure of the size of the void spaces in coarse-grained soils. See Chapter 1.

b. Testing Program. Gradations of a large number of samples usually are not required for identification. Samples should be grouped in principal strata by visual classification before performing grain-size analyses on specimens of major strata.

3. ATTERBERG LIMITS. For classification of the fine-grained soils by Atterberg Limits, see Chapter 1. In addition to their use in soil classification, Atterberg Limits also are indicators of structural properties, as shown in the correlations in this chapter. Atterberg Limit tests should be performed discriminately, and should be reserved for representative samples selected after evaluating subsoil pattern. Determine Atterberg Limits of each consolidation test sample and each set of samples grouped for triaxial shear tests. For selected borings, determine Atterberg Limits on samples at regular vertical intervals for a profile of Limits and corresponding natural water content. See Table 1 for test standards.

### Section 3. PERMEABILITY TESTS

1. APPLICATIONS. Permeability coefficient is used to compute the quantity and rate of water flow through soils in drainage and seepage analysis. Laboratory tests are appropriate for undisturbed samples of fine-grained materials and compacted materials in dams, filters, or drainage structures. See Table 2 for test standards and recommended procedures.

a. Fine-Grained Soils. Permeability of fine-grained soils (undisturbed or compacted) generally is computed from consolidation test data or by direct measurement on consolidation or triaxial shear specimens. For soils with permeability less than  $10^{-6}$  cm/sec, a sealant must be used between the specimen and the wall of the permeameter.

b. Sand Drain Design. Sand drain design may require complete permeability data for soils to be stabilized, including determination of permeabilities in both vertical and horizontal direction.

c. Field Permeability Tests. The secondary structure of in situ soils, stratification, and cracks have a great influence on the permeability. Results of laboratory tests should be interpreted with this in mind, and field permeability tests (Chapter 2) should be performed where warranted.

2. TYPICAL VALUES. Coefficient of permeability is a property highly sensitive to sample disturbance, and shows a wide range of variation due to differences in structural characteristics. See Reference 14, Soil Mechanics in Engineering Practice, Terzaghi and Peck, for correlations of permeability with soil type. Permeability of clean, coarse-grained samples is related to  $D_{10}$ , size (Figure 1).

#### Section 4. CONSOLIDATION TESTS

1. UTILIZATION. One-dimensional consolidation tests with complete lateral confinement are used to determine total compression of fine-grained soil under an applied load and the time rate of compression caused by gradual volume decrease that accompanies the squeezing of pore water from the soil. See Figure 2 for test relationships.

2. TESTING PROGRAM. Consolidation tests require undisturbed samples of highest quality. Select samples representative of principal compressible strata. Determination of consolidation characteristics of a stratum requires from two to about eight tests, depending on the complexity of conditions. Select loading program to bracket anticipated field loading conditions.

a. Incremental Loading (IL) With Stress Control. Ordinarily, apply loads starting at 1/4 tsf and increase them by doubling 1/2, 1, 2, 4, 8, etc., tsf. For soils with pronounced swelling tendency, it may be necessary to rapidly increase loading to 1/2 tsf or higher, perhaps to overburden pressure, to prevent initial swell. For soft, normally consolidated soils, start loading at 1/16 or 1/32 tsf and increase loads by doubling the previous value. (See Reference 2.) To establish the reconsolidation index  $C_r$ , and swelling index  $C_s$ , include an unload-reload cycle, after  $P+c$ , has been reached. Unload must be to 1/8 the existing load, or preferably less. Reloads should be applied in the same manner as for the initial curve.

b. Constant Rate of Strain (CRS). The specimen is subjected to a constantly changing load while maintaining a constant rate of strain. Pore pressure is continuously monitored to ensure that the primary consolidation is completed at the applied strain rate. These tests can be performed in shorter time than IL tests and yield more accurate values of preconsolidation pressure  $P+c$ . Coefficient of consolidation  $c_v$ , values can be determined for very small load increments, but the test equipment is more complicated and requires that estimates of strain rate and  $P+c$ , be made prior to the start of the test. See Reference 15, Consolidation at Constant Rate of Strain, by Wissa, et al., for guidance.

c. Gradient Controlled Test (GC). Drainage is permitted at the upper porous stone while pore pressure is measured at the lower porous stone. A loading control system regulates the application of load so that a predetermined hydrostatic excess pressure is maintained at the bottom of the specimen. This method as well as CRS has similar advantages over IL, but does not require a prior estimate of strain rate. However, the equipment is more complex than for CSR. See Reference 16, New Concepts in Consolidation and Settlement Analysis, by Lowe, for guidance.

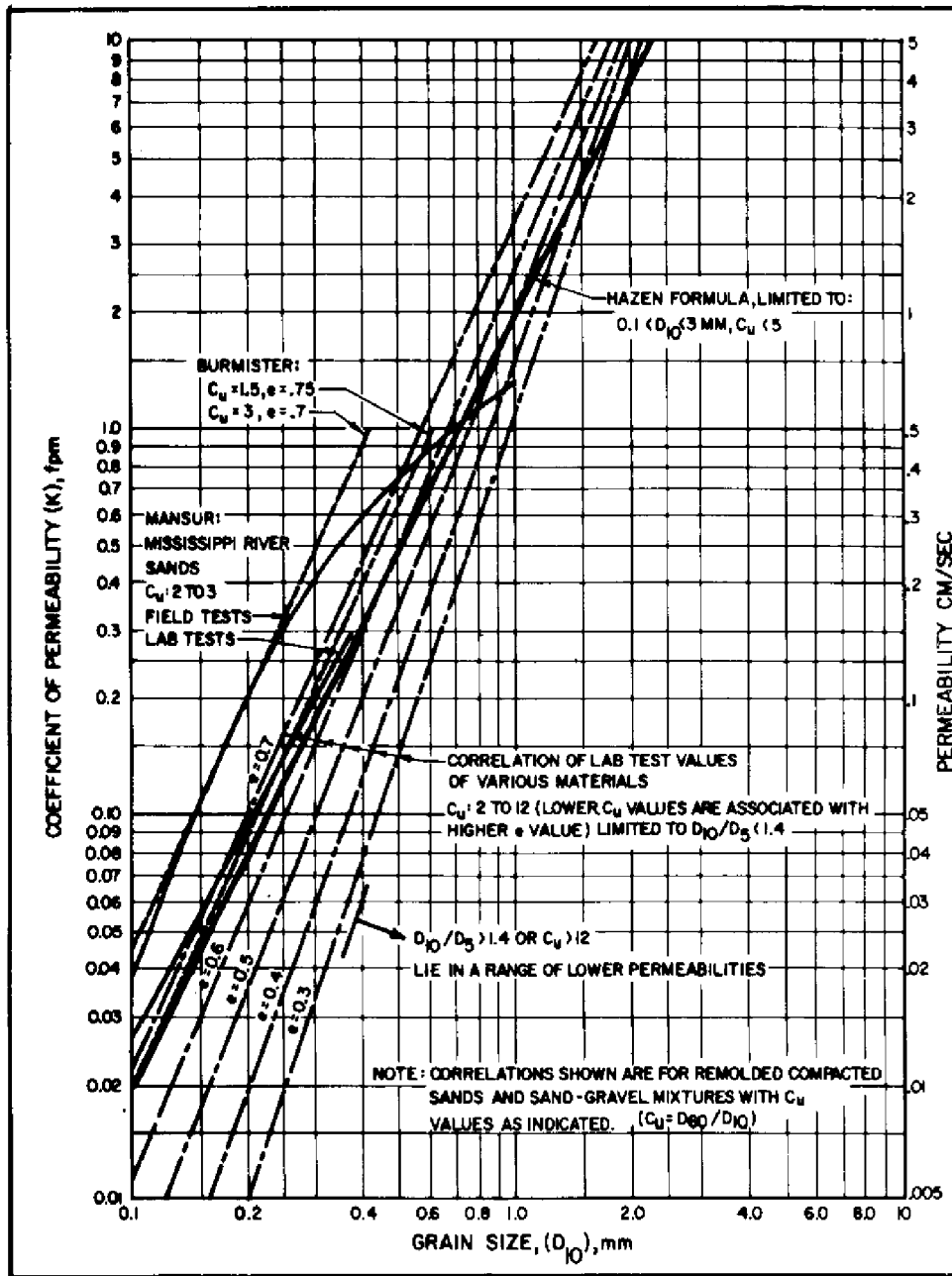

FIGURE 1  
 Permeability of Sands and Sand-Gravel Mixtures

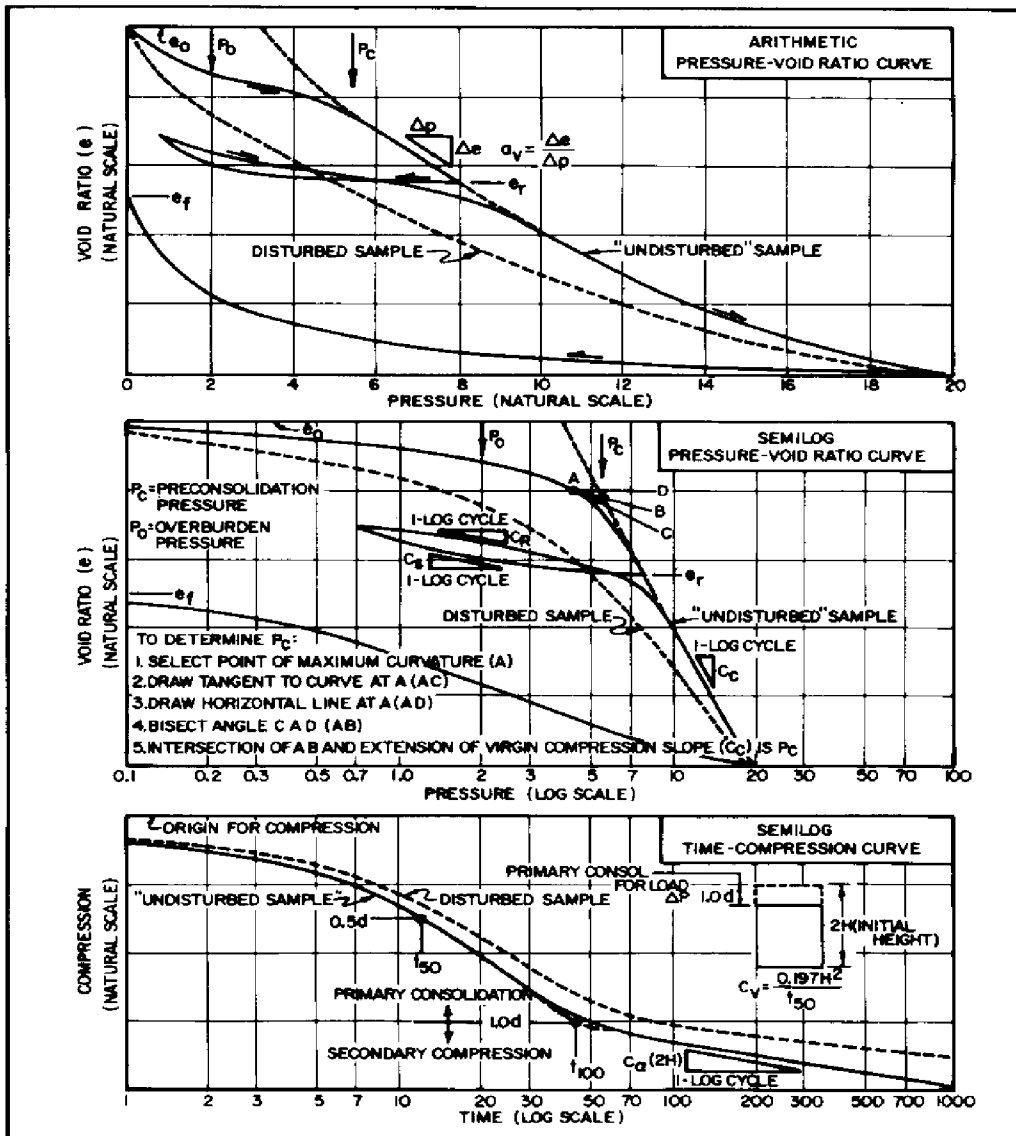

FIGURE 2  
 Consolidation Test Relationships

3. PRECONSOLIDATION PRESSURE. This pressure value,  $P+c$ , forms the boundary between recompression and virgin compression ranges and is approximately the maximum normal effective stress to which the material in situ has been consolidated by a previous loading. Desiccation produces a similar effect. The preconsolidation pressure cannot be determined precisely, but can be estimated from consolidation tests on high quality undisturbed samples.

a. Graphical Determination. Estimate preconsolidation pressure from semilogarithmic pressure-void ratio curve using the procedure given in the central panel of Figure 2. Alternative methods are given in Reference 17, Foundation Engineering, by Leonards, and Reference 18, The Undisturbed Consolidation of Clay, by Schmertmann. Maximum test pressures should exceed preconsolidation by an amount sufficient to define the slope of virgin compression. Generally, this requires application of three or more load increments exceeding the preconsolidation value.

b. Approximate Values. See Figure 3 for a relationship between preconsolidation pressure and liquidity index. For samples with natural moisture at the liquid limit (liquidity index of 1), preconsolidation ranges between about 0.1 and 0.8 tsf depending on soil sensitivity. For natural moisture at the plastic limit (liquidity index equal to zero), preconsolidation ranges from about 12 to 25 tsf.

$$\begin{matrix} q+u, /2 \\ ))))))) \end{matrix}$$

Alternately estimate:  $P+c = 0.11 + 0.0037 PI$  in which  $q+u$ , is the unconfined compressive strength, and  $PI$  is the soil plasticity index.

4. VIRGIN COMPRESSION. Virgin compression is deformation caused by loading in the range of pressures exceeding that to which the sample has been subjected in the past.

a. Compression Index. The semilogarithmic, pressure-void ratio curve is roughly linear in the virgin range. The semilogarithmic, straight line slope for virgin compression is expressed by the compression index  $C+c$ . (See Figure 2.)

b. Approximate Values. The compression index of silts, clays, and organic soils has been correlated with the natural water content, initial void ratio and the liquid limit. Approximate correlations are given in Chapter 5. The approximate values of  $C+c$ , for uniform sands in the load range of 1 to 4 tsf may vary from 0.05 to 0.06 (loose condition), and from 0.02 to 0.03 (dense condition).

5. RECOMPRESSION AND SWELL. Depending on the magnitude of preconsolidation, pressures applied by new construction may lie partly or wholly in the recompression range. If the load is decreased by excavation, fine-grained soil will undergo a volumetric expansion in the stress range below preconsolidation.

a. Swelling Index. The slope of straight-line rebound of the semilogarithmic pressure-void ratio curve is defined by  $C+s$ , (see Figure 2). The swelling index is generally one-fifth to one-tenth of the compression index except for soils with very high swell potential. For typical values of  $C+s$ , see Chapter 5.



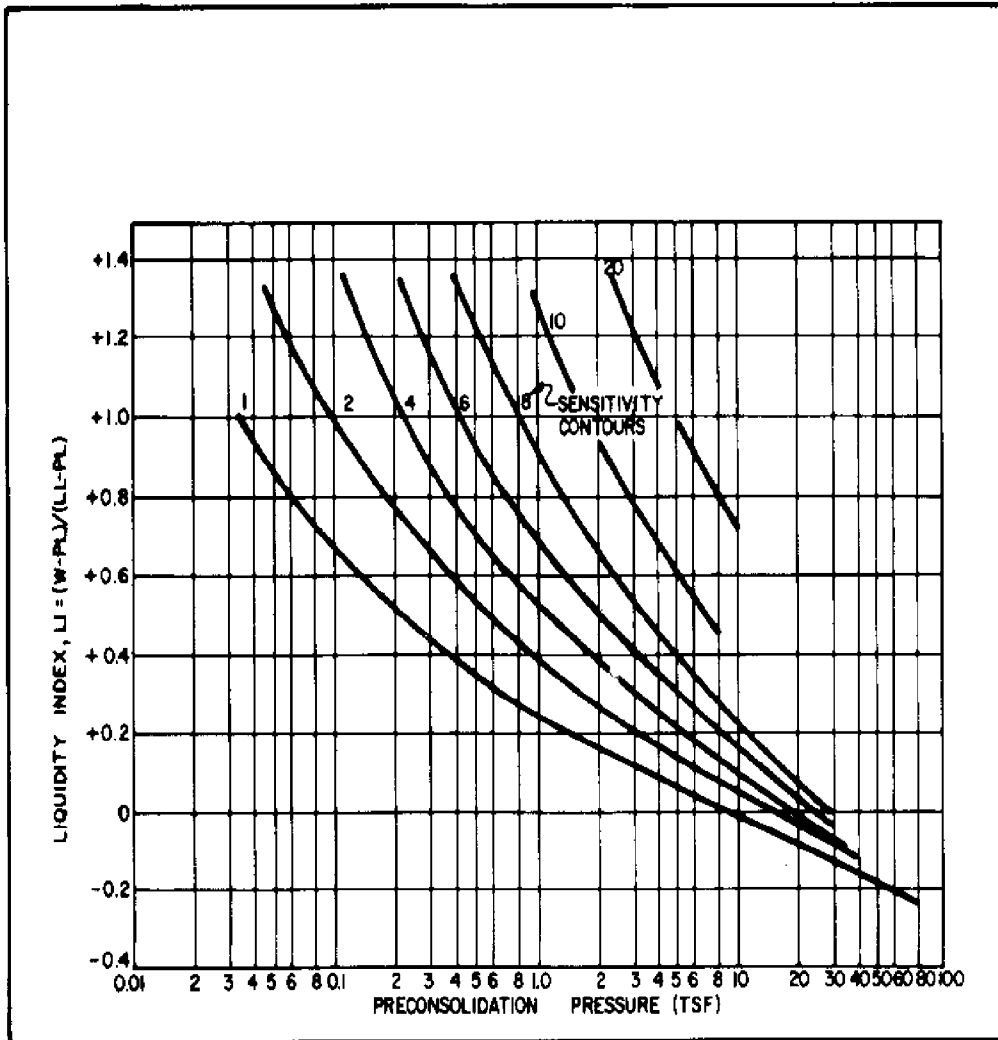

FIGURE 3  
Preconsolidation Pressure vs. Liquidity Index

b. Recompression Index. The slope of the straight line in the recompression range of the semilogarithmic pressure-void ratio curve is defined by  $C_r$ , where  $C_r$  is equal to or less than  $C_s$ . (See Figure 2).

6. COMPRESSION OF COLLAPSIBLE SOILS. Such soils require a special test for determining their collapse potential. See Chapter 1 for test details.

7. COEFFICIENT OF CONSOLIDATION ( $c_v$ ). Those soil properties that control the drainage rate of pore water during consolidation are combined in the coefficient of consolidation.

a. Determination. Compute  $c_v$  from the semilogarithmic time-compression curve for a given load increment (bottom panel of Figure 2). Correct the origin for compression for the effect of air or gas in void spaces by the procedure given in Reference 2.

b. Approximate Values. Figure 4 may be used to determine approximate values of  $c_v$ .

8. SECONDARY COMPRESSION. After completion of primary consolidation under a specific load, the semilogarithmic time-compression curve continues approximately as a straight line. This is termed secondary compression (Figure 2). It occurs when the rate of compression is no longer primarily controlled by the rate at which pore water can escape; there are no excess pore pressures remaining.

a. Organic Materials. In organic materials, secondary compression may dominate the time-compression curve, accounting for more than one-half of the total compression, or even obliterating the change in slope used to establish the limit of primary compression.

b. Approximate Values. The coefficient of secondary compression  $C_{\alpha}$ , is a ratio of decrease in sample height to initial sample height for one cycle of time on log scale. See bottom panel of Figure 4 for typical values.

9. SAMPLE DISTURBANCE. Sample disturbance seriously affects the values obtained from consolidation tests as shown in Figure 2 and below.

a. Void Ratio. Sample disturbance lowers the void ratio reached under any applied pressure and makes the location of the preconsolidation stress less distinct.

b. Preconsolidation Pressure. Sample disturbance tends to lower the compression index ( $C_c$ ) and the preconsolidation pressure ( $P_c$ ) obtained from the test curve.

c. Recompression and Swelling. Sample disturbance increases the recompression and swelling indices.

d. Coefficient of Consolidation. Sample disturbance decreases coefficient of consolidation for both recompression and virgin compression. For an undisturbed sample,  $c_v$  usually decreases abruptly at preconsolidation stress. This trend is not present in badly disturbed samples.

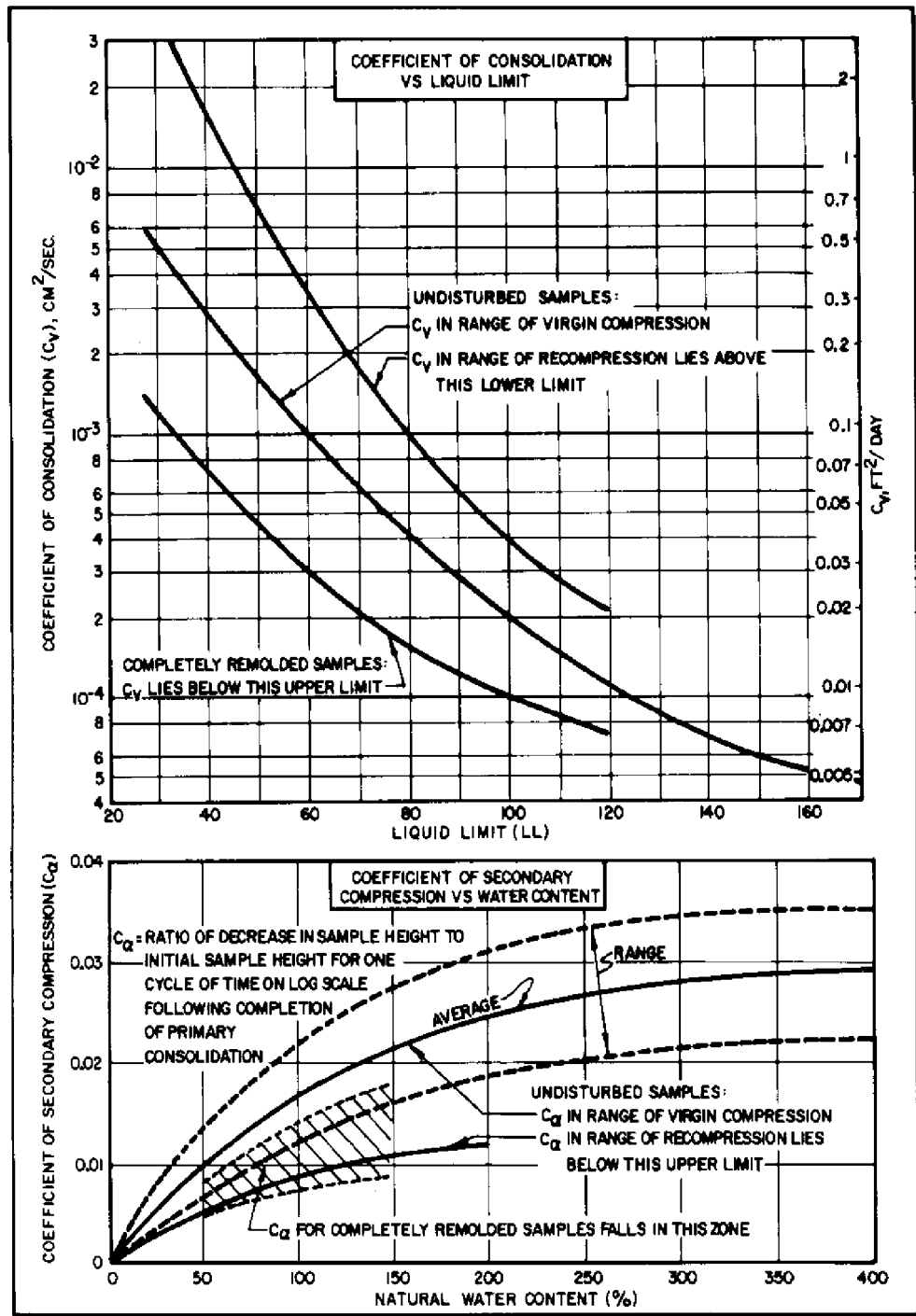

FIGURE 4  
 Approximate Correlations for Consolidation Characteristics  
 of Silts and Clays

e. Coefficient of Secondary Compression. Sample disturbance tends to decrease the coefficient of secondary compression in virgin compression loading range.

## Section 5. SHEAR STRENGTH TESTS

1. UTILIZATION. The shear strength of soil is required for the analysis of all foundation and earthwork stability problems. Shear strength can be determined by laboratory and field tests, and by approximate correlations with grain size, water content, density, and penetration resistance.

2. TYPES OF SHEAR TESTS. Many types and variations of shear tests have been developed. In most of these tests the rate of deformation is controlled and the resulting loads are measured. In some tests total stress parameters are determined, while in others effective stress strength parameters are obtained. See Chapter 4 for a discussion of total and effective stress concepts. The following are the most widely used testing procedures:

a. Direct Shear Test. A thin soil sample is placed in a shear box consisting of two parallel blocks. The lower block is fixed while the upper block is moved parallel to it in a horizontal direction. The soil fails by shearing along a plane assumed to be horizontal.

This test is relatively easy to perform. Consolidated-drained tests can be performed on soils of low permeability in a short period of time as compared to the triaxial test. However, the stress, strain, and drainage conditions during shear are not as accurately understood or controlled as in the triaxial test.

b. Unconfined Compression Test. A cylindrical sample is loaded in compression. Generally failure occurs along diagonal planes where the greatest ratio of shear stress to shear strength occurs. Very soft material may not show diagonal planes of failure but generally is assumed to have failed when the axial strain has reached a value of 20 percent. The unconfined compression test is performed only on cohesive soil samples. The cohesion (c) is taken as one-half the unconfined compressive strength.

c. Triaxial Compression Test. A cylindrical sample is confined by a membrane and lateral pressure is applied; pore water drainage is controlled through tubing connected to porous discs at the ends of the sample. The triaxial test (Figure 5) permits testing under a variety of loading and drainage conditions and also allows measurement of pore water pressure. For details on testing procedures, see Reference 2. Triaxial shear test relationships are shown graphically in Figure 6.

(1) Unconsolidated-Undrained (UU) or Quick Test (Q). In the UU test the initial water content of the test specimen is not permitted to change during shearing of the specimen.

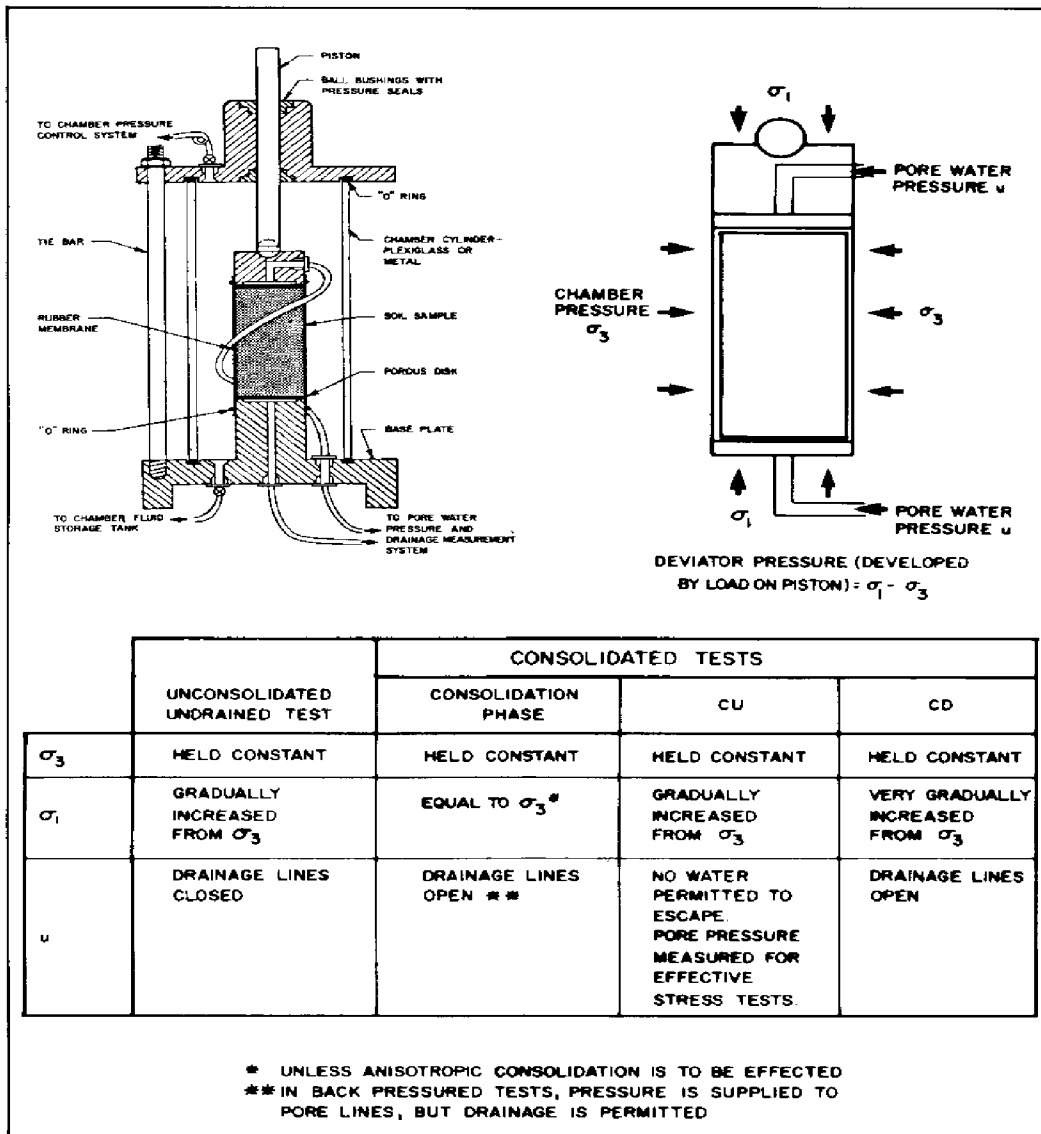

FIGURE 5  
Triaxial Apparatus Schematic

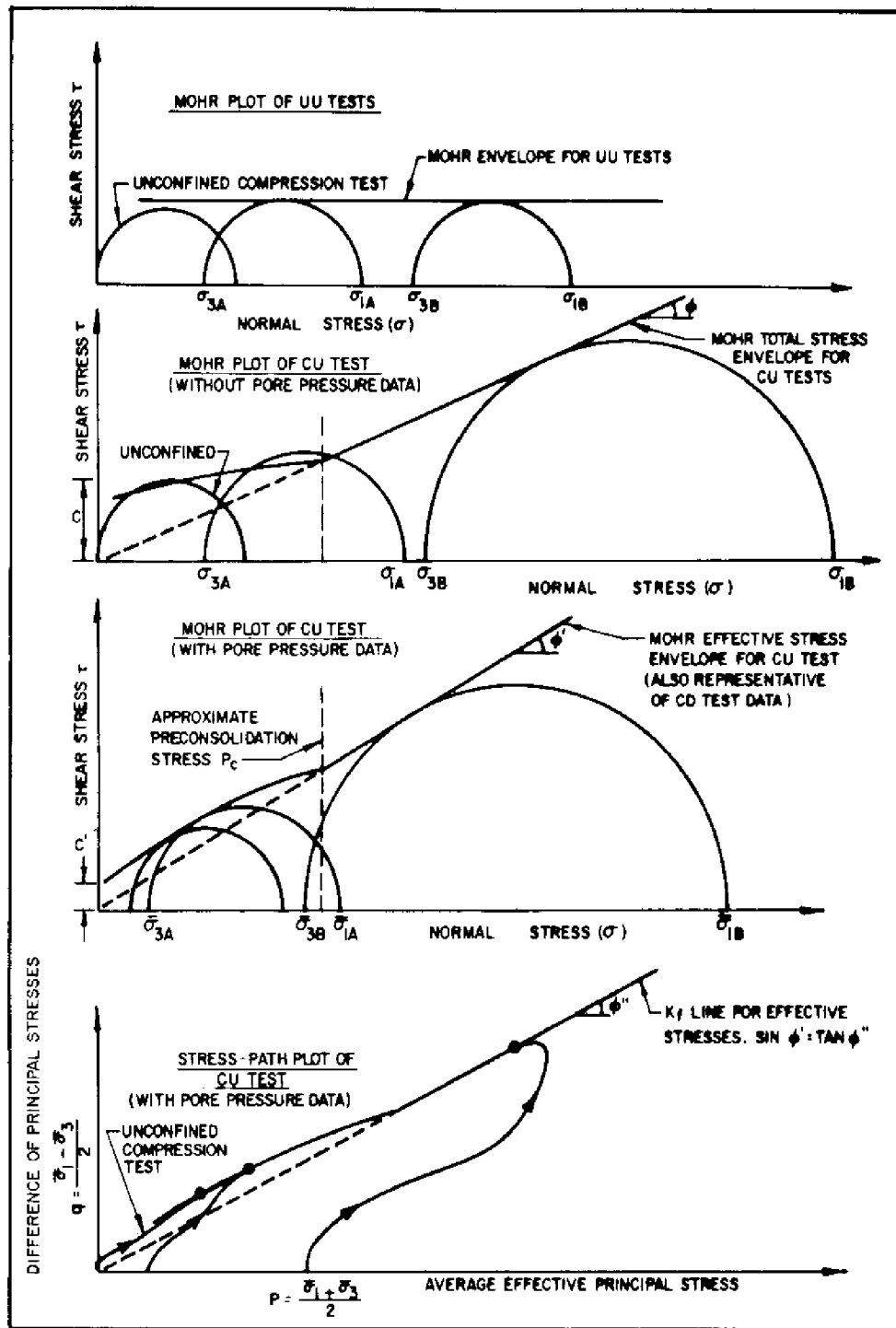

FIGURE 6  
Triaxial Shear Test Relationships

The shear strength of soil as determined in UU tests corresponds to total stress, and is applicable only to situations where little consolidation or drainage can occur during shearing. It is applicable primarily to soils having a permeability less than 10. -3- cm per sec.

(2) Consolidated-Undrained (CU) or R Test. In the CU test, complete consolidation of the test specimen is permitted under the confining pressure, but no drainage is permitted during shear. A minimum of three tests is required to define strength parameters  $c$  and  $[\phi]$ , though four test specimens are preferable with one serving as a check. Specimens must as a general rule be completely saturated before application of the deviator stress. Full saturation is achieved by back pressure. Pore water pressure is measured during the CU test, thus permitting determination of the effective stress parameters  $c'$  and  $[\phi]'$ . In the absence of pore pressure measurements CU tests can provide only total stress values  $c$  and  $[\phi]$ .

(3) Consolidated-Drained (CD) or S Test. In the CD test, complete consolidation of the test specimen is permitted under the confining pressure and drainage is permitted during shear. The rate of strain is controlled to prevent the build-up of pore pressure in the specimen. A minimum of three tests are required for  $c'$  and  $[\phi]'$  determination. CD tests are generally performed on well draining soils. For slow draining soils, several weeks may be required to perform a CD test.

(4) Factors Affecting Tests. Triaxial test results must be appropriately corrected for membrane stiffness, piston friction, and filter drains, whenever applicable. The shear strength of soft sensitive soils is greatly affected by sample disturbance. The laboratory-measured shear strength of disturbed samples will be lower than the in-place strength in the case of UU tests. In the case of CU or CD tests, the strength may be higher because of the consolidation permitted.

d. Other Procedures. In certain instances, more sophisticated tests are warranted. These may include triaxials with zero lateral strain conditions, simple shear tests, and tests inducing anisotropic stress conditions.

3. TEST SELECTION. In determining the type of test to be employed, considerations must be given to soil type and the applications for which the test data is required. (See Chapter 4 for a discussion of total and effective stress concepts.)

a. Soil Type.

(1) Clean Sands and Gravels. Undisturbed samples are very difficult to obtain and test properly, therefore sophisticated shear tests are usually impractical. For simple foundation problems, the angle of internal friction can be satisfactorily approximated by correlation with penetration resistance, relative density, and soil classification (Figure 7). Confirmation of the potential range of the angle of internal friction can be obtained from shear tests on the sample at laboratory densities bracketing conditions anticipated in the field. For earth dam and high embankment work where the soil will be placed under controlled conditions, triaxial compression tests are warranted.

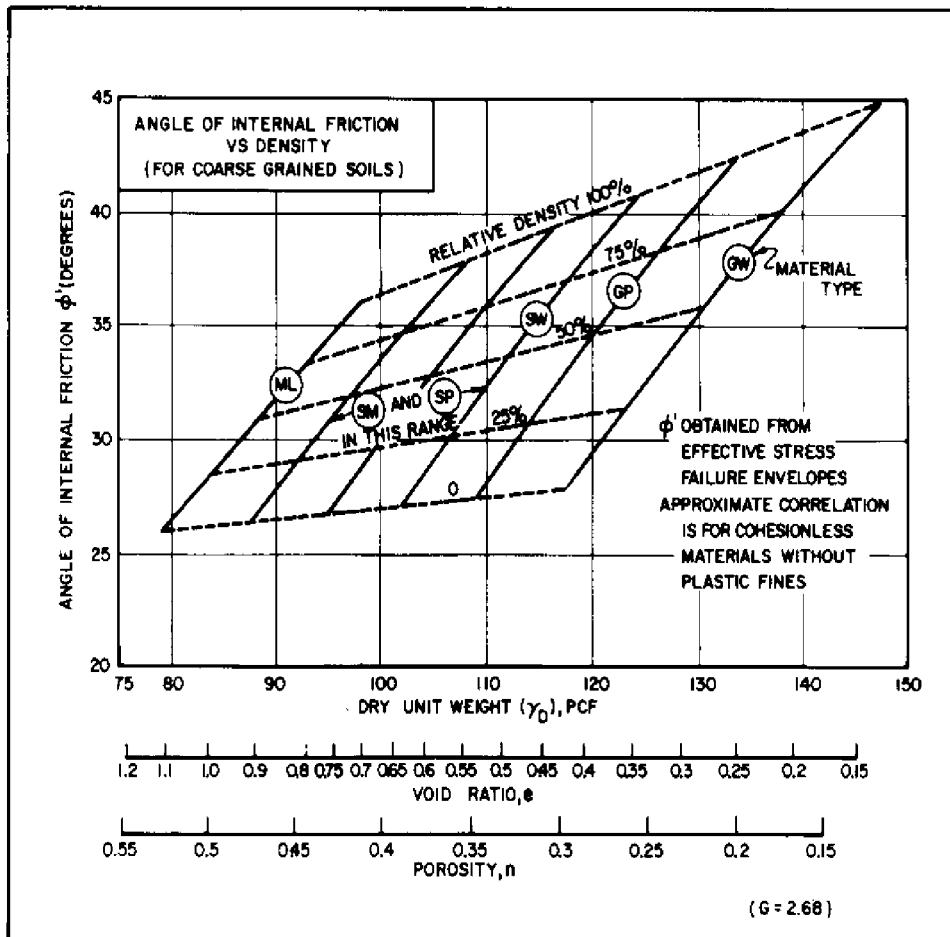

FIGURE 7  
Correlations of Strength Characteristics for Granular Soils



(2) Clays. For simple total stress applications where the immediate stability of foundations or embankments is of concern, the unconfined compression test or UU triaxial test is often adequate (Chapter 1). For very soft or sensitive soils, difficult to sample, the field vane test (Chapter 2) is useful. For long-term stability problems requiring effective stress analysis, such as landslides, CU triaxial tests with pore pressure measurements should be used. Long-term stability problems in some highly overconsolidated clays may require the CD test (see Reference 19, Stability of Natural Slopes and Embankment Foundations State-of-the-Art Report, by Skempton and Hutchinson).

(3) Silts and Mixed Soils. The choice of test is governed by whether total stress analysis or effective stress analysis is applicable. In cases of very soft silts, such as in marine deposits, the in-place vane shear test is especially helpful in evaluating the shear strength and its increase with depth. For some thinly layered soils, such as varved clay, direct shear tests or simple shear tests are well suited for determining the strength of the individual layers. Where partial drainage is anticipated, use CU tests with pore water pressure measurements to obtain effective strength parameters.

(4) Overconsolidated Soils. Frequently overconsolidated soils have defects such as jointing, fissures, etc. The laboratory values of strength which are obtained from a small test specimen are generally higher than the field strength values which are representative of the entire soil mass.

The release of stress due to excavation and exposure to weathering reduces strength over a long period of time. This effect cannot be assessed by any of the laboratory tests currently in use. Most overconsolidated clays are anisotropic and the degree of anisotropy may also be influenced by their age. Effect of anisotropy can be determined in the laboratory.

In highly overconsolidated soil which may not be fully saturated, unusually high back pressure may be necessary to achieve full saturation, thus making it difficult to perform CU tests. CD tests are more appropriate.

b. Type of Application.

(1) Total Stress Analysis. It is appropriate for the immediate (during and end of construction) safety of foundations and structures (embankments) consisting of or resting on clays where permeability is low. It is also applicable to embankment stability where rapid drawdown can occur. Use of unconfined compression tests or UU test is appropriate. Sample disturbance has significant effect on shear strength in these types of tests.

(2) Effective Stress Analysis. Evaluation of long-term stability of slopes, embankments, and earth supporting structures in cohesive soil requires the use of effective stress strength parameters, and therefore CU tests with pore water pressure measurements or CD tests are appropriate. Tests must be run at a slow enough strain rate so that pore pressures are equalized during the CU test or are dissipated throughout the CD test. Essentially all analyses of granular soils are made using effective stress.

(3) Stress Path Method. The stress path method is based on modelling the geological and historical stress conditions as they are known to influence soil behavior. To apply the method, stress history is determined and future stresses are computed based on actual construction plans. The stresses are modelled in a set of triaxial or similar strength tests (see Figure 6). Details of this procedure are found in Reference 20, Stress Path Method, Second Edition, by Lambe and Marr.

## Section 6. DYNAMIC TESTING

1. UTILIZATION. Capabilities of dynamic soil testing methods and their suitability for various motion characteristics are shown in Table 7 (from Reference 10). Dynamic testing is needed for loose granular soils and soft sensitive clays in earthquake areas, for machine foundation design, and for impact loadings. Only a brief description of tests follows. For further guidance on testing procedures, see References 10 and 11.

2. RESONANT COLUMN TEST. The resonant column test consists of the application of sinusoidal vibration to one end (termed the active end) of a solid or hollow cylindrical soil specimen. The other end is known as the passive end. Compression waves or shear waves are propagated through the soil specimen to determine either Young's modulus ( $E_s$ ) or shear modulus ( $G$ ). Moduli are computed from the resonant frequency of the cylinder. For example, in the case where passive end platen is fixed, the lowest frequency for which the excitation force is in phase with the velocity at the active end is termed the resonant frequency. Damping is determined by turning off the excitation at resonant frequency and recording the decaying vibration.

3. CYCLIC TESTS. Currently, these are the most commonly used methods of evaluating the Young's modulus, shear modulus, damping, and liquefaction potential of coarse-grained soils.

a. Cyclic Triaxial Compression Test. In triaxial testing of saturated soils, cell pressure is maintained constant while the axial stress is varied.

b. Cyclic Simple Shear Test. Simple shear equipment has also found wide use in cyclic testing. The non-uniform stress conditions in simple shear may cause failure at a lower stress than that which would cause failure in situ. Measurement or control of lateral pressure is difficult in simple shear tests.

c. Cyclic Torsional Shear. Cyclic torsional simple shear tests on hollow samples offer the capability of measuring lateral confining pressure. In hollow cylinders stresses within the specimen are more uniform, though the specimens are difficult to produce. Also, tapered hollow cylinders have been used in torsional cyclic tests.

TABLE 7  
Capabilities of Dynamic Testing Apparatus

SHEARING STRAIN AMPLITUDE (%)		SHEAR MODULUS G	YOUNGS MODULUS E	DAMP- ING	CYCLIC STRESS BEHAVIOR	ATTENUA- TION
10 <sup>-4</sup>	10 <sup>-3</sup>					
RESONANT COLUMN (SOLID SAMPLE)						
RESONANT COLUMN (HOLLOW SAMPLE)		X	X	X		
ULTRASONIC PULSE		X	X			X
CYCLIC TRIAXIAL			X	X	X	
CYCLIC SIMPLE SHEAR		X		X	X	
TYPICAL MOTION CHARACTERISTICS						
PROPERLY DESIGNED MACHINE		STRONG GROUND SHAKING- EARTHQUAKE		CLOSEIN NUCLEAR EXPLOSION		
10 <sup>-4</sup>	10 <sup>-3</sup>	10 <sup>-2</sup>	10 <sup>-1</sup>	1		

X INDICATE THE PROPERTIES THAT CAN BE DETERMINED.

d. Factors Affecting Tests. Various testing and material factors that may affect cyclic strength as determined in the laboratory are method of specimen preparation, difference between reconstituted and intact specimens, prestressing, loading wave form, grain size and gradation, etc. For details on cyclic testing, see Reference 21, A Review of Factors Affecting Cyclic Triaxial Tests, by Townsend. For the nature of soil behavior under various types of dynamic testing see Reference 22, The Nature of Stress-Strain Behavior for Soils, by Hardin.

4. EMPIRICAL INDICATORS. The empirical relationships given here are to be used only as indicators and not in final design. Design involving dynamic properties of soil must be done only under the direction of experienced personnel.

a. Shear Modulus. In the absence of dynamic tests initial estimates of shear modulus,  $G$ , may be made using the relationships found in Reference 23, Shear Modulus and Damping in Soils: Design Equations and Curves, by Hardin and Drnevich, and Reference 24, Soil Moduli and Damping Factors for Dynamic Response Analyses, by Seed and Idriss.

b. Poisson's Ratio. Values of Poisson's ratio ( $\nu$ ) are generally difficult to establish accurately. For most projects, the value does not affect the response of the structure sufficiently to warrant a great deal of effort in their determination. For cohesionless soils,  $\nu = 0.25$  and for cohesive soils  $\nu = 0.33$  are considered reasonable assumptions. See Reference 25, Foundation Vibration, by Richart.

c. Liquefaction of Coarse-Grained Soils. Liquefaction has usually occurred in relatively uniform material with  $D_{10}$ , ranging between 0.01 and 0.25 mm,  $C_u$ , between 2 and 10, and standard penetration resistance less than 25 blows per foot. Liquefaction is more likely to be triggered by higher velocity than by higher acceleration. These characteristics may be used as a guide in determining the need for dynamic testing. The potential influence of local soil conditions (depth of stratum, depth of groundwater table, variation in soil density, etc.) on shaking and damage intensity must be carefully evaluated. See References 26, Earthquake Effects on Soil Foundation Systems, by Seed, and Reference 27, A Practical Method for Assessing Soil Liquefaction Potential Based on Case Studies at Various Sites in Japan, by Iwasaki, et al. A surcharge reduces the tendency of a deposit to liquefy.

#### Section 7. TESTS ON COMPACTED SOILS

1. UTILIZATION. Compaction is used to densify soils during placement to minimize post-construction consolidation and to improve strength characteristics. Compaction characteristics are determined by moisture density testing; structural and supporting capabilities are evaluated by appropriate tests on samples of compacted soil.

2. MOISTURE-DENSITY RELATIONSHIPS. The Proctor test or a variation is employed in determining the moisture-density relationship. For cohesionless soils, Relative Density methods may be more appropriate.

a. Standard Proctor Test. Use standard Proctor tests for ordinary embankment compaction control. In preparing for control, obtain a family of compaction curves representing principal borrow materials.

b. Modified Proctor Test. Specially applicable to either a heavily compacted base course or a subgrade for airfield pavement and may also be used for mass earthwork.

c. Relative Density of Cohesionless Soils. Proctor tests are often difficult to control for free-draining cohesionless soils and may give erratic compaction curves or density substantially less than those provided by ordinary compaction in the field (see Reference 28, Soil Mechanics, by Lambe and Whitman). Thus, relative density methods may be preferred. Tests for maximum and minimum densities should be done in accordance with ASTM Standard D2049, Relative Density of Cohesionless Soils (Table 3).

3. STRUCTURAL PROPERTIES. Structural properties of compacted-fill materials classified in the Unified System are listed in DM-7.2, Chapter 2, Table 1.

4. CALIFORNIA BEARING RATIO (CBR). This test procedure covers the evaluation of subgrade, subbase, and base course materials for pavement design for highways and airfields. The resistance of a compacted soil to the gradual penetration of a cylindrical piston with 3 square inches in area is measured. The load required to cause either 0.1 inch or 0.2 inch penetration of the piston is compared to that established for a standard compacted crushed stone to obtain the bearing ratio. (See DM-21.03 for approximate relationships between soil type and CBR.) For guidance for design of subbase and bases, see DM-5.04 and DM-21.03.

#### Section 8. TESTS ON ROCK

1. STRUCTURAL TESTS. Standard methods of testing rock in the laboratory for structural characteristics are only for intact rock. See Table 8 for testing procedures. Behavior of in situ rock, which typically has bedding planes, joints, etc., and may contain discontinuities filled with weaker material, is found to be very different from that of intact rock. In situ tests of joint strengths and compressibility are, therefore, more appropriate. See Chapters 1 and 2 for rock and rock joint classifications and in situ measurements of their properties. The use of data from laboratory tests for bearing and settlement calculations of shallow and deep foundations is shown in DM-7.02 Chapters 4 and 5. Factors which correlate intact rock sample parameters to realistic field parameters are RQD (Rock Quality Designation) or the ratios of field values to laboratory values of compression or shear wave velocities (see Chapters 1 and 2).

TABLE 8  
 Test Procedures for Intact Rock

Test	Procedure[(a)]	Size of Sample for Test
Reference for Standard		
Unconfined compressive strength of core specimen	(1, ASTM D2938)	Right circular cylinder with length to diameter ratio of 2 to 2.5, and a diameter not less than 2 inches.
Elastic constants of core specimen	(1, ASTM D3148)	Right circular cylinder with length to diameter ratio of 2 to 2.5.
Direct tensile strength of intact rock core specimen	(1, ASTM D2936)	Right circular cylinder with length to diameter ratio of 2 to 2.5.
Triaxial strength of core specimen	(1, ASTM D2664)	Right circular cylinder with length to diameter ratio of 2 to 2.5.
Dynamic properties of core specimen at small strains	(1, ASTM D2845)	Variable, dependent on properties of specimen and test apparatus.

\*[(a)] Number in parenthesis indicates Reference number.

## 2. ROCK QUALITY TESTS.

a. Standards. Quality is normally evaluated by visual examination of the state of weathering and number and condition of discontinuities. RQD provides the best currently available basis for establishing overall rock quality. See Chapter 1 for additional guidance regarding the evaluation of rock quality using RQD. Relative measurements of rock quality can be made by comparing ratios of field values of compression or shear wave velocities to laboratory values (see Chapters 1 and 2).

b. Aggregate Tests. While intended for roadway construction and asphalt and concrete aggregates, there are several standard tests which provide methods for measuring certain aspects of rock quality (see Table 9).

TABLE 9  
 Test Procedures for Aggregate

Test	Procedure(a)	Applicability to Rock Cores
* Reference for Standard		
* Weathering resistance.	* (1, ASTM C88)	* Applicable in principle, can be used directly by fracturing core.
* Visual evaluation of rock quality.	* (1, ASTM C295)	* Direct.
* Resistance to freezing.	* (1, ASTM C666)	* Applicable in principle; but only with significant procedure changes.
* Hardness.	* (1, ASTM C851)	* Direct.

\*(a) Number in parenthesis indicates Reference number.



## REFERENCES

1. American Society for Testing and Materials, Annual Book of ASTM Standards, Part 19 - Natural Building Stone, Soil and Rock, Peat, Mosses, and Humus; Part 14 - Concrete and Mineral Aggregates; Part 4 - Structural Steel, ASTM, Philadelphia, Pennsylvania.
2. Lambe, T.W., Soil Testing for Engineers, John Wiley, New York, 1951.
3. Bishop, A.W., and Henkel, D.J. The Measurement of Soil Properties in the Triaxial Test, Edward Arnold, Ltd, London, 1962.
4. Office of the Chief of Engineers, Laboratory Soils Testing, Department of the Army, Engineering Manual EM 1110-2-1906, Washington, D.C., 1970.
5. American Society of Agronomy and the American Society for Testing and Materials, Methods of Soil Analysis, Chemical and Microbiological Properties, Part 2, Black, C.A., ed., American Society of Agronomy, Inc., Madison, WI, 1965.
6. National Bureau of Standards, Underground Corrosion, Circular C450, United States Government Printing Office.
7. American Association of State Highway and Transportation Officials, Standard Specifications for Transportation Materials and Methods of Sampling and Testing, Part II, AASHTO, Washington, D.C., 1978.
8. Jennings, J.E. and Knight, K., A Guide to Construction on or with Materials Exhibiting Additional Settlement Due to Collapse of Grain Structures, Sixth Regional Conference for Africa on Soil Mechanics and Foundation Engineering, 1975.
9. Silver, Marshal L., Laboratory Triaxial Testing Procedures to Determine the Cyclic Strength of Soils, prepared under contract to US NRC, (contract No. WRC-E(11-1)-2433), Report No. NUREG-31, 1976.
10. Wood, Richard D., Measurement of Dynamic Soil Properties, ASCE Geotechnical Division Special Conference on Earthquake Engineering and Soil Dynamics, 1978.
11. Drnevich, V.P., Hardin, B.O., and Shippy, D.J., Modulus and Sampling of Soils by the Resonant Column Method, ASTM, STP 654, 1978
12. Stephenson, R.W., Ultrasonic Testing for Determining Dynamic Soil Modulus, ASTM, STP 654, 1978.
13. Bureau of Reclamation, Permeability and Settlement of Soils, Earth Manual, Designation E-13, United States Government Printing Office, 1974.
14. Terzaghi, K. and Peck, R.B., Soil Mechanics in Engineering Practice, 2nd Edition, John Wiley and Sons, New York, 1967.

15. Wissa, A.E.Z., Christian, J.T., Davis, and Heibert, S., Consolidation at Constant Rate of Strain, Journal of Soil Mechanics and Foundation Division, ASCE, Vol. 97, No. SM10, 1971.
16. Lowe, J., New Concepts in Consolidation and Settlement Analysis, Journal of Geotechnical Engineering Division, ASCE, Vol. 101, No. GT6, 1975.
17. Leonards, G.A., Editor, Foundation Engineering, McGraw Hill, 1962.
18. Schmertmann, J.M., The Undisturbed Consolidation of Clay, Transactions, American Society of Civil Engineers, Vol. 120, p 1201, 1955.
19. Skempton, A.W. and Hutchinson, J., Stability of Natural Slopes and Embankment Foundations State-of-the-Art Report, Proceedings, Seventh International Conference on Soil Mechanics and Foundation Engineering, Mexico, 1969.
20. Lambe, T.W. and Marr, A.W., Stress Path Method, Second Edition, Journal of the Geotechnical Engineering Division, ASCE, Vol. 105, No. GT6, 1979.
21. Townsend, F.L., A Review of Factors Affecting Cyclic Triaxial Tests, Dynamic Geotechnical Testing, ASTM, STP 654, pp 356-383, 1978.
22. Hardin, B.O., The Nature of Stress-Strain Behavior for Soils, Earthquake Engineering and Soil Dynamics, Proceedings of the ASCE Geotechnical Engineering Division Specialty Conference, Pasadena, California, pp 3-90, 1978.
23. Hardin, B.O. and Drnevich, V.P., Shear Modulus and Damping in Soils: Design Equations and Curves, Journal of the Soil Mechanics and Foundation Division, ASCE, Vol. 98, No. SM7, 1972.
24. Seed, H.B. and Idriss, I.M., Soil Moduli and Damping Factors for Dynamic Response Analyses, Report No. EERC 70-10, University of California, 1970.
25. Richart, F.E., Foundation Vibration, Foundation Engineering Handbook, H.F. Winterkorn and H.Y. Fang, eds., Van Nostrand Reinhold Company, New York, Chapter 24, 1975.
26. Seed, H.B., Earthquake Effects on Soil Foundation Systems, Foundation Engineering Handbook, H.F. Winterkorn and H.Y. Fang, eds., Van Nostrand Reinhold Company, New York, Chapter 25, 1975.
27. Iwasaki, R., Tatsuoka, F., Tokida, K. and Yasuda, S., A Practical Method for Assessing Soil Liquefaction Potential Based on Case Studies at Various Sites in Japan, Proceedings of the Second International Conference on Microsonation for Safer Construction-Research and Application, Vol. II, San Francisco, pp 885-896, 1978.
28. Lambe, T.W. and Whitman, R.V., Soil Mechanics, John Wiley & Sons, New York, 1969.

29. Naval Facilities Engineering Command, Design Manuals (DM).

DM-5.04	Pavements
DM-21 Series	Airfield Pavement
DM-21.03	Flexible Pavement Design for Airfields

Copies of design manuals may be obtained from the U.S. Naval Publications and Forms Center, 5801 Tabor Avenue, Philadelphia, PA 19120.

CHAPTER 4. DISTRIBUTION OF STRESSES

Section 1. INTRODUCTION

1. SCOPE. This chapter covers the analysis of stress conditions at a point, stresses beneath structures and embankments, and empirical methods for estimating loads on buried pipes, conduits, shafts, and tunnels.

2. RELATED CRITERIA. For certain criteria not covered in this publication, but concerning the design of buried pipes and conduits and other underground structures, see the following sources:

Subject	Source
Airfield Pavements .....	NAVFAC DM-21 Series
Drainage Systems .....	NAVFAC DM-5.03

3. STATE OF STRESS. Stresses in earth masses are analyzed using two basic and different assumptions. One assumes elastic conditions, and the other assumes full mobilization of shear strength (plastic equilibrium). Elastic solutions apply to problems for which shear failure is unlikely. If the safety factor against shear failure exceeds about 3, stresses are roughly equal to values computed from elastic theory. Plastic equilibrium applies in problems of foundation or slope stability (see Chapter 7) and wall pressures where shear strength may be completely mobilized (see DM-7.02, Chapter 3).

Section 2. STRESS CONDITIONS AT A POINT

1. MOHR'S CIRCLE OF STRESS. If normal and shear stresses at one orientation on an element in an earth mass are known, stresses at all other orientations may be determined from Mohr's circle. Examples of stress transformation are given in Figure 1.

a. Plastic Equilibrium. The use of Mohr's circle for plastic equilibrium is illustrated by analysis of triaxial shear test results (see Figure 5 of Chapter 3).

2. STRESSES IN SOILS. The normal stress at any orientation in a saturated soil mass equals the sum of two elements: (a) pore water pressure carried by fluid in soil spaces, and (b) effective stress carried by the grain skeleton of the soil.

a. Total Stress. The total stress at any point is produced by the overburden pressure plus any applied loads.

b. Pore Water Pressure. Pore water pressure may consist of (a) hydrostatic pressure, (b) capillary pressure, (c) seepage or (d) pressure resulting from applied loads to soils which drain slowly.

c. Effective Stress. Effective stress equals the total stress minus the pore water pressure, or the total force in the soil grains divided by the gross cross-sectional area over which the force acts.

d. Overburden Pressure. Division of weight of overlying soil and water into effective stress and pore water pressure depends on the position of the groundwater table or the flow field induced by seepage. For static water condition, effective stresses at any point below the groundwater level may be computed using the total unit weight of soil above the water level and buoyant unit weight below the water level. Pore water pressure is equal to the static head times the unit weight of water. If there is steady seepage, pore pressure is equal to the piezometric head times the unit weight of water, and the effective stress is obtained by subtracting the pore water pressure from the total stress.

e. Applied Load. Division of applied load between pore pressure and effective stress is a function of the boundary conditions, the stress-strain properties, and the permeability of the stressed and surrounding soils. When drainage of pore water is inhibited, load is compensated for by increased pore water pressures. These pressures may decrease with time, as pore water is drained and load is transferred to the soil skeleton, thereby increasing effective stress. Guidance on estimating changes in pore water pressure is given in Chapter 5.

f. Effects of Stresses on a Soil Mass. Analysis of a soil system (e.g., settlement, stability analyses) are performed either in terms of total stresses or effective stresses. The choice between the two analysis methods is governed by the properties of the surrounding soils, pore water behavior, and the method of loading. (See Chapters 5, 6, and 7 for further discussion.)

### Section 3. STRESSES BENEATH STRUCTURES AND EMBANKMENTS

#### 1. SEMI-INFINITE, ELASTIC FOUNDATIONS.

a. Assumed Conditions. The following solutions assume elasticity, continuity, static equilibrium, and completely flexible loads so that the pressures on the foundation surface are equal to the applied load intensity. For loads of infinite length or where the length is at least 5 times the width, the stress distribution can be considered plane strain, i.e., deformation occurs only in planes perpendicular to the long axis of the load. In this case stresses depend only on direction and intensity of load and the location of points being investigated and are not affected by elastic properties.

Shearing stresses between an embankment and its foundation are neglected.

b. Stress Distribution Formulas. Figure 2 presents formulas based on the Boussinesq equations for subsurface stresses produced by surface loads on semi-infinite, elastic, isotropic, homogeneous foundations. Below a depth of

three times the width of a square footing or the diameter of a circular footing, the stresses can be approximated by considering the footing to be a point load. A strip load may also be treated as a line load at depths greater than three times the width of the strip.

c. Vertical Stresses Beneath Regular Loads. Charts for computations of vertical stress based on the Boussinesq equations are presented in Figures 3 through 7. Use of the influence charts is explained by examples in Figure 8. Computation procedures for common loading situations are as follows:

(1) Square and Strip Foundations. Quick estimates may be obtained from the stress contours of Figure 3. For more accurate computations, use Figure 4 (Reference 1, Stresses and Deflections in Foundations and Pavements, by the Department of Civil Engineering, University of California, Berkeley).

(2) Rectangular Mat Foundation. For points beneath the mat, divide the mat into four rectangles with their common corner above the point to be investigated. Obtain influence values  $I$  for the individual rectangles from Figure 4, and sum the values to obtain the total  $I$ . For points outside the area covered by the mat, use superposition of rectangles and add or subtract appropriate  $I$  values to obtain the resultant  $I$ . (See example in Figure 9.)

(3) Uniformly Loaded Circular Area. Use Figure 5 (Reference 2, Stresses and Deflections Induced by Uniform Circular Load, by Foster and Ahlvin) to compute stresses under circular footings.

(4) Embankment of Infinite Length. Use Figure 6 (Reference 3, Influence Values for Vertical Stresses in a Semi-Infinite Mass Due to an Embankment Loading, by Osterberg) for embankments of simple cross section. For fills of more complicated cross section, add or subtract portions of this basic embankment load. For a symmetrical triangular fill, set dimension  $b$  equal to zero and add the influence values for two right triangles.

(5) Sloping Fill of Finite Dimension. Use Figure 7 (Reference 1) for stress beneath the corners of a finite sloping fill load.

d. Vertical Stresses Beneath Irregular Loads. Use Figure 10 (Reference 4, Soil Pressure Computations: A Modification of Newmark's Method, by Jimenez Salas) for complex loads where other influence diagrams do not suffice. Proceed as follows:

(1) Draw a circle of convenient scale and the concentric circles shown within it. The scale for the circle may be selected so that when the foundation plan is drawn using a standard scale (say 1"=100'), it will lie within the outer circle.

(2) Plot the loaded area to scale on this target with the point to be investigated at the center.

(3) Estimate the proportion  $A$  of the annular area between adjacent radii which is covered by the load.

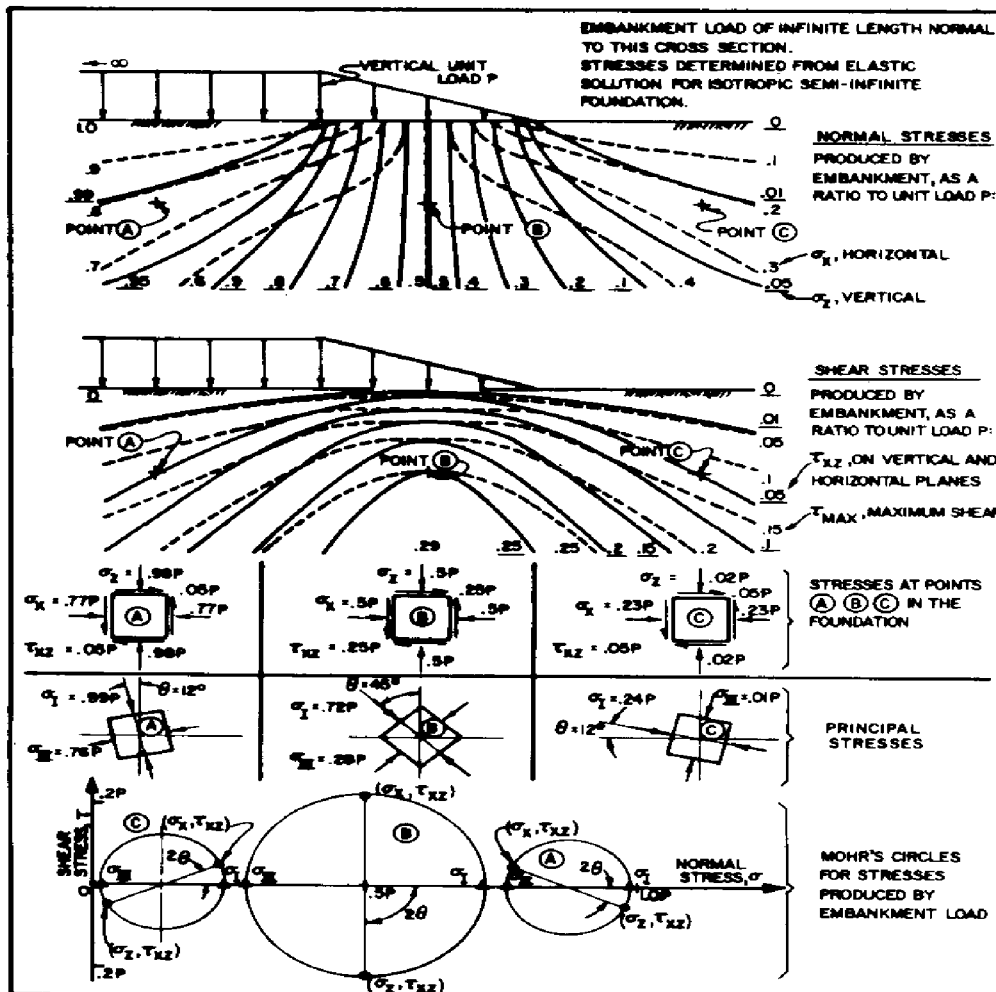

FIGURE 1  
Examples of Stress Conditions at a Point

LOADING CONDITION	STRESS DIAGRAM	STRESS COMPONENT	EQUATION
POINT LOAD		VERTICAL	$\sigma_z = -\frac{P}{2\pi R^2} \left[ \frac{3z^2}{R^3} + \frac{(1-2\mu)R}{R+z} \right]$
		HORIZONTAL	$\sigma_r = \frac{P}{2\pi} \left[ \frac{z^2}{R^3} - (1-2\mu) \frac{R-z}{R^2} \right]$
		SHEAR	$\tau_{rz} = \frac{3P}{2\pi} \cdot \frac{rz}{R^3}$
UNIFORM LINE LOAD OF INFINITE LENGTH		VERTICAL	$\sigma_z = \frac{2p}{\pi} \cdot \frac{z^3}{R^4}$
		HORIZONTAL	$\sigma_r = \frac{2p}{\pi} \cdot \frac{x^2 z}{R^4}$
		SHEAR	$\tau_{xz} = \frac{2p}{\pi} \cdot \frac{xz^2}{R^4}$
UNIFORMLY LOADED RECTANGULAR AREA (FIGURE 4)		VERTICAL (BENEATH CORNER OF RECTANGLE)	$\sigma_z = \frac{p}{4\pi} \left[ \frac{2XYZ(X^2+Y^2+Z^2)\sqrt{Z}}{Z^2(X^2+Y^2+Z^2)\sqrt{X^2+Y^2+Z^2}} \cdot \frac{X^2+Y^2+2Z^2}{X^2+Y^2+Z^2} \right. \\ \left. + \text{TAN}^{-1} \frac{2XYZ(X^2+Y^2+Z^2)\sqrt{Z}}{Z^2(X^2+Y^2+Z^2)-X^2Y^2} \right]$
		VERTICAL	$\sigma_z = p \left[ 1 - \frac{1}{(1+(Z/R)^2)^{3/2}} \right]$
		HORIZONTAL	$\sigma_r = \frac{p}{2} \left[ 1 + 2\mu - 2(1+\mu) \left( \frac{Z}{\sqrt{R^2+Z^2}} + \left( \frac{Z}{\sqrt{R^2+Z^2}} \right)^3 \right) \right]$
		SHEAR	$\tau_{rz} = 0$ (STRESS COMPONENTS $\sigma_z, \sigma_r, \tau_{rz}$ BENEATH CENTER OF CIRCLE)
IRREGULAR LOAD		VERTICAL	COMPUTED FROM INFLUENCE CHART OF FIGURE 10

ASSUMED CONDITIONS APPLIED LOADS ARE PERFECTLY FLEXIBLE. FOUNDATION IS SEMI-INFINITE ELASTIC ISOTROPIC SOLID.

FIGURE 2  
Formulas for Stresses in Semi-Infinite Elastic Foundation



LOADING CONDITION	STRESS DIAGRAM	STRESS COMPONENT	EQUATION
UNIFORM STRIP LOAD		VERTICAL	$\sigma_z = \frac{P}{\gamma} [\alpha + \sin \alpha \cdot \cos(\alpha + 2\gamma)]$
		HORIZONTAL	$\sigma_x = \frac{P}{\gamma} [\alpha - \sin \alpha \cdot \cos(\alpha + 2\gamma)]$
		SHEAR	$\tau_{xz} = \frac{P}{\gamma} [\sin \alpha \cdot \sin(\alpha + 2\gamma)]$
TRIANGULAR LOAD		VERTICAL	$\sigma_z = \frac{P}{\gamma} \left[ \frac{z}{a} \cdot \alpha + \frac{a+b \cdot x}{b} \cdot \beta \right]$
		HORIZONTAL	$\sigma_x = \frac{P}{\gamma} \left[ \frac{z}{a} \cdot \alpha + \frac{a+b \cdot x}{b} \cdot \beta + \frac{2z}{a} \cdot \log_0 \frac{R_1}{R_0} + \frac{2z}{b} \cdot \log_0 \frac{R_2}{R_1} \right]$
		SHEAR	$\tau_{xz} = \frac{Pz}{\gamma} \left[ \frac{\alpha}{a} - \frac{\beta}{b} \right]$
SLOPE LOAD		VERTICAL	$\sigma_z = \frac{P_h}{\gamma_0} [X\beta + z]$
		HORIZONTAL	$\sigma_x = \frac{P_h}{\gamma_0} [X\beta - z - 2z \log_0 R]$
		SHEAR	$\tau_{xz} = \frac{P_h}{\gamma_0} z \beta$
TERRACE LOAD		VERTICAL	$\sigma_z = \frac{P}{\gamma_0} [\alpha \beta + X\alpha]$
		HORIZONTAL	$\sigma_x = \frac{P}{\gamma_0} [\alpha \beta + X\alpha + 2z \log_0 \frac{R_2}{R_1}]$
		SHEAR	$\tau_{xz} = \frac{P}{\gamma_0} \cdot z \alpha$
SEMI-INFINITE UNIFORM LOAD		VERTICAL	$\sigma_z = \frac{P}{\gamma} \left[ \beta + \frac{Xz}{R} \right]$
		HORIZONTAL	$\sigma_x = \frac{P}{\gamma} \left[ \beta - \frac{Xz}{R} \right]$
		SHEAR	$\tau_{xz} = \frac{P}{\gamma} \cdot \sin^2 \beta$
ASSUMED CONDITIONS: APPLIED LOADS ARE PERFECTLY FLEXIBLE. FOUNDATION IS SEMI-INFINITE ELASTIC ISOTROPIC SOLID.			

EMBANKMENT LOADS OF INFINITE LENGTH

FIGURE 2 (continued)  
Formulas for Stresses in Semi-Infinite Elastic Foundation

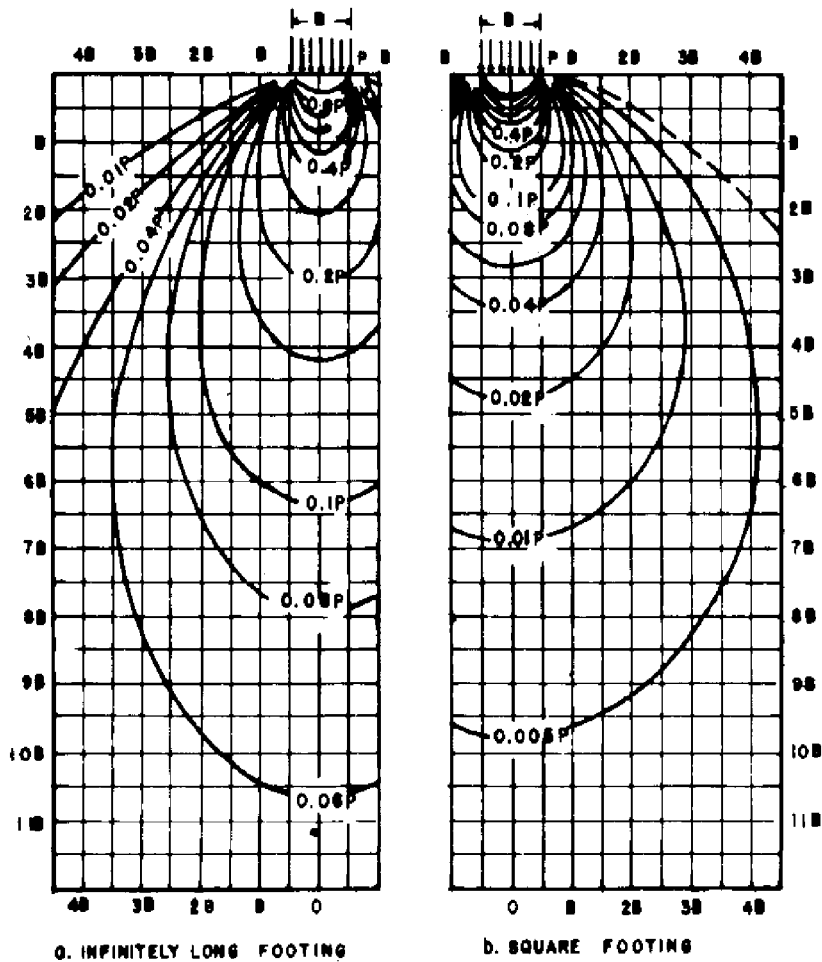

$B = 20'$        $P = 2 \text{ TSF}$

**SQUARE FOOTING**

**GIVEN**

FOOTING SIZE = 20' x 20'  
UNIT PRESSURE  $P = 2 \text{ TSF}$

**FIND**

PROFILE OF STRESS INCREASE  
BENEATH CENTER OF FOOTING  
DUE TO APPLIED LOAD

$z$ (FT)	$\frac{z}{B}$	$\sigma_z$ TSF
10	0.5	$0.70 \times 2 = 1.4$
20	1	$0.38 \times 2 = 0.76$
30	1.5	$0.19 \times 2 = 0.38$
40	2.0	$0.12 \times 2 = 0.24$
50	2.5	$0.07 \times 2 = 0.14$
60	3.0	$0.05 \times 2 = 0.10$

FIGURE 3  
Stress Contours and Their Application

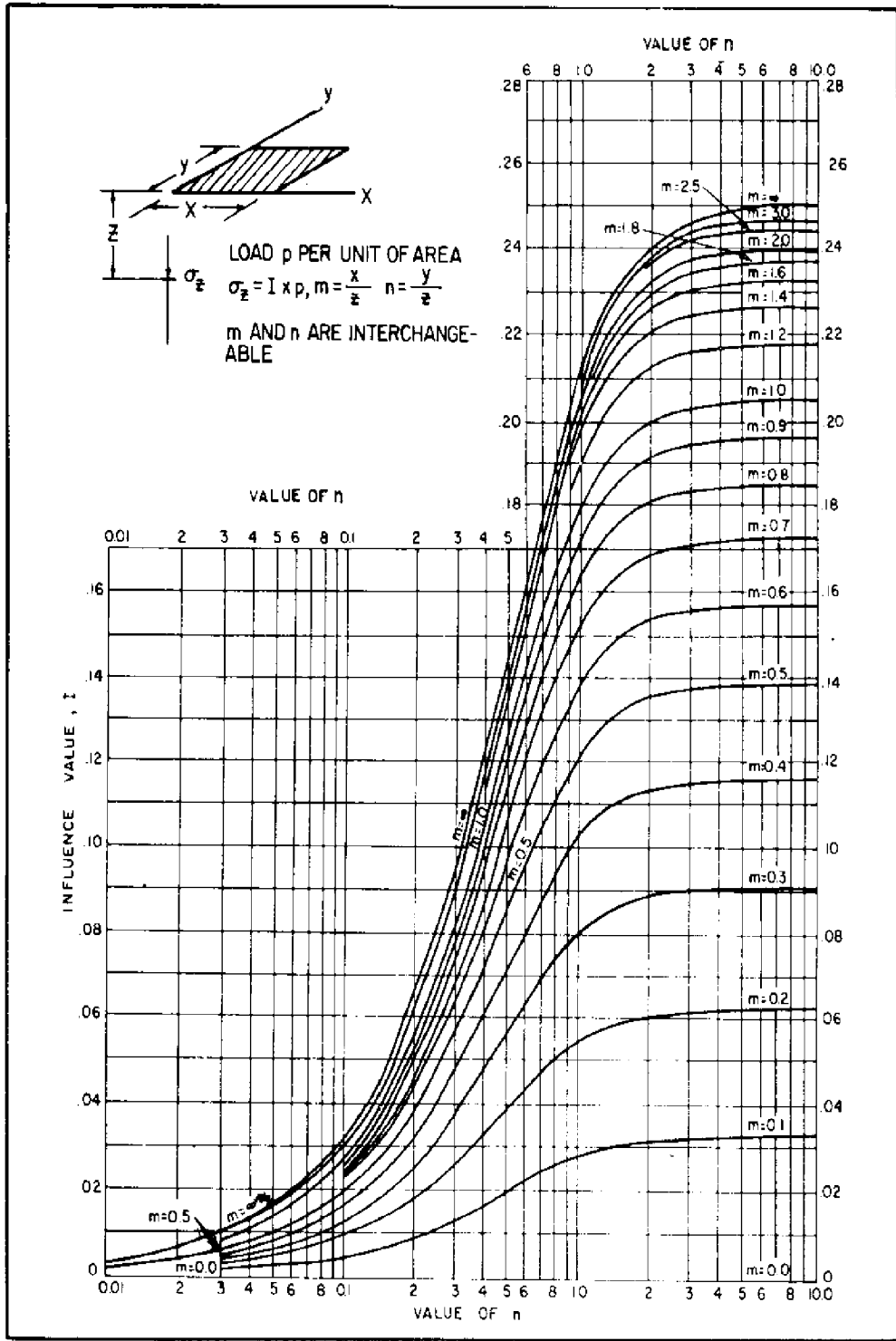

FIGURE 4  
 Influence Value for Vertical Stress Beneath a Corner of a  
 Uniformly Loaded Rectangular Area (Boussinesq Case)

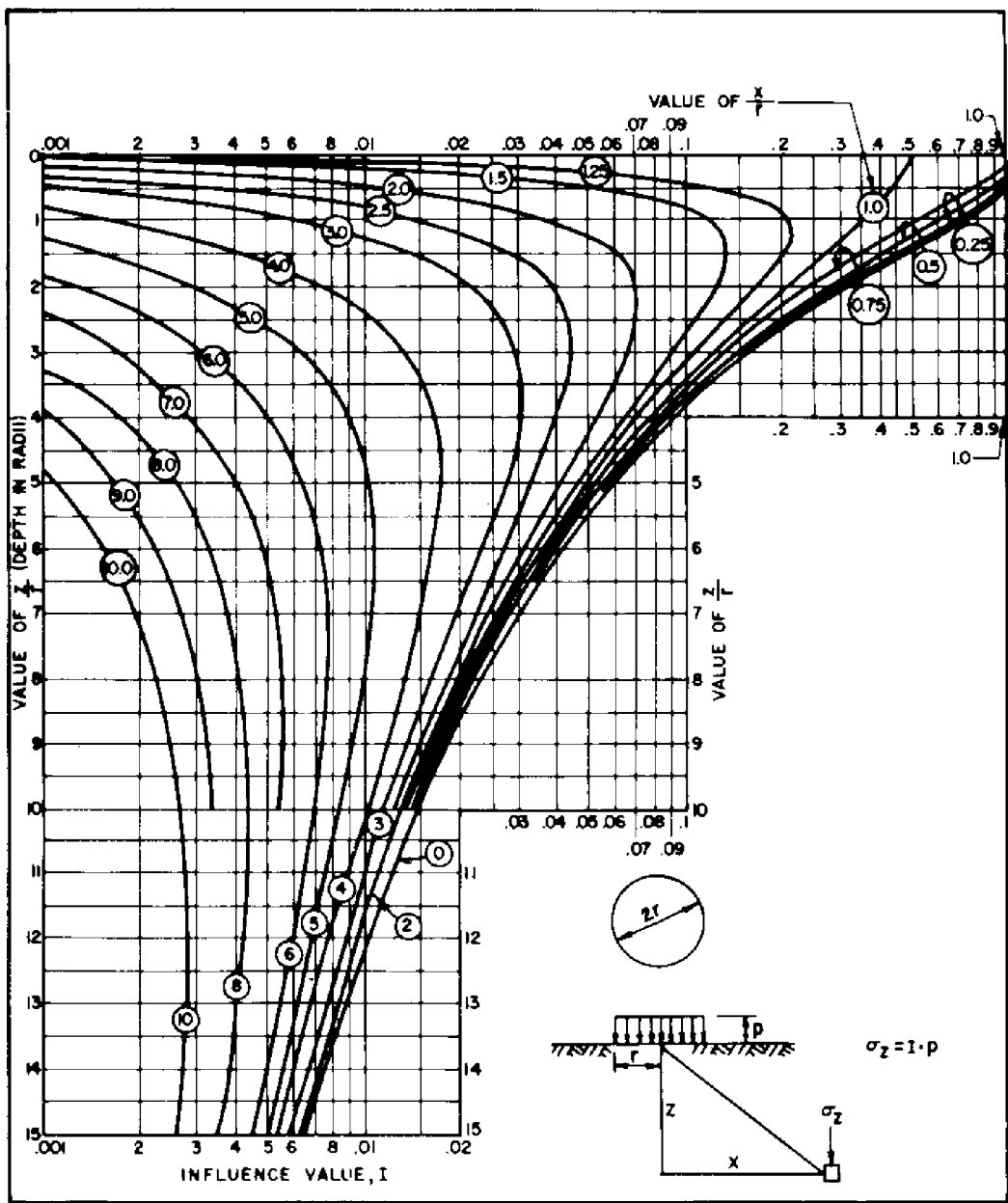

FIGURE 5  
 Influence Value for Vertical Stress Under Uniformly Loaded Circular Area  
 (Boussinesq Case)

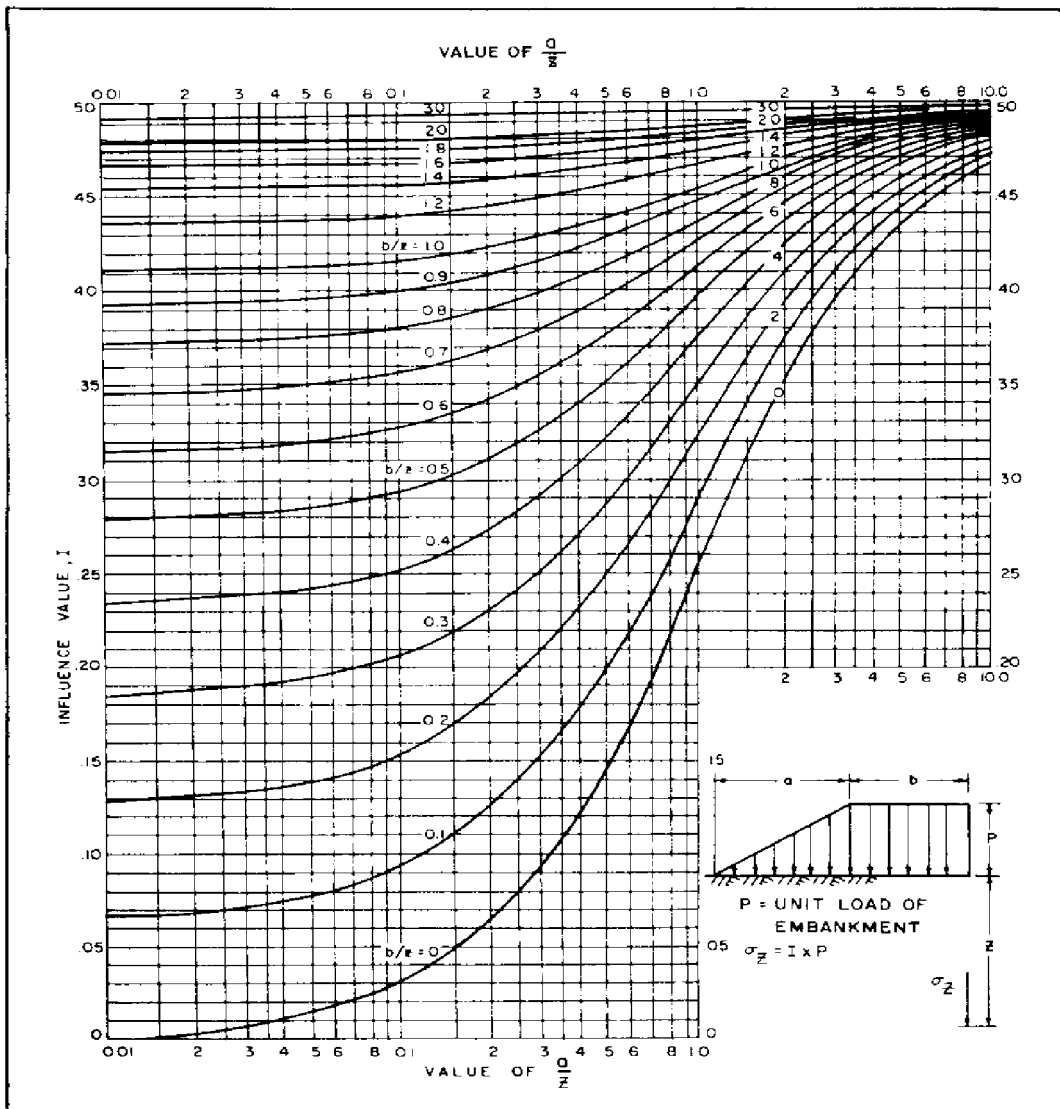

FIGURE 6  
Influence Value for Vertical Stress Under Embankment Load of Infinite Length  
(Boussinesq Case)

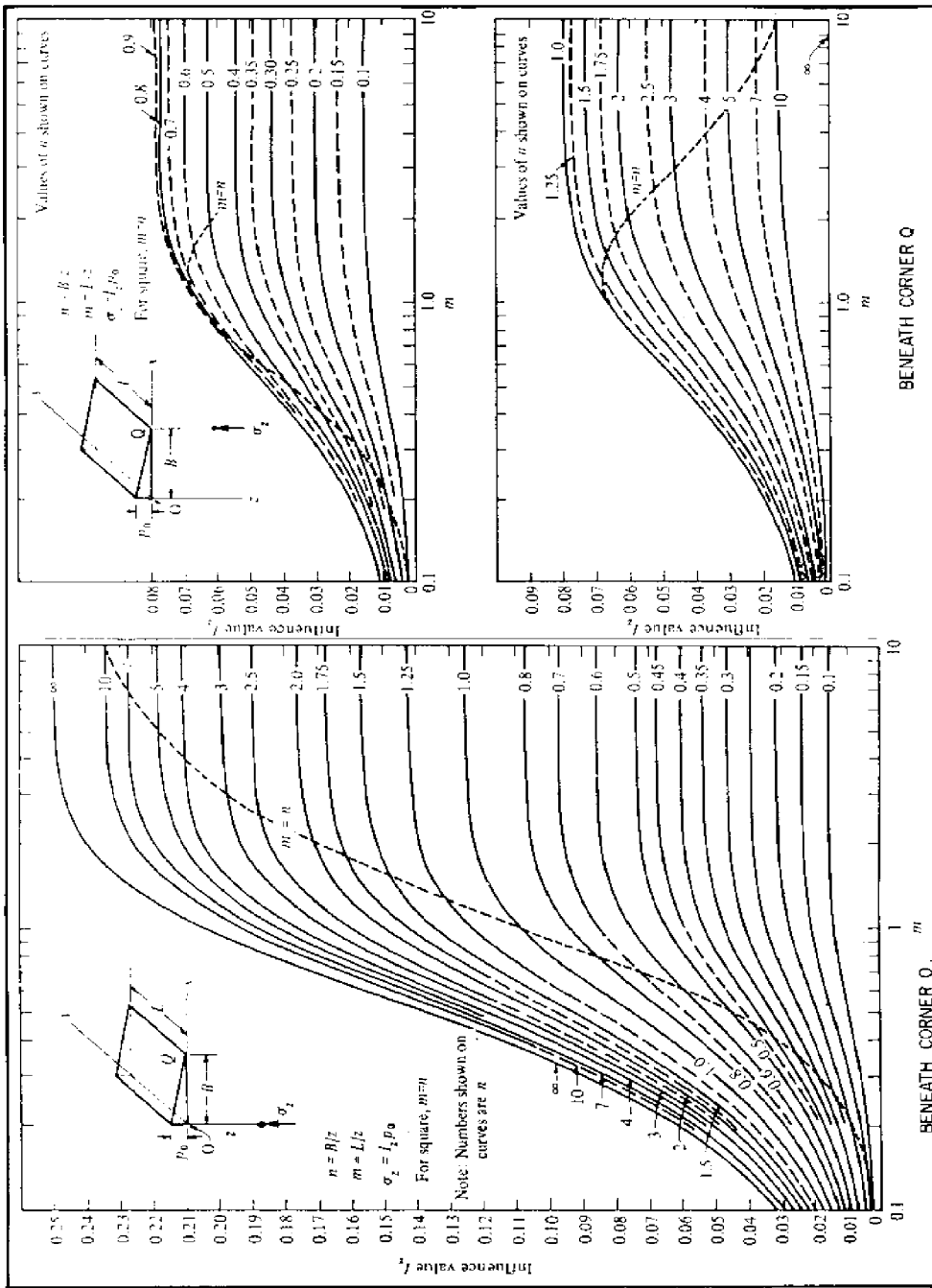

FIGURE 7  
Influence Value for Vertical Stress Beneath Triangular Load  
(Boussinesq Case)

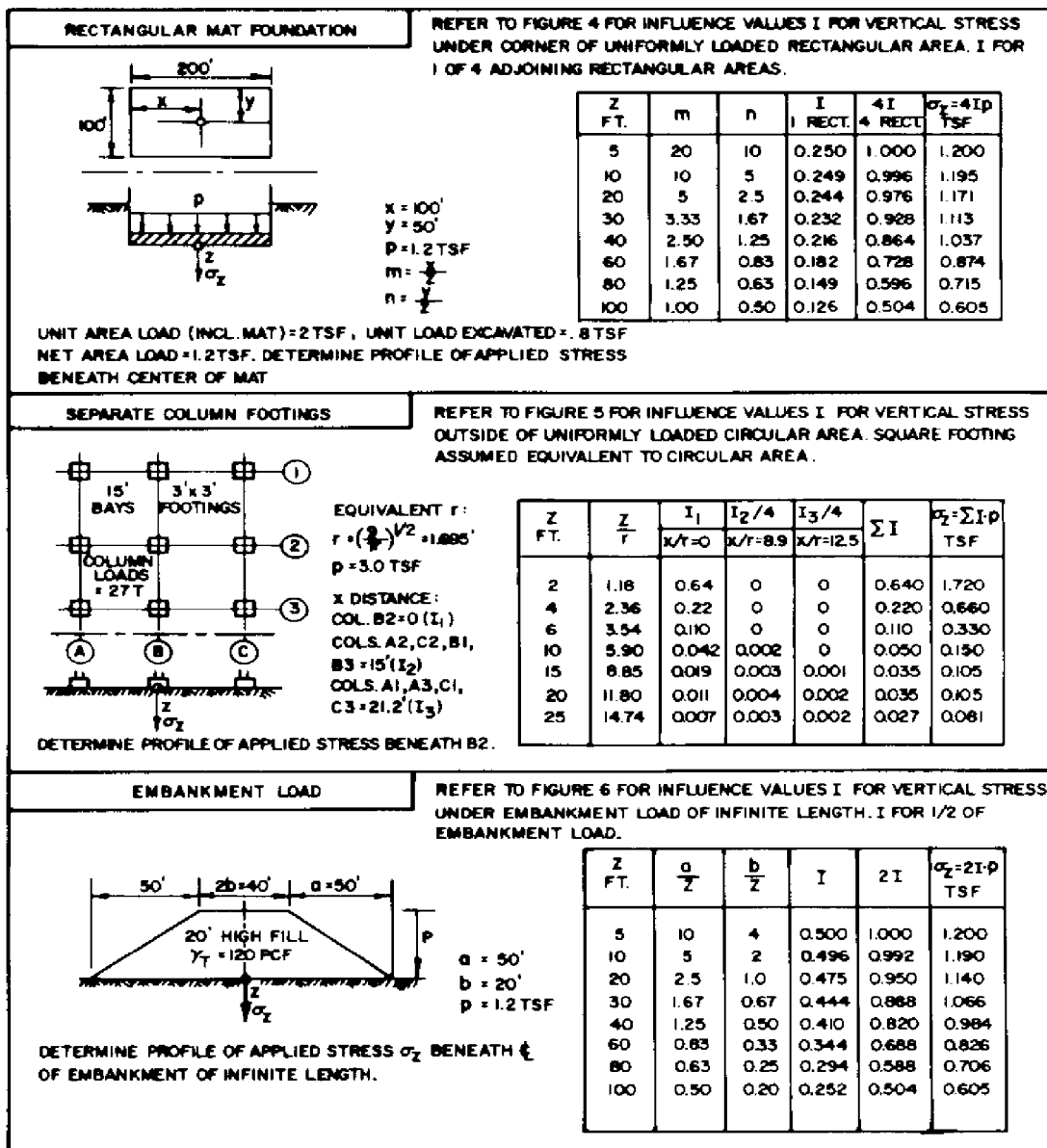

FIGURE 8  
Examples of Computation of Vertical Stress

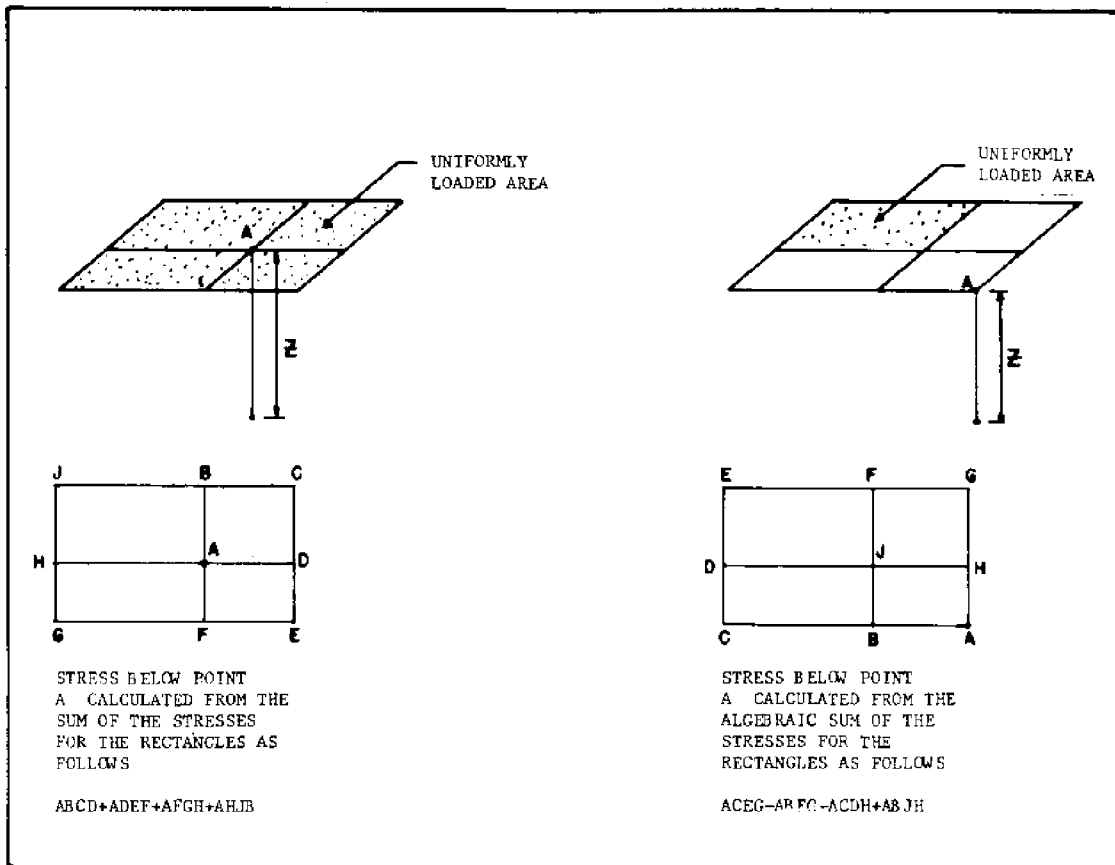

FIGURE 9  
 Determination of Stress Below Corner of  
 Uniformly Loaded Rectangular Area



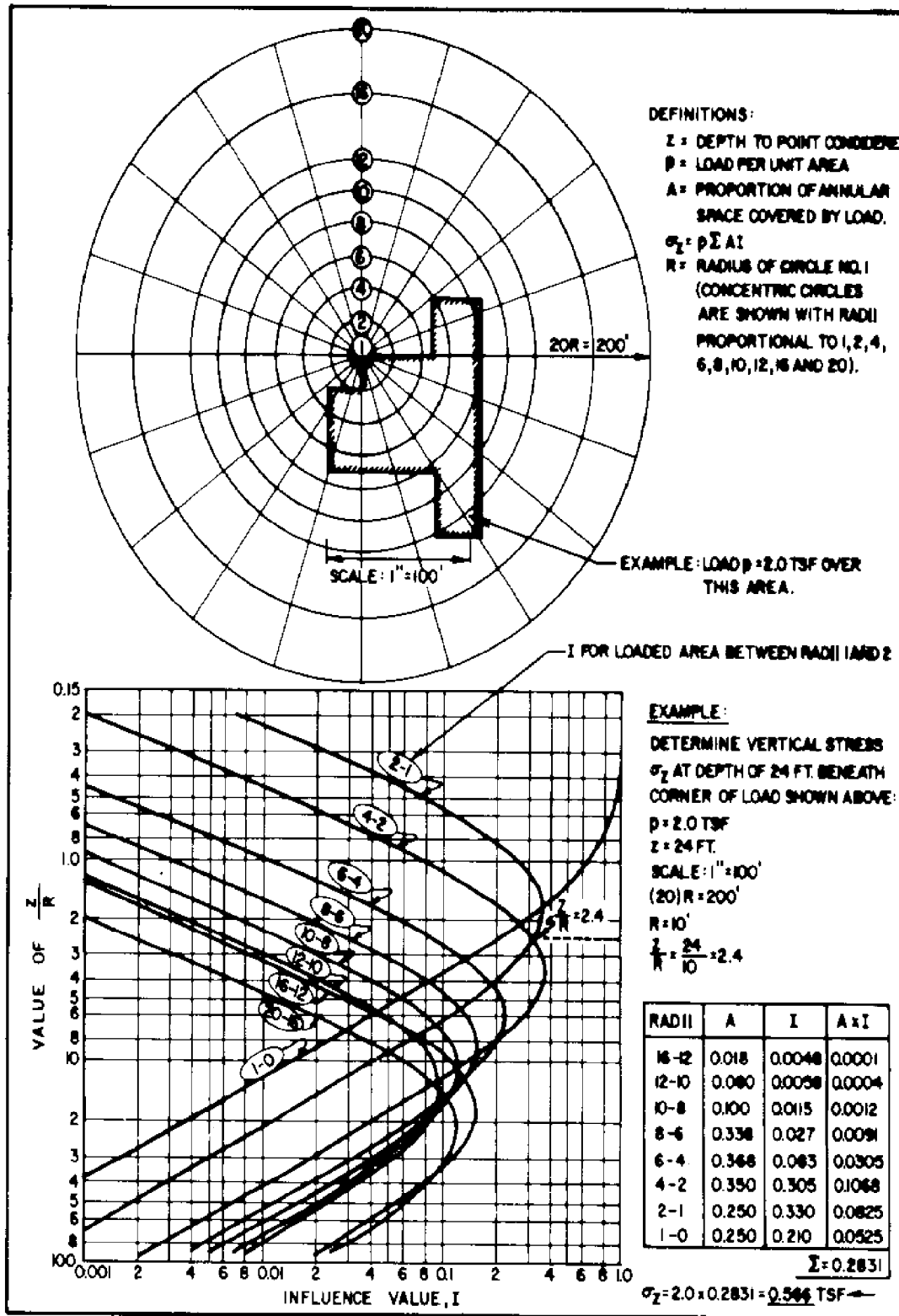

FIGURE 10  
 Influence Chart for Vertical Stress Beneath Irregular Load

(4) See the bottom chart of Figure 10 for influence values for stresses at various depths produced by the loads within each annular space. The product  $I \times A$  multiplied by the load intensity equals vertical stress.

(5) To determine a profile of vertical stresses for various depths beneath a point, the target need not be redrawn. Obtain influence values for different ordinates Z/R from the influence chart.

e. Horizontal Stresses. Elastic analysis is utilized to determine horizontal stresses on unyielding walls from surcharge loads (see Chapter 7.02, Chapter 3), and pressures on rigid buried structures. (See basic formulas for simple loads in Figure 2.) For more information, see Reference 5, Elastic Solutions for Soil and Rock Mechanics, by Poulos and Davis.

f. Shear Stresses. Elastic solutions generally are not applicable when shear stresses are critical, as in stability problems. To determine if a stability analysis is required, determine the maximum shear stress from elastic formulas and compare this stress with the shear strength of the soil. For embankment loads in Figure 2, maximum shear stress in the foundation is exactly or approximately equal to  $p/[\pi]$  depending upon the shape of the load and point in question. If the maximum shear stress equals shear strength, plastic conditions prevail at some point in the foundation soil and if the load is increased, a larger and larger portion of the foundation soil passes into plastic equilibrium. In this case, failure is possible and overall stability must be evaluated.

2. LAYERED OR ANISOTROPIC FOUNDATIONS. Actual foundation conditions differ from the homogeneous isotropic, semi-infinite mass assumed in the Boussinesq expressions. The modulus of elasticity usually varies from layer to layer, and soil deposits frequently are more rigid in the horizontal direction than in the vertical.

a. Westergaard Analysis. The Westergaard analysis is based on the assumption that the soil on which load is applied is reinforced by closely spaced horizontal layers which prevent horizontal displacement. The effect of the Westergaard assumption is to reduce the stresses substantially below those obtained by the Boussinesq equations. The Westergaard analysis is applicable to soil profiles consisting of alternate layers of soft and stiff materials, such as soft clays with frequent horizontal layers of sand having greater stiffness in the horizontal direction. Figures 11 (Reference 1), 12 (Reference 6, An Engineering Manual for Settlement Studies, by Duncan and Buchignani), and 13 (Reference 1) can be used for calculating vertical stresses in Westergaard material for three loading conditions. Computations for Figures 11, 12, and 13 are made in a manner identical to that for Figures 3, 4, and 7, which are based on the Boussinesq equations. For illustration see Figure 8.

b. Layered Foundations. When the foundation soil consists of a number of layers of substantial thickness, having distinctly different elastic properties, the vertical and other stresses are markedly different from those obtained by using the Boussinesq equation. (See Figure 14, Reference 7, Stresses and Displacement in Layered Systems, by Mehta and Veletsos, for influence values of vertical stresses in a two-layer foundation with various ratios of modulus of elasticity. See Figure 15 for an example.)

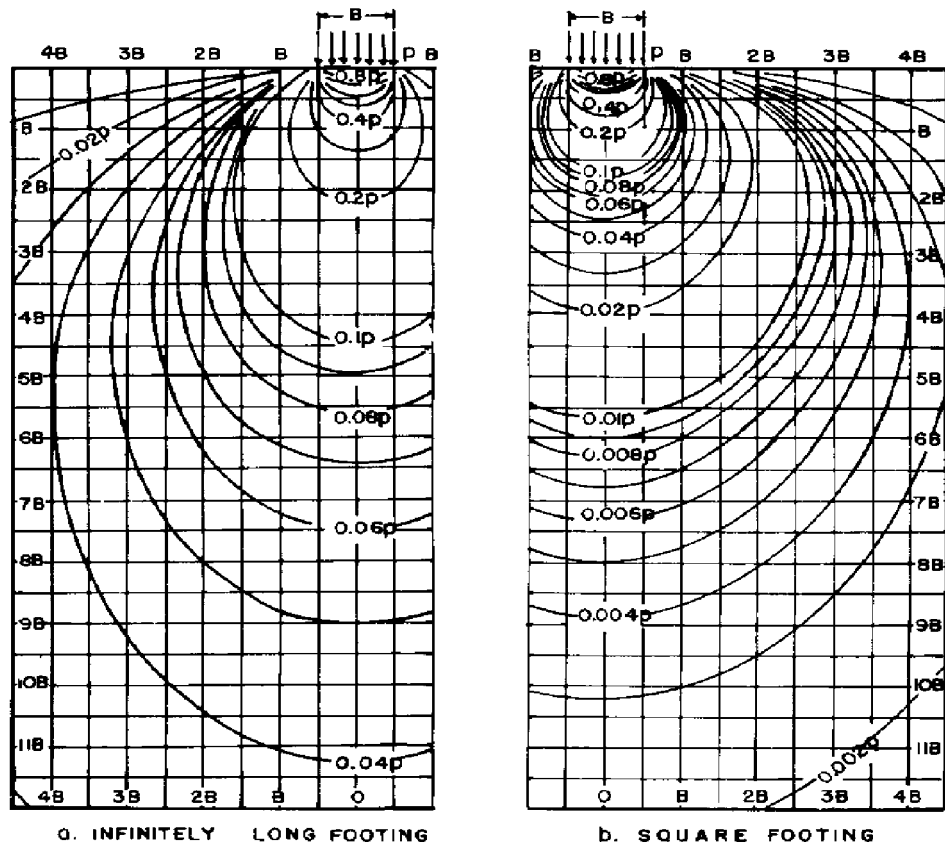

**EXAMPLE:**

FIND THE PRESSURE INCREASE DUE TO A STRIP FOOTING OF WIDTH  $B$ , AT A POINT LOCATED  $6B$  BELOW ITS BASE AND  $3B$  FROM THE CENTER OF THE FOOTING. SURFACE LOAD ON THE FOOTING IS  $P$  PER-UNIT AREA. FROM THE LEFT PANEL, PRESSURE INCREASE =  $0.05 P$

FIGURE 11  
Vertical Stress Contours for Square and Strip Footings  
(Westergaard Case)

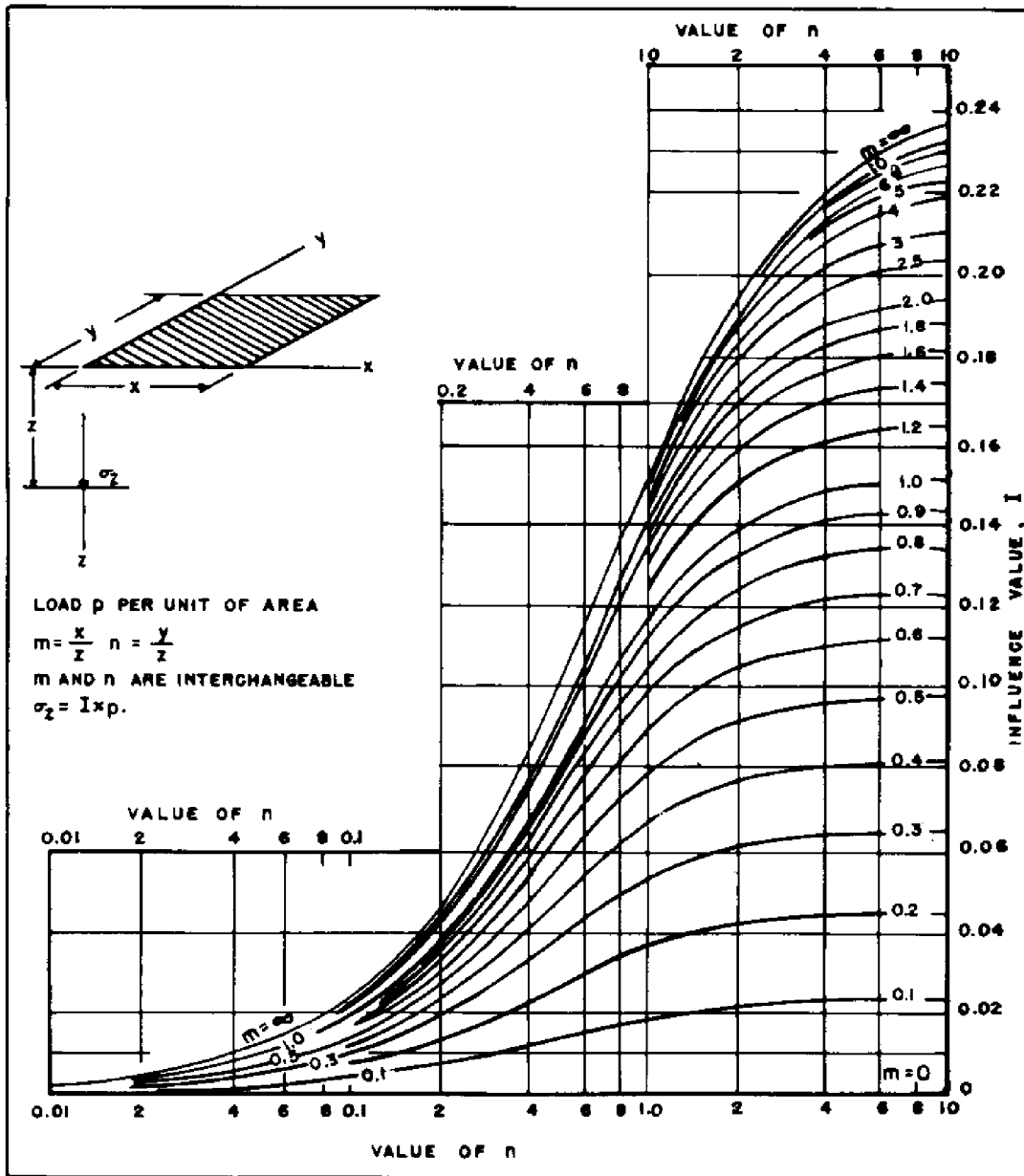

FIGURE 12  
 Influence Value for Vertical Stress Beneath a Corner of a  
 Uniformly Loaded Rectangular Area (Westergaard Case)

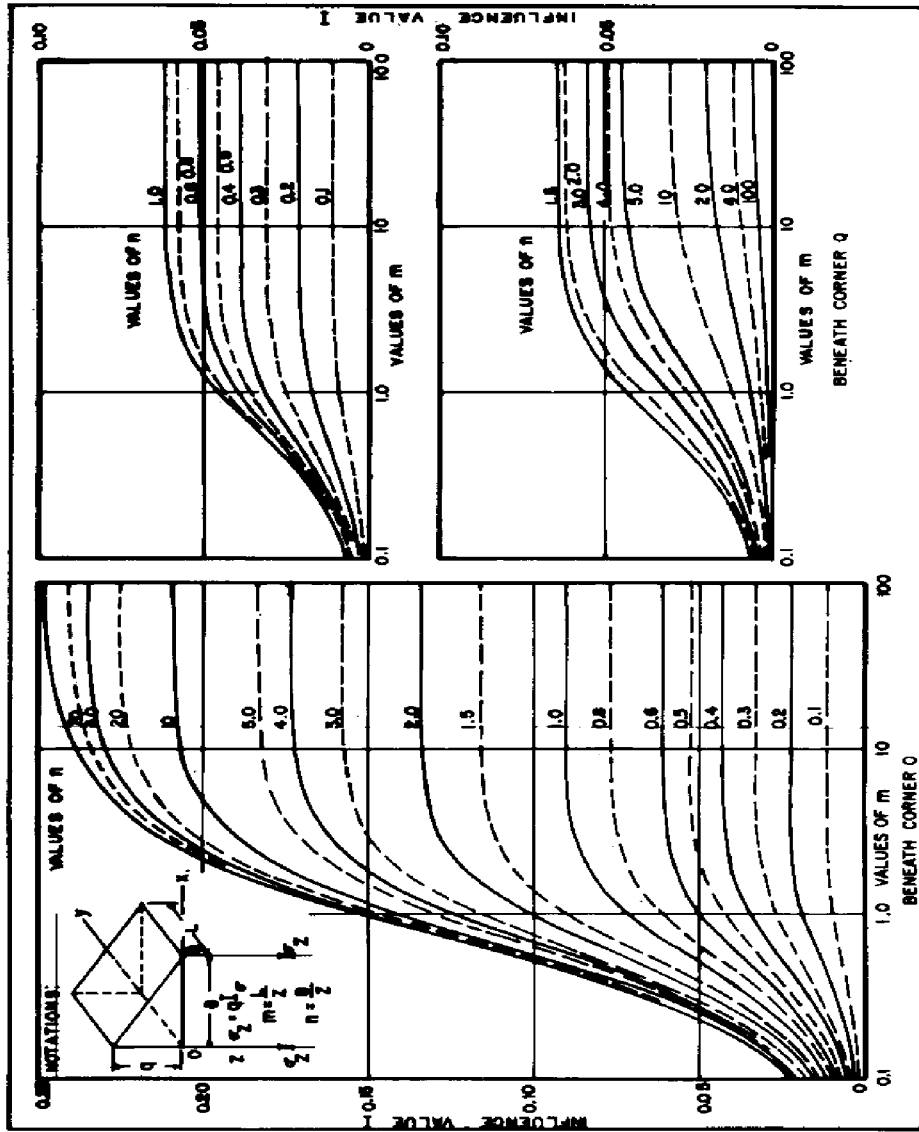

FIGURE 13  
Influence Value for Vertical Stress Beneath Triangular Load  
(Westergaard Case)

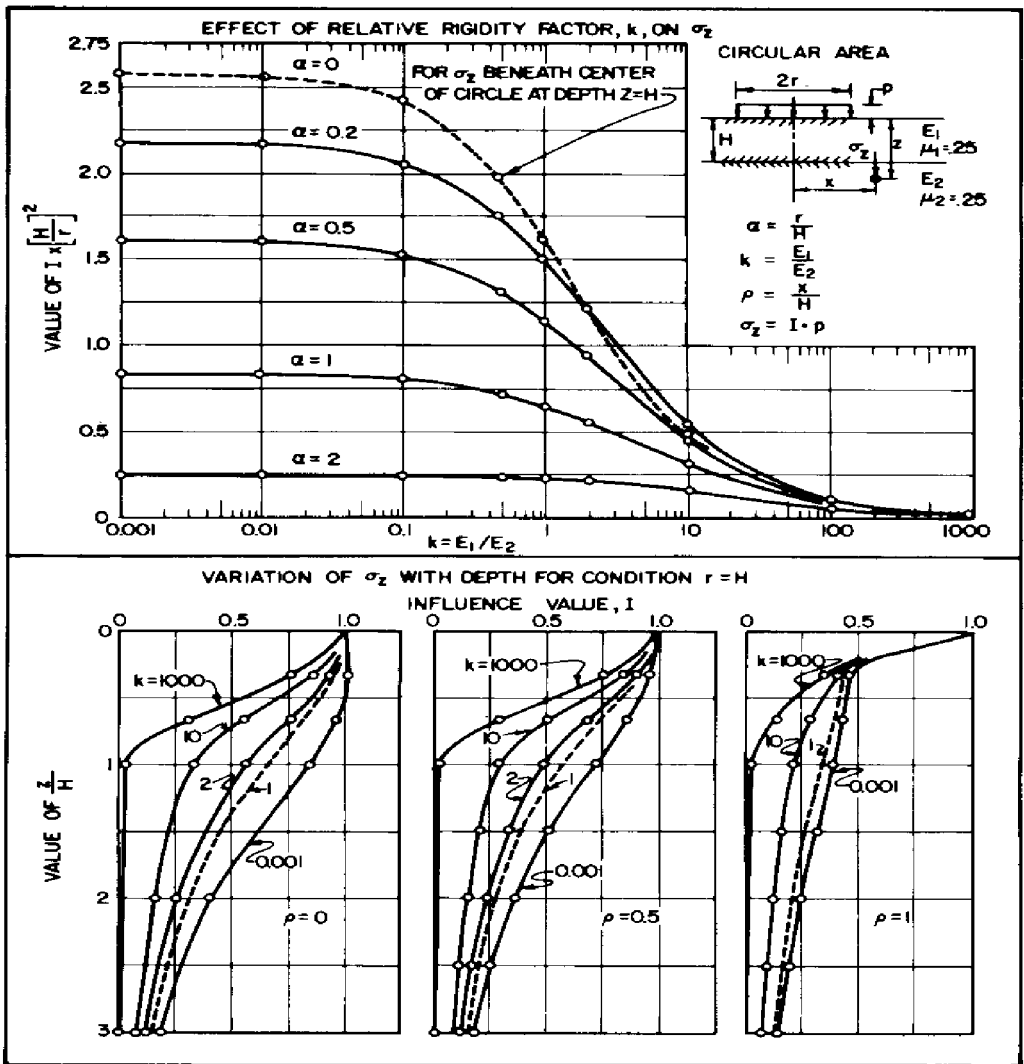

FIGURE 14  
 Influence Values for Vertical Stresses Beneath Uniformly Loaded  
 Circular Area (Two-Layer Foundation)

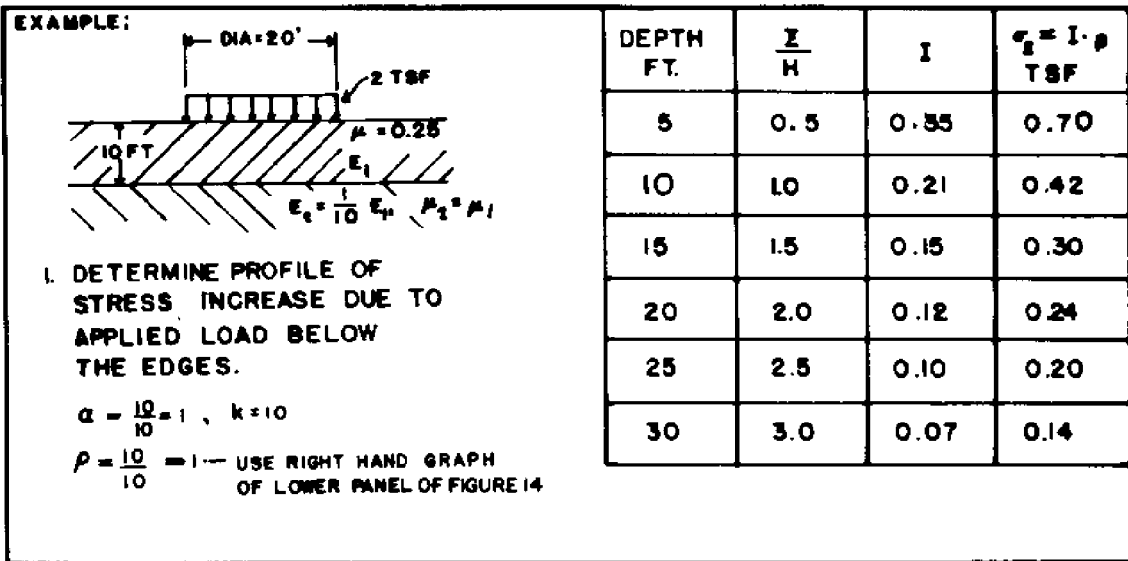

FIGURE 15  
Stress Profile in a Two-Layer Soil Mass

(1) Rigid Surface Layer Over Weaker Underlying Layer. If the surface layer is the more rigid, it acts as a distributing mat and the vertical stresses in the underlying soil layer are less than Boussinesq values.

(2) Weaker Surface Layer Over Stronger Underlying Layers. If the surface layer is less rigid than the underlying layer, then vertical stresses in both layers exceed the Boussinesq values. For influence diagrams for vertical stresses beneath rectangular loaded areas, see Reference 8, Stress and Displacement Characteristics of a Two-Layer Rigid Base Soil System: Influence Diagrams and Practical Applications, by Burmister. Use these influence diagrams to determine vertical stress distribution for settlement analysis involving a soft surface layer underlain by stiff material.

(3) Multi-Layer (Three or More) Systems. See Reference 6 for a discussion of the use of various approximate solutions for multi-layer systems.

c. Critical Depth. If there is no distinct change in the character of subsurface strata within the critical depth, elastic solutions for layered foundations need not be considered. Critical depth is the depth below the foundation within which soil compression contributes significantly to surface settlements. For fine-grained compressible soils, the critical depth extends to that point where applied stress decreases to 10 percent of effective overburden pressure. In coarse-grained material critical depth extends to that point where applied stress decreases to 20 percent of effective overburden pressure.

3. RIGID LOADED AREA. A rigid foundation must settle uniformly. When such a foundation rests on a perfectly elastic material, in order for it to deform uniformly the load must shift from the center to the edges, thus resulting in a pressure distribution which increases toward the edges (see Figure 16). This is the case for clays. In the case of sands, the soil near the edges yields because of the lack of confinement, thus causing the load to shift toward the center.

4. STRESSES INDUCED BY PILE LOADS. Estimates of the vertical stresses induced in a soil mass by an axially loaded pile are given in Figure 17 (Reference 9, Influence Scale and Influence Chart for the Computation of Stresses Due, Respectively, to Surface Point Load and Pile Load, by Grillo) for both friction and end-bearing piles. (See DM-7.2, Chapter 5 for further guidance on pile foundations.)

#### Section 4. SHALLOW PIPES AND CONDUITS

1. GENERAL. Pressures acting on shallow buried pipe and conduits are influenced by the relative rigidity of the pipe and surrounding soil, depth of cover, type of loading, span (maximum width) of structure, method of construction, and shape of pipe. This section describes simple procedures for determining pressures acting on a conduit in compressible soil for use in conduit design. For detailed analysis and design procedures for conduits in backfilled trenches and beneath embankments, consult one of the following:



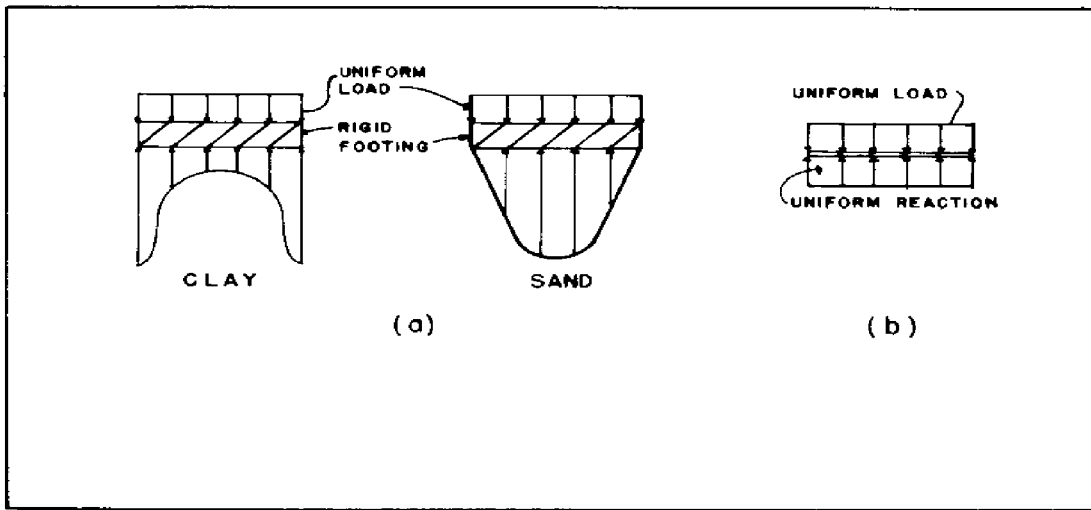

FIGURE 16  
 Contact Pressure Under (a) Rigid Footings  
 (b) Flexible Foundation on an Elastic Half Space

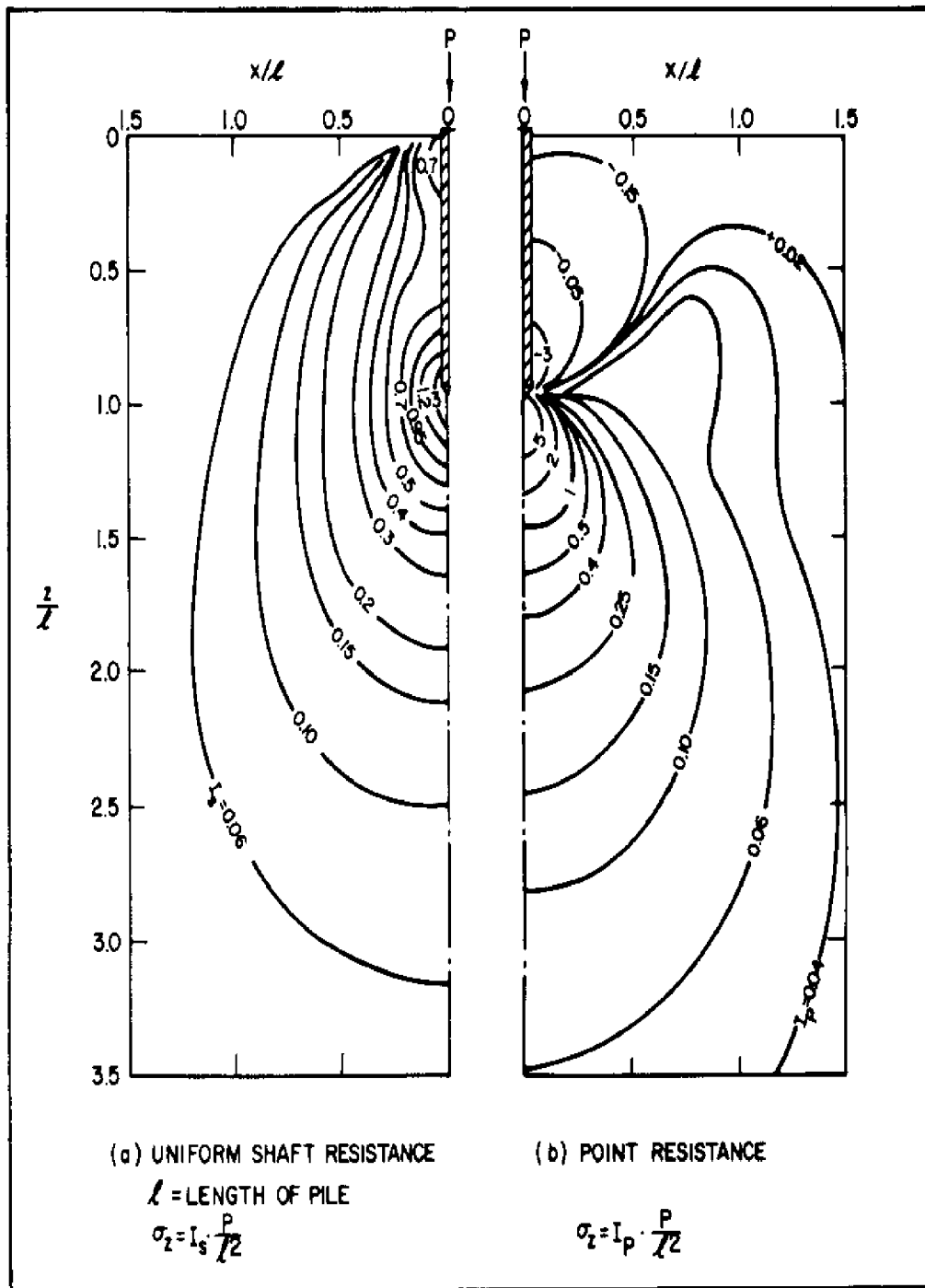

FIGURE 17  
 Influence Values for Vertical Stresses Around a Pile in an Elastic Solid

Reference 10, Buried Structures, by Watkins; Reference 11, Design and Construction of Sanitary and Storm Sewers, by the American Society of Civil Engineers; Reference 12, Handbook of Drainage and Construction Products, by Armco Drainage and Metal Products, Inc.; Reference 13, Engineering Handbook, Structural Design, by the U.S. Department of Agriculture, Soil Conservation Service; Reference 14, Concrete Pipe Design Manual, by American Concrete Pipe Association; or Reference 15, CANDE User Manual, by Katona and Smith.

2. RIGID PIPE. Pipes made from precast or cast-in-place concrete, or cast iron are considered rigid pipes.

a. Vertical Loads.

(1) Dead Load. Vertical soil pressure estimates for dead loads are obtained as follows:

EQUATION: 
$$W = C+w, .[\text{Upsilon}]-B. 2- \quad (4-1)$$

where  $W$  = total dead load on the conduit per unit length of conduit

$C+w$ , = correction coefficient; function of trench depth to width ratio, angle of trench side slopes, friction angle of backfill and trench sides, bedding conditions

$B$  = width of trench at level of top of pipe, or pipe outside diameter if buried under an embankment

$[\text{Upsilon}]$  = unit weight of backfill

$$\text{Dead load pressure, } P+DL, = \frac{W}{B}$$

(a) Embankment Fill. Use Figure 18a (Reference 16, Underground Conduits - An Appraisal of Modern Research, by Spangler) to determine embankment dead load. For soils of unit weight other than 100 pcf, adjust proportionately; e.g., for  $[\text{Upsilon}] = 120$  pcf, multiply chart by 1.20.

(b) Trench Backfill. Use Figure 18b (Reference 10) to determine values of  $C+w, .$

(c) Jacked or Driven Into Place. Use Figure 18c (Reference 17, Soft Ground Tunneling, by Commercial Shearing, Inc.) for  $C+w, .$  This diagram may also be used for jacked tunnels.

(2) Live Load. Vertical pressure due to surface load,  $P+LL, ,$  is calculated by Boussinesq equation (see Figure 2). Impact factor is included in the live load if it consists of traffic load. For example, an H-20 truck loading consists of two 16,000 lb. loads applied to two 10- by 20-inch areas. One of these loads is placed over the point in question, the other is 6 feet away. The vertical stresses produced by this loading including the effect of impact are shown in Figure 19 for various heights of cover.

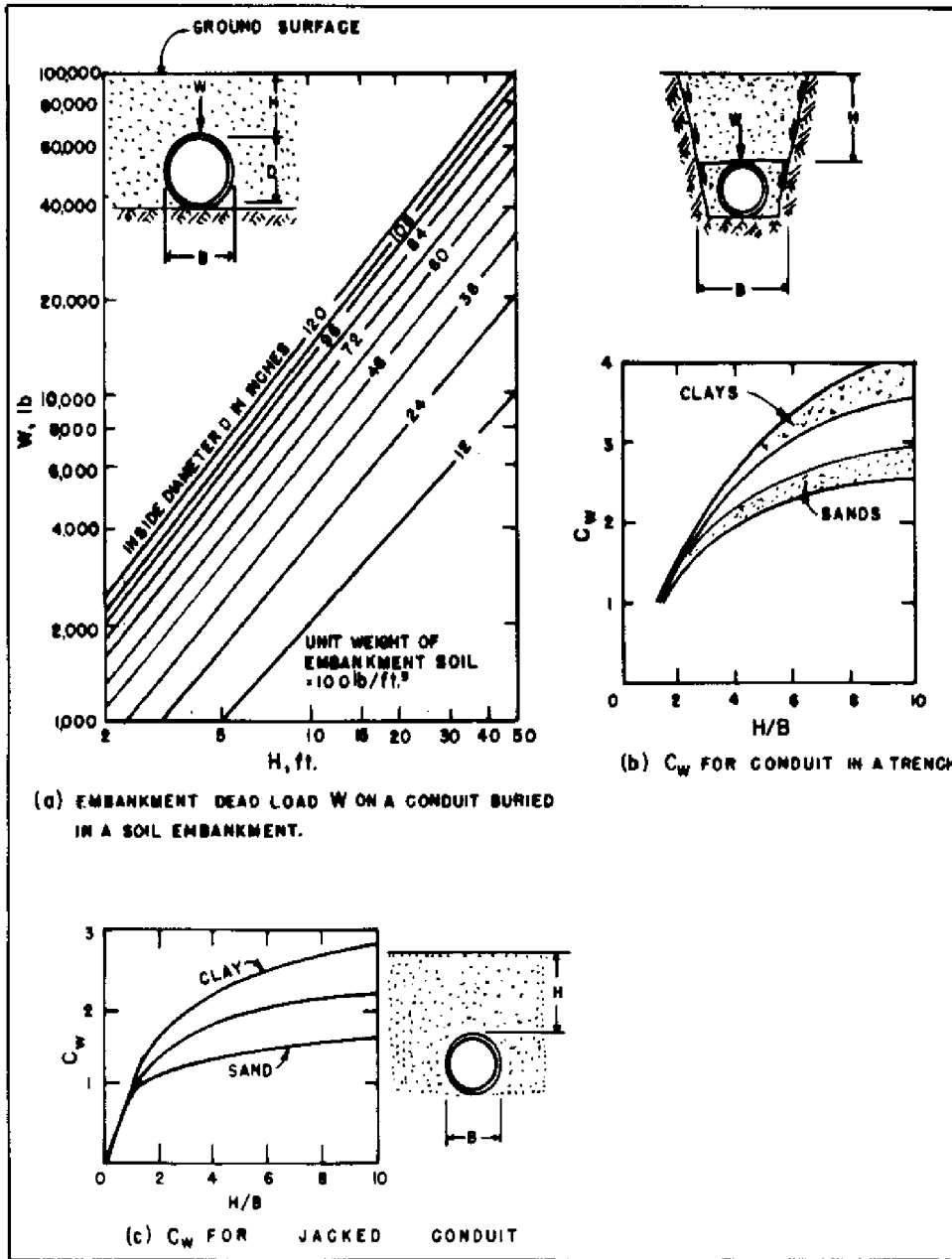
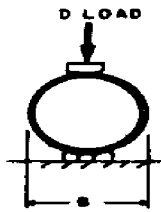

FIGURE 18  
 Backfill Coefficients, Embankment Loads, and Load Factors  
 for Rigid Conduits

(d) THREE EDGE BEARING METHOD.



(e) LOAD FACTORS  $L_f$  FOR RIGID PIPES BASED ON SPECIFIED CLASSES OF BEDDING.



CLASS A- CONCRETE CRADLE; B- COMPACTED GRANULAR MATERIAL; C- COMPACTED GRANULAR MATERIAL OR DENSELY COMPACTED BACKFILL; D- FLAT SUBGRADE.

	CLASS-A	CLASS-B	CLASS-C	CLASS-D
TRENCH <sup>a</sup>	4.8	1.9	1.5	1.1
"	3.4			
"	2.8			

<sup>a</sup>4.8 FOR 1.0% REINFORCING STEEL; 3.4 FOR 0.4% REINFORCING STEEL; 2.8 FOR PLAIN.

FIGURE 18 (continued)  
Backfill Coefficients, Embankment Loads, and Load Factors  
for Rigid Conduits

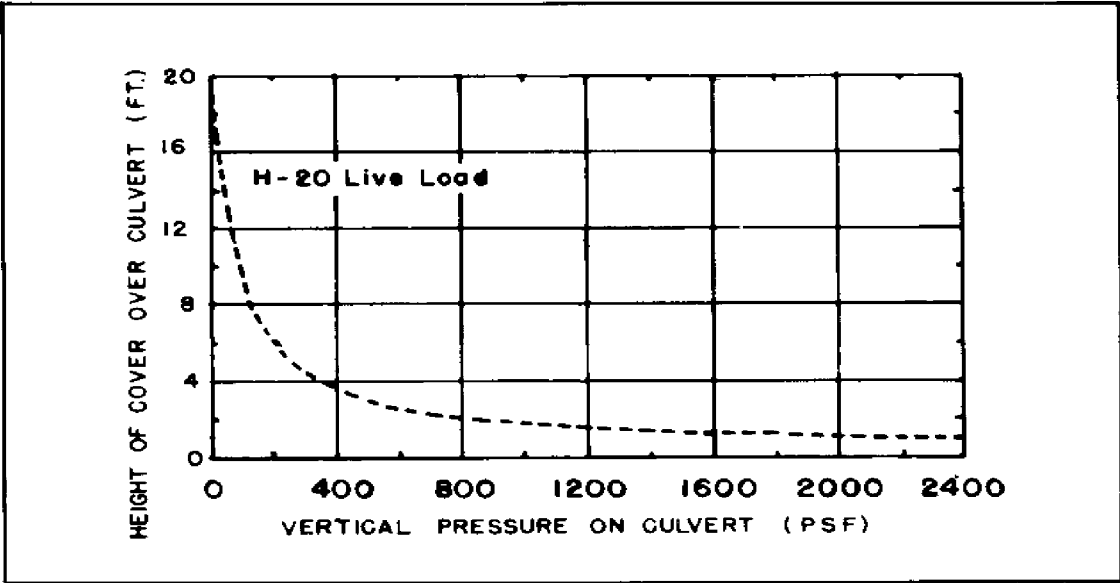

FIGURE 19  
Vertical Pressure on Culvert Versus Height of Cover

b. Design of Rigid Conduit. To design a rigid conduit, the computed loads (dead and live) are modified to account for bedding conditions and to relate maximum allowable load to the three-edge bearing test load D. (See Figure 18d.) See ASTM C76, Reinforced Concrete Culvert, Storm Drain, and Sewer Pipe, for test standards for D load.

Bedding conditions for pipes in trenches may be accounted for by use of a load factor, L+f, . Determine L+f, from Figure 18e (Reference 14). Determine D from the following equation:

$$\text{EQUATION:} \quad D+0.01, = \frac{N}{L+f,} (P+DL, + P+LL, ) \quad (4-2)$$

where  $D+0.01,$  = Allowable load in lb/ft of length of conduit per foot of inside diameter for a crack width of 0.01"

$L+f,$  = load factor

$N$  = safety factor (usually 1.25)

With the specified D load, the supplier is able to provide adequate pipe.

The soil pressure against the sides of a pipe in an embankment significantly influence the resistance of the pipe to vertical load. The load factor for such cases considers not only pipe bedding, but also pipe shape, lateral earth pressure, and the ratio of total lateral pressure to total vertical pressure. For further guidance see Reference 11.

3. FLEXIBLE STEEL PIPE. Corrugated or thin wall smooth steel pipes are sufficiently flexible to develop horizontal restraining pressures approximately equal to vertical pressures if backfill is well compacted. Vertical exterior pressure acting at the top of the pipe may range from pressures exceeding overburden pressure in highly compressible soils to much less than the overburden pressure in granular soils because of the effect of "arching", in which a portion of the overburden pressure is supported by the surrounding soil.

a. Vertical Loads.

(1) Dead Load. For flexible pipe, the dead load pressure is simply the height of the column of soil above the conduit times the unit weight of the backfill, as follows:.

$$\text{EQUATION:} \quad P+DL, = [\text{Upsilon}] [\text{multiplied by}] H \quad (4-3)$$

(2) Live Load. Computed by Boussinesq equations for rigid pipes.

(3) Pressure Transfer Coefficient. The dead load and live load pressures are modified by pressure transfer coefficient, C+p, , to yield apparent pressure, P, to be used in design.

$$\text{EQUATION:} \quad P = C+p, (P+LL, + P+DL, ) \quad (4-4)$$

See Figure 20 (Reference 18, Response of Corrugated Steel Pipe to External Soil Pressures, by Watkins and Moser) for the values of C+p, .

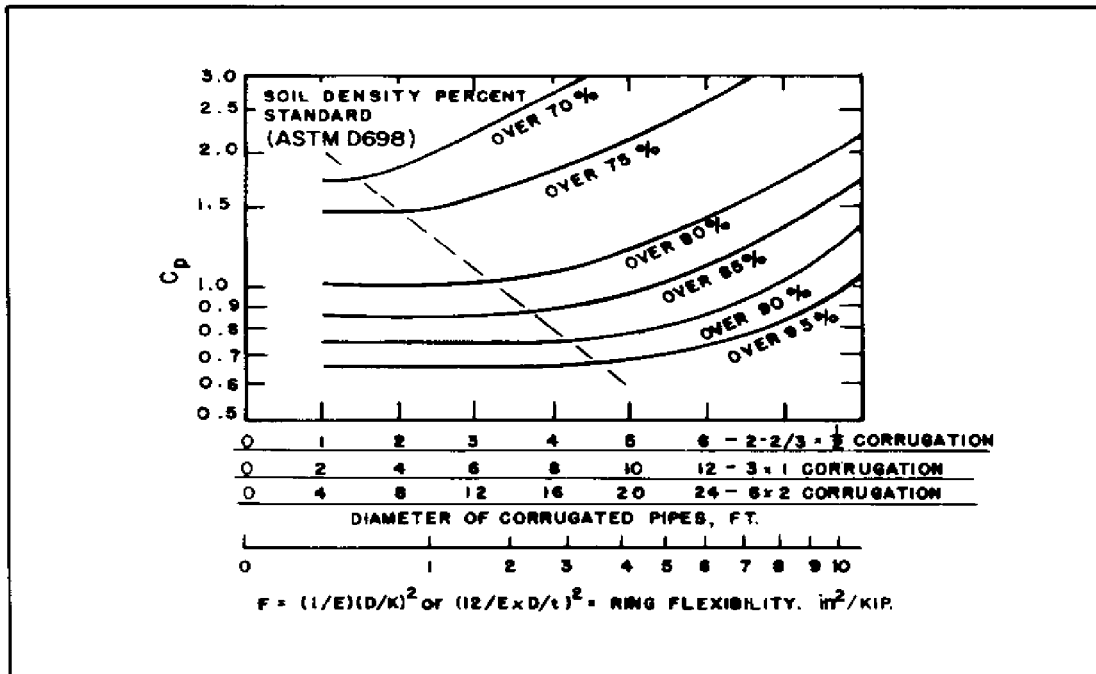

FIGURE 20  
Pressure Transfer Coefficients for Corrugated Flexible Conduits  
as a Function of Standard Soil Density and Ring Flexibility  
or Diameter and Corrugation Depth



b. Initial Designs. Use the following design procedures:

(1) Determine apparent ring compression stress of the pipe:

$$\text{EQUATION:} \quad \text{Apparent ring comp. stress} = \frac{PD}{2A} \quad (4-5)$$

where  $P$  = apparent vertical soil pressure on top of conduit,  
as determined from Equation (4-4)

$D$  = outside diameter of conduit

$A$  = cross-sectional area of the wall per unit length of conduit

(2) Equate apparent ring compression stress to allowable ring compression strength to determine required cross-sectional wall area,  $A$ , per unit length of pipe:

$$\text{EQUATION:} \quad \text{Allowable ring comp. strength} = \frac{S+y}{F+S} \quad (4-6)$$

$$\text{EQUATION:} \quad A = \frac{PDS+y}{2F+S} \quad (4-7)$$

where  $S+y$ , = yield point strength of the steel (typically 33 to 45 ksi)

$F+S$ , = safety factor (usually 1.5 to 2)

(3) Select appropriate pipe size to provide the minimum cross-sectional wall area  $A$  as determined above.

(4) Check ring deflection so that it does not exceed 5% of the nominal diameter of the pipe. Ring deflection  $Y$ , is governed by the total soil pressure  $P+v$ , =  $P+DL$ ,  $+P+LL$ , , diameter  $D$ , moment of inertia  $I$ , modulus of elasticity of conduit  $E$ , and soil modulus  $E'$ . Generally, ring deflection does not govern the design. See Figure 21 (Reference 10) for an example.

(5) The Handling Factor is the maximum flexibility beyond which ring is easily damaged. Pipe design must consider limiting the Handling Factor to such typical values as  $D \cdot 2 / EI = 0.0433$  in/lb for 2-2/3 x 1/2 corrugation and 0.0200 in/lb for 6 x 2 corrugation.

c. Soil Placement. Great care must be exercised in soil placement. Ring deflection and external soil pressures are sensitive to soil placement. If a loose soil blanket is placed around the ring and the soil is carefully compacted away from it, soil pressure is reduced considerably.

d. Design of Flexible Steel Pipe. For analysis and design procedures for large size flexible pipe of non-circular cross section, see Reference 12.

4. CONDUITS BENEATH EMBANKMENTS OF FINITE WIDTH. Design of culverts and conduits beneath narrow-crested embankments must consider the effect of the embankment base spread and settlement on the pipe.

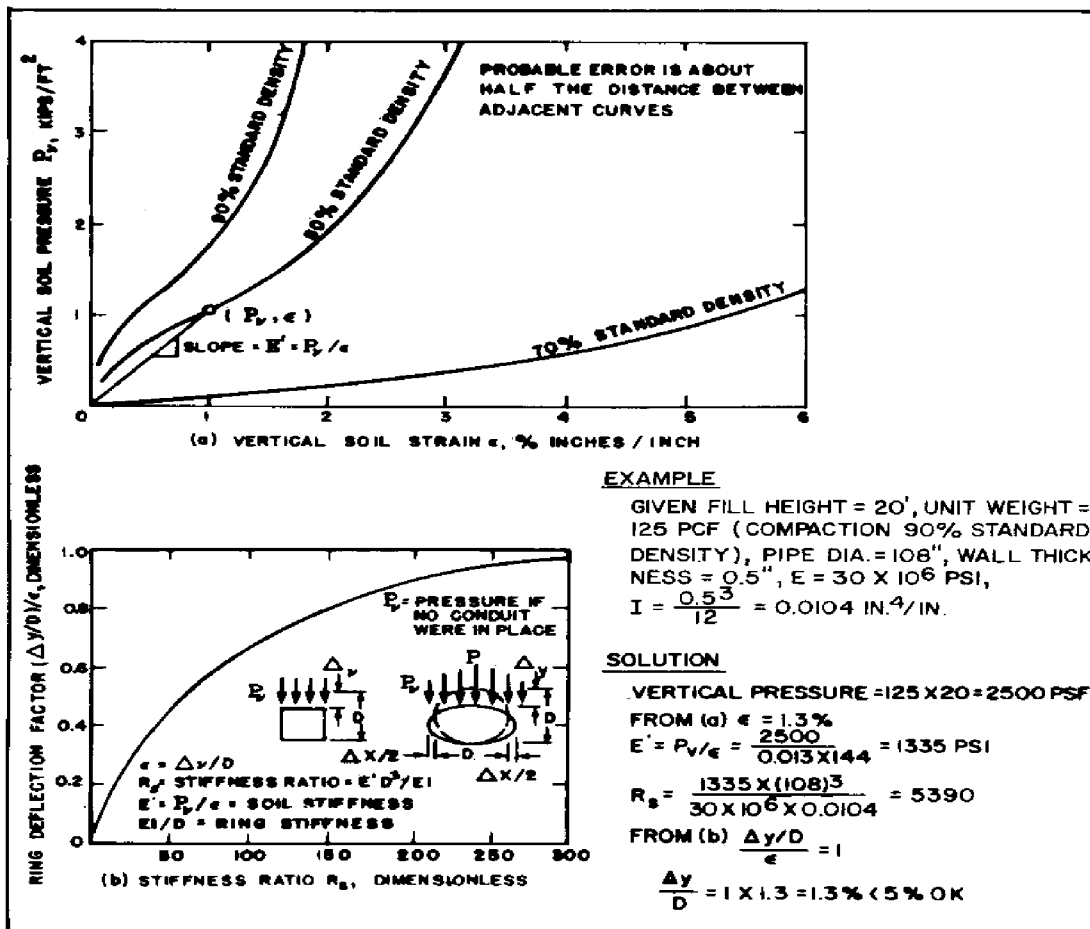

FIGURE 21  
Example of Ring Deflection

a. Longitudinal Extension. The maximum horizontal strain of a conduit beneath an embankment or earth dam occurs under the center of the fill. Maximum strain depends on the ratios  $b/h$ ,  $b/d$ , and the average vertical strain in the foundation beneath center of the fill. (See Figure 22 for the definitions and the relationship between vertical strain and horizontal strain.)

b. Joint Rotation. Besides the horizontal extension of the conduit, additional joint opening may occur at the bottom of the pipe because of settlement under the embankment load. For concrete pipe in sections about 12 feet long, compute additional joint opening due to settlement by Equation (4-8).

$$\text{EQUATION:} \quad \text{Opening} = \frac{[\delta] cr}{b} \quad (4-8)$$

where  $[\delta]$  = settlement of base of pipe at embankment centerline (in)

$b$  = embankment base width (in)

$c$  = constant, varying from 5 for uniform foundation conditions to 7 for variable foundation conditions

$r$  = pipe radius (in)

c. Pipe Selection. Compute total settlement below embankment by methods in Chapter 5. From this value, compute maximum joint opening at pipe mid-height as above. Add to this opening the spread at the top or bottom of the pipe from joint rotation computed from Equation (4-8).

Specify a pipe joint that will accommodate this movement and remain watertight. If the joint opening exceeds a safe value for precast concrete pipe, consider cast-in-place conduit in long sections with watertight expansion joints. Corrugated metal pipe is generally able to lengthen without rupture, but it may not be sufficiently corrosion resistant for water retention structures.

5. LONG SPAN METAL CULVERTS. The above methods are not applicable to very large, flexible metal culverts, i.e., widths in the range of 25 to 45 feet. For analysis and design procedures for these see Reference 19, Behavior and Design of Long Span Metal Culverts, by Duncan.

#### Section 5. DEEP UNDERGROUND OPENINGS

1. GENERAL FACTORS. Pressures acting on underground openings after their completion depend on the character of the surrounding materials, inward movement permitted during construction, and restraint provided by the tunnel lining.

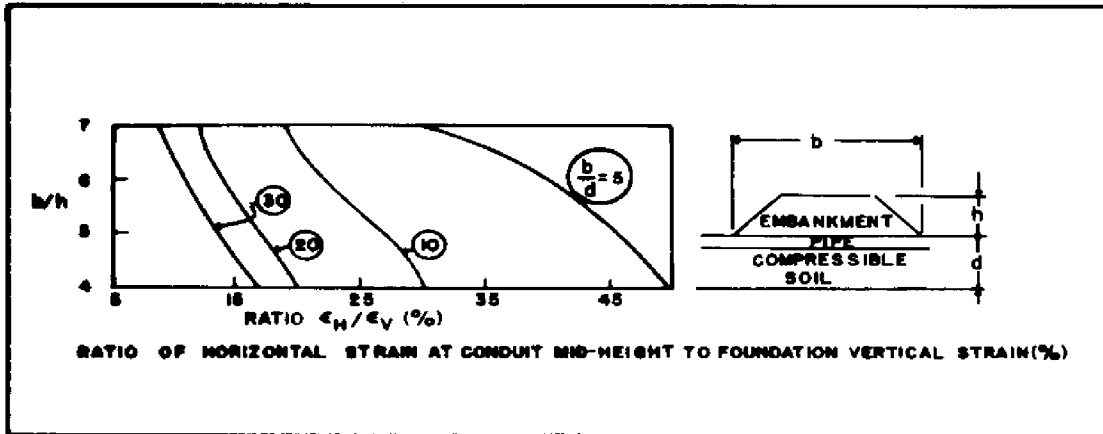

FIGURE 22  
Conduits Beneath Embankments of Finite Width

2. OPENINGS IN ROCK. Stress analysis differs for two rock groups: sound, nonswelling rock that can sustain considerable tensile stresses, and fractured blocky, seamy, squeezing, or swelling rock. For detailed explanations of these rock groups, see Chapter 1.

a. Sound Rock. Determine stresses surrounding tunnels or openings in intact, isotropic rock, such as crystalline igneous types, or homogeneous sandstone and limestone, by elastic analyses. Use the methods of Reference 20, Design of Underground Openings in Competent Rock, by Obert, et al.

For these materials, stresses in rock surrounding spheroidal cavities are lower than those for tunnels with the same cross section. Use elastic analyses to determine the best arrangement of openings and pillars, providing supports as required at locations of stress concentrations. For initial estimates of roof pressure, Table 1 (Reference 21, Rock Tunneling with Steel Supports, by Proctor and White) may be used.

b. Broken and Fractured Rock. Pressure on tunnels in chemically or mechanically altered rock must be analyzed by approximate rules based on experience. For details, see Reference 21.

c. Squeezing and Swelling Rocks. Squeezing rocks contain a considerable amount of clay. The clay fraction may be from non-swelling kaolinite group or from highly swelling montmorillonite group. These rocks are preloaded clays and the squeezing is due to swelling. The squeeze is intimately related to an increase in water content and a decrease in shear strength.

3. LOADS ON UNDERGROUND OPENINGS IN ROCK.

a. Vertical Rock Load. Table 1 gives the height of rock above the tunnel roof which must be supported by roof lining.

b. Horizontal Pressures. Determine the horizontal pressure  $P+a$ , on tunnel sides by applying the surcharge of this vertical rock load to an active failure wedge (see diagram in Table 1). Assume values of rock shear strength (see Chapter 3 for a range of values) on the active wedge failure plane, which allow for the fractured or broken character of the rock. Evaluate the possibility of movement of an active failure plane that coincides with weak strata or bedding intersecting the tunnel wall at an angle.

c. Support Pressures as Determined From Rock Quality. As an alternate method of analysis, use empirical correlations in Reference 22, Engineering Classification of Rock Masses for Tunnel Support, by Barton, et al., to determine required support pressures as a function of rock mass quality "Q". The analysis incorporates rock quality designation (RQD) and various joint properties of the surrounding material, and is applicable for sound or fractured rock. Results may be used directly for evaluating type of roof or wall support required.

TABLE 1  
Overburden Rock Load Carried by Roof Support

Rock Conditions	Rock Load $H_p$ in Feet	Remarks
1. Hard and intact	Zero	Sometimes spalling or popping occurs.
2. Hard stratified or schistose	0 to 0.5 B	Light pressures.
3. Massive, moderately jointed	0 to 0.25 B	Load may change erratically from point to point.
4. Moderately blocky and seamy	0.25 B to 0.35 (B+ $H_T$ )	No side pressure.
5. Very blocky and seamy	0.35 to 1.10 (B+ $H_T$ )	Little or no side pressure.
6. Completely crushed but chemically intact	1.10 (B+ $H_T$ )	Considerable side pressure. Softening effect of seepage towards bottom of tunnel.
7. Squeezing rock, moderate depth	(1.10 to 2.10) (B+ $H_T$ )	Heavy side pressure.
8. Squeezing rock, great depth	(2.10 to 4.50) (B+ $H_T$ )	
9. Swelling rock	Up to 250 ft. irrespective of value of (B+ $H_T$ )	Very heavy pressures.

Notes:

- Above values apply to tunnels at depth greater than 1.5 (B+ $H_T$ ).
- The roof of the tunnel is assumed to be located below the water table. If it is located permanently above the water table, the values given for rock conditions 4 to 6 can be reduced by fifty percent.
- Some very dense clays which have not yet acquired properties of shale rock may behave as squeezing or swelling rock.
- Where sandstone or limestone contain horizontal layers of immature shale, roof pressures will correspond to rock condition "very blocky and seamy."

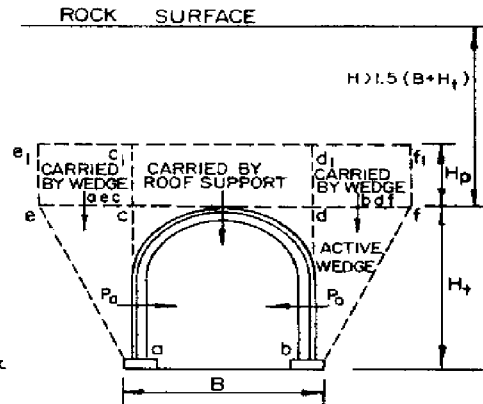

#### 4. OPENINGS IN SOFT GROUND.

a. Ground Behavior. The method of construction of tunnels depends upon the response of the ground during and after excavations. The stand up time depends upon the type of soil, the position of groundwater, and the size of opening. Depending upon the response during its movement period, the ground is classified as: (1) firm, (2) raveling, (3) running, (4) flowing, (5) squeezing or (6) swelling.

(1) In firm ground, no roof support is needed during excavation and there is no perceptible movement.

(2) In raveling ground, chunks or flakes of material begin to fall prior to installing the final ground supports. Stand up time decreases with increasing size of excavation. With rising groundwater, raveling ground may become running ground. Sand with clay binder is one example of this type of soil.

(3) In running ground, stand up time is zero. The roof support must be inserted prior to excavation. Removal of side supports results in inflow of material which comes to rest at its angle of repose. Dry cohesionless soils fall into this category.

(4) Flowing ground acts as a thick liquid and it invades the opening from all directions including the bottom. If support is not provided, flow continues until the tunnel is completely filled. Cohesionless soil below groundwater constitutes flowing ground.

(5) Squeezing ground advances gradually into the opening without any signs of rupture. For slow advancing soil, stand up time is adequate, yet the loss of ground results in settlement of the ground surface. Soft clay is a typical example of squeezing ground.

(6) Swelling ground advances into the opening and is caused by an increase in volume due to stress release and/or moisture increase. Pressures on support members may increase substantially even after the movement is restrained.

b. Loss of Ground. As the underground excavation is made, the surrounding ground starts to move toward the opening. Displacements result from stress release, soil coming into the tunnel from raveling, runs, flows, etc. The resulting loss of ground causes settlement of the ground surface. The loss of ground associated with stress reduction can be predicted reasonably well, but the ground loss due to raveling, flows, runs, etc. requires a detailed knowledge of the subsurface conditions to avoid unacceptable amounts of settlement. For acceptable levels of ground loss in various types of soils see Reference 23, Earth Tunneling with Steel Supports, by Proctor and White.

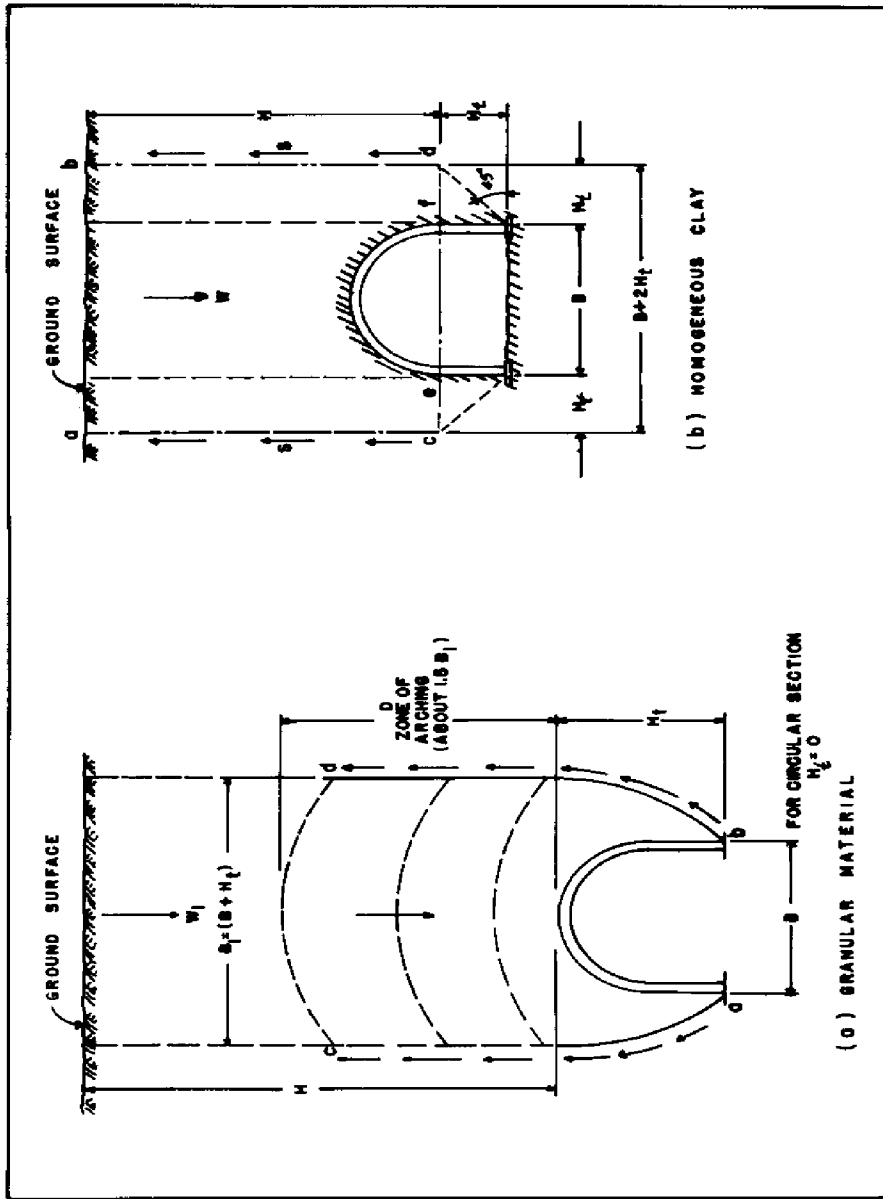

FIGURE 23  
 Load Action on Underground Openings in Earth



c. Loads. The support pressures in the underground openings are governed by the unit weight of the soil, groundwater table, soil properties, deformations during excavation, interaction between soil and the supports, shape of the opening, and the length of time that has elapsed since the installation of lining. Other factors such as the presence of another opening adjacent to it, excavation of a large deep basement near an existing opening, load from neighboring structures, and change in groundwater conditions, will also affect the design pressures on the tunnel supports. A schematic representation of the load action on underground openings is shown in Figure 23 (Reference 23).

Estimate of load for temporary supports in earth tunnels may be obtained from Table 2 (Reference 23). For further guidance see Reference 23 and Reference 24, Tunneling in Soft Ground, Geotechnical Considerations, by Peck.

## 5. PRESSURE ON VERTICAL SHAFTS.

a. Shaft in Sand. In the excavation of a vertical cylindrical shaft granular soils, pressures surrounding the shaft approach active values. If outward directed forces from a buried silo move the silo walls into the surrounding soil, pressures approach passive values as an upper limit.

(1) Pressure Coefficients. See Figure 24 for active and passive pressure coefficients for a cylindrical shaft of unlimited depth in granular soils.

(2) Modification of Active Pressures. For relatively shallow shafts (depth less than twice the diameter), rigid bracing at the top may prevent development of active conditions. In this case, horizontal pressures may be as large as at-rest pressures on a long wall with plane strain in the surrounding soil. (See DM-7.2, Chapter 3.)

(3) If groundwater is encountered, use submerged unit weight of sand and add hydrostatic pressure.

### b. Shaft in Clay.

(1) Pressure on Walls of Shafts in Soft Clay. For a cylindrical shaft, no support is needed from the ground surface to a depth of  $2c$   $z > 0$ ,  $= \gamma_{eff} z$ . To determine the approximate value of ultimate horizontal [Upsilon] earth pressure on a shaft lining at any depth  $z$ , use

$$p_h = [\text{Upsilon}] [multiplied by] z - c$$

where  $[\text{Upsilon}] =$  effective unit weight of clay

$z =$  depth

$c =$  cohesion

This pressure is likely to occur after several months.

TABLE 2  
 Loads For Temporary Supports in Earth Tunnels at Depths More Than  
 1.5 (B + H+t,)

+))))))))))0))))))))))0))))))))))))))))))))))))))))))))))))0))))))			
* Type of Ground	*Ground Condition	* Design Load[*] H+p,	* Remarks *
/))))))))))3))))))))))3))))))))))))))))))))))))))))))))))3))))))1	* Running	* Loose	* 0.50 (B + H+t,)
* ground above	* Medium	* 0.04 (B + H+t,)	* *
* water table	* Dense	* 0.30 (B + H+t,)	* *
/))))))))))3))))))))))3))))))))))))))))))))))))))))))))))2))))))1	* Running	* Disregard air pressure; H+p, equal to	
* ground in	* that for running ground, above water		
* compressed-air	* table with equal density.		
* tunnel	* *		
/))))))))))3))))))))))3))))))))))))))))))))))))))))))))))1	* Flowing ground	* H or 2 (B + H+t,)	
* in free-air	* whichever is smaller		
* tunnel	* *		
/))))))))))3))))))))))3))))))))))))))))))))))))))))))))))0))))))1	* Raveling	* Above water	* *T-t * H+p, (running)
* ground	* table	* * T *	* *
* *	* *	* . -	* *
* *	* *	* + ,	* *
* *	* Below water	* *T-t *	* *
* *	* table	* * ))) * H+p, (running)	* *
* *	* (free air)	* * T *	* *
* *	* *	* . -	* *
* *	* *	* + ,	* *
* *	* Below water	* *T-t *	* P+c,
* *	* table	* * ))) * 2H+p, - ))))	* *
* *	* (compressed air)	* * T *	* [Upsilon]
* *	* *	* . -	* *
/))))))))))3))))))))))3))))))))))))))))))))))))))))))))))3))))))1	* Squeezing	* Homogeneous	* H - )))) - )))) *After
* ground	* *	* [Upsilon] 2[Upsilon](B +2H+t,)	* complete *
* *	* *	* *	* *blowout, *
* *	* *	* *	* *
* *	* *	* P+c, Hq+u,	* *P+c, = 0 *
* *	* Soft roof, stiff	* H - )))) - )))) * *	* *
* *	* sides	* [Upsilon] 2[Upsilon] B *	* *
* *	* *	* *	* *
* *	* *	* P+c, Hq+u,	* *
* *	* Stiff roof, soft	* H - )))) - )))) * *	* *
* *	* sides	* [Upsilon] 2[Upsilon](B +6H+t,)	* *
.))))))))))2))))))))))2))))))))))))))))))))))))))))))))))2))))))-			

TABLE 2 (continued)  
 Loads For Temporary Supports in Earth Tunnels at Depths More Than  
 1.5 (B + H+t,)

* Type of Ground	* Ground Condition	* Design Load[*] H+p,	* Remarks
* Swelling ground	* Intact	* Very small	* Permanent roof support should be completed within a few days after mining
	* Fissured, above water table	* H+p, equal to that for raveling ground with same stand up time H	
	* Fissured, below water table, free-air tunnel		

\* p+c, = air pressure in pounds per square foot

\* q+u, = unconfined compressive strength of ground above roof in pounds per square foot

\* [Upsilon] = unit weight of soil in pounds per cubic foot

\* t = stand up time, minutes

\* T = elapsed time between excavating and completion of permanent structure, minutes

\* H = vertical distance between ground surface and tunnel roof in feet

\* H+p, = design load in feet of earth, see Table 1

\* H+t, = height of tunnel, see Table 1

\* B = width of tunnel, see Table 1

\* [\*] For circular tunnels, H+t, = 0, B = Diameter

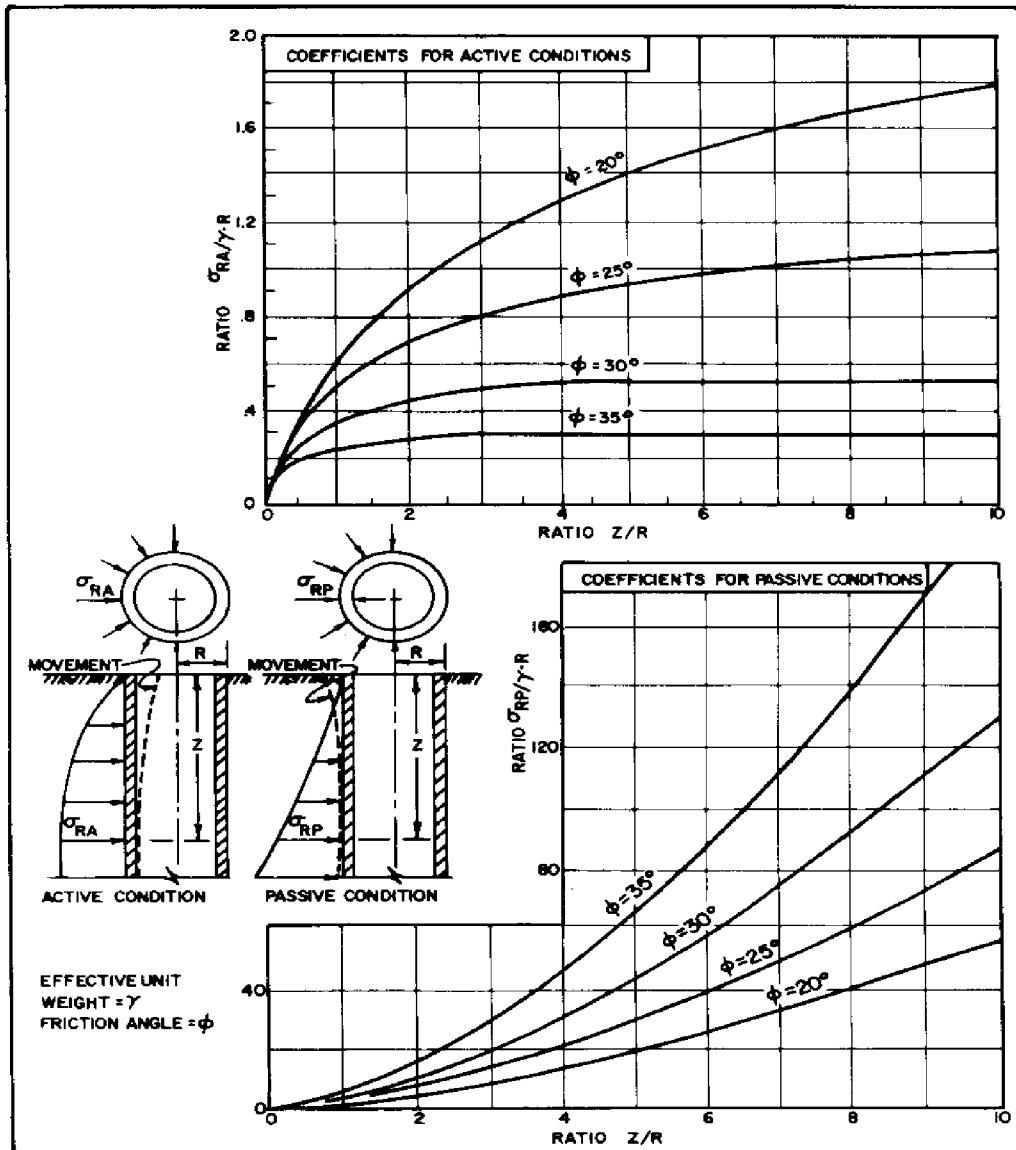

FIGURE 24  
Coefficients for Active or Passive Pressures on Underground  
Cylindrical Shafts or Silos

(2) Pressure on Walls of Shafts in Stiff Clay. On shafts located in stiff, intact, or fissured swelling clays, initially the pressure on the shaft lining is very small. Over a period of time, the pressure may increase to several times the overburden pressure (i.e., ultimately to the swelling pressure if shaft lining is sufficiently rigid). Local experience in that soil or field measurements can provide useful information. For further details of pressures on shafts, see Reference 23.

#### Section 6. NUMERICAL STRESS ANALYSIS

Stress analysis using numerical methods and computers are available for many simple as well as more complex loading conditions. See DM-7.3, Chapter 3 on available computer programs.

#### REFERENCES

1. Department of Civil Engineering, Institute of Transportation and Traffic Engineering, University of California, Berkeley, Stresses and Deflections in Foundations and Pavements, Fall, 1965.
2. Foster, C.R., and Ahlvin, P.G., Stresses and Deflections Induced by Uniform Circular Load, Highway Research Board Proceedings, Highway Research Board, Washington, DC, 1954.
3. Osterberg, J.O., Influence Values for Vertical Stresses in a Semi-Infinite Mass Due to an Embankment Loading, Proceedings, Fourth International Conference on Soil Mechanics and Foundation Engineering, London, 1957.
4. Jimenez Salas, J.A., Soil Pressure Computations: A Modification of Newmark's Method, Proceedings, Second International Conference on Soil Mechanics and Foundation Engineering, Rotterdam, 1948.
5. Poulos, H.G. and Davis, E.H., Elastic Solutions for Soil and Rock Mechanics, John Wiley & Sons, Inc., New York, 1974.
6. Duncan, J.M., and Buchignani, A.L., An Engineering Manual for Settlement Studies, Department of Civil Engineering, Institute of Transportation and Traffic Engineering, University of California, Berkeley, June, 1976.
7. Mehta, M.R., and Veletsos, A.S., Stresses and Displacement in Layered Systems, Structural Research Series No. 178, University of Illinois, Urbana, IL.
8. Burmister, D.M., Stress and Displacement Characteristics of a Two-Layer Rigid Base Soil System: Influence Diagrams and Practical Applications, Proceedings, Highway Research Board, Washington, DC, 1956.
9. Grillo, O., Influence Scale and Influence Chart for the Computation of Stresses Due, Respectively, to Surface Point Load and Pile Load, Proceedings of Second International Conference on Soil Mechanics and Foundation Engineering, Rotterdam, Vol. 6, pp 70-73, 1948.
10. Watkins, R.K., Buried Structures, Foundation Engineering Handbook, Winterkorn H.F. and Fang, F.Y., ed., Chapter 23, Van Nostrand and Reinhold Co., New York, 1975.
11. American Society of Civil Engineers, Design and Construction of Sanitary and Storm Sewers, Manuals and Reports of Engineering Practice, No. 37, ASCE, 1976.
12. Armco Drainage and Metal Products, Inc., Handbook of Drainage and Construction Products.
13. U. S. Department of Agriculture, Soil Conservation Service, Engineering Handbook, Structural Design, Section 6.

14. American Concrete Pipe Association, Concrete Pipe Design Manual, Vienna, VA, 1980.
15. Katona, M.G. and Smith, J.M., CANDE User Manual, FHWA-RD-77-6, Federal Highway Administration, October, 1976.
16. Spangler, M.G, Underground Conduits - An Appraisal of Modern Research, Transactions, ASCE, pp 316-373, 1948.
17. Commercial Shearing, Inc., Soft Ground Tunneling (company brochure), Catalog T-1, Youngstown, OH, 1971.
18. Watkins, R.K. and Moser, A.P., Response of Corrugated Steel Pipe to External Soil Pressures, Highway Research Record Number 373, Highway Research Board, 1971.
19. Duncan, J.M., Behavior and Design of Long Span Metal Culverts, Journal of the Geotechnical Engineering Division, ASCE, Vol. 105, No. GT3, 1979.
20. Obert, L., Duvall, W.I. and Merrill, R.H., Design of Underground Openings in Competent Rock, Bulletin, U.S. Bureau of Mines.
21. Proctor, R.V. and White, T.L., Rock Tunneling With Steel Supports, Commercial Shearing Inc., Youngstown, OH, 1968.
22. Barton, N., Lien, R. and Lunde, J., Engineering Classification of Rock Masses for Tunnel Support, Rock Mechanics, Volume 6, No. 4, Journal International Society of Rock Mechanics, 1974.
23. Proctor, R.V. and White, T.L., Earth Tunneling With Steel Supports, Commercial Shearing, Inc., Youngstown, OH, 1977.
24. Peck, R.B., Tunneling in Soft Ground, Geotechnical Considerations, Seminar on Underground Construction, Vail, CO, 1976.
25. Naval Facilities Engineering Command, Design Manuals (DM)

DM-5.03                      Drainage Systems  
DM-21 Series                Airfield Pavements

Copies of design manuals may be obtained, from the U.S. Naval Publications and Forms Center, 5801 Tabor Avenue, Philadelphia, Pennsylvania 19120.

## CHAPTER 5. ANALYSIS OF SETTLEMENT AND VOLUME EXPANSION

### Section 1. INTRODUCTION

1. SCOPE. This chapter concerns (a) immediate settlements, (b) long-term settlements, (c) rate of settlement, (d) criteria for tolerable settlement, (e) methods of reducing or accelerating settlements for saturated fine-grained soils and (f) methods for controlling and/or estimating heave in swelling soils. Procedures given are for fine-grained compressible soils as well as for coarse-grained soils.

Guidance in other special cases such as collapsing soil, sanitary land fill, etc., is provided in DM-7.3, Chapter 3. Monitoring of settlements is discussed in Chapter 2.

2. OCCURRENCE OF SETTLEMENTS. The settlement of saturated cohesive soil consists of the sum of three components; (1) immediate settlement occurring as the load is applied, (2) consolidation settlement occurring gradually as excess pore pressures generated by loads are dissipated, and (3) secondary compression essentially controlled by the composition and structure of the soil skeleton.

The settlement of coarse-grained granular soils subjected to foundation loads occurs primarily from the compression of the soil skeleton due to rearrangement of particles. The permeability of coarse-grained soil is large enough to justify the assumption of immediate excess pore pressure dissipation upon application of load. Settlement of coarse-grained soil can also be induced by vibratory ground motion due to earthquakes, blasting or machinery, or by soaking and submergence.

3. APPLICABILITY. Settlement estimates discussed in this chapter are applicable to cases where shear stresses are well below the shear strength of the soil.

### Section 2. ANALYSIS OF STRESS CONDITIONS

1. MECHANICS OF CONSOLIDATION. See Figure 1. Superimposed loads develop pore pressures in compressible strata exceeding the original hydrostatic pressures. As pore pressure gradients force water from a compressible stratum, its volume decreases, causing settlement.

2. INITIAL STRESSES. See Figure 2 for profiles of vertical stress in a compressible stratum prior to construction. For equilibrium conditions with no excess hydrostatic pressures, compute vertical effective stress as shown in Case 1, Figure 2.



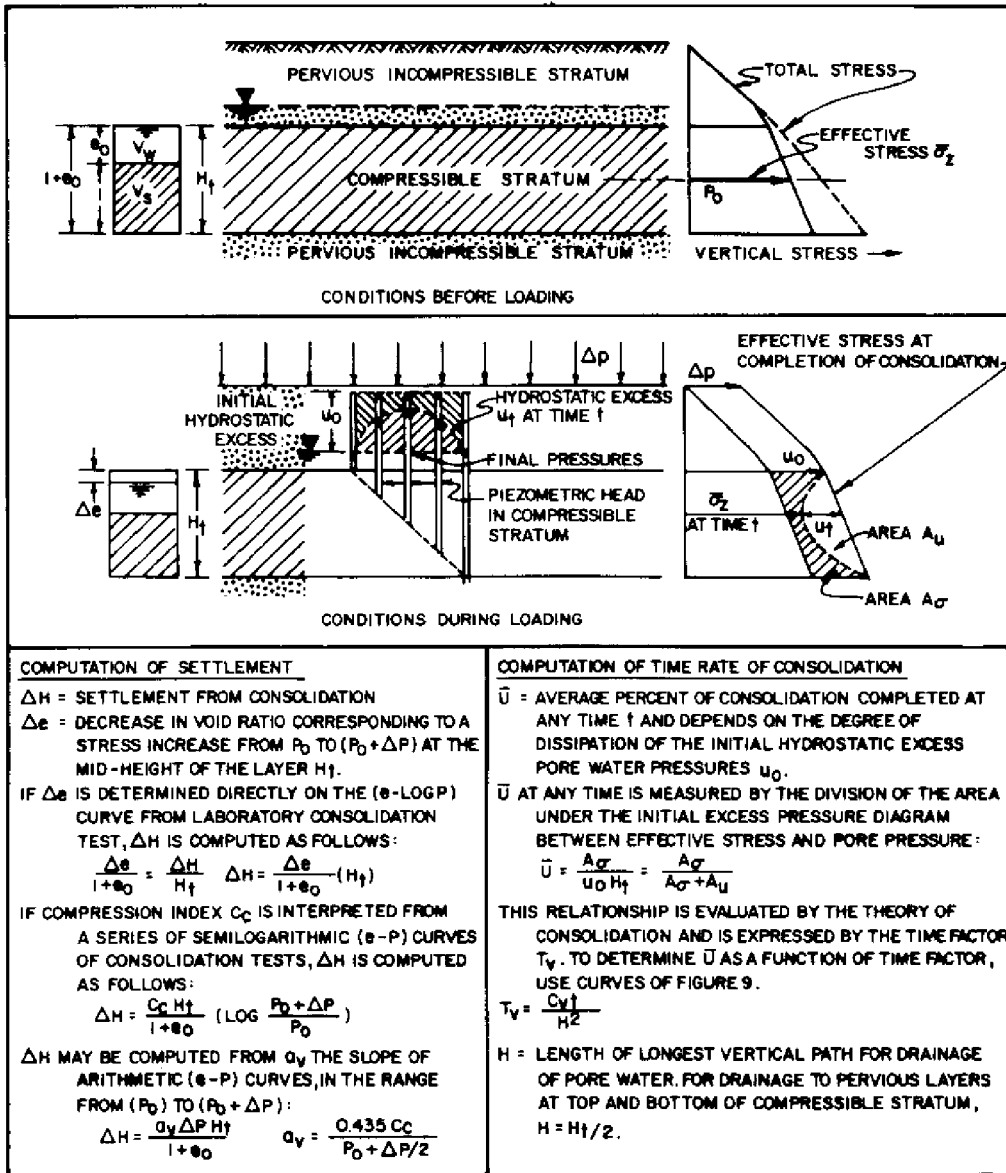

FIGURE 1  
Consolidation Settlement Analysis

STRESS CONDITION	DIAGRAM OF VERTICAL STRESSES	DESCRIPTION
(1) SIMPLE OVERBURDEN PRESSURE		TOTAL STRESS $\sigma_v$ IS COMPUTED USING TOTAL UNIT WEIGHT $\gamma$ BOTH ABOVE AND BELOW THE G.W.L. PORE WATER PRESSURE $u$ IS DUE TO G.W.L. EFFECTIVE STRESS $\sigma'_v = \sigma_v - u$ .
(2) LOWERING OF GROUND WATER LEVEL		IMMEDIATELY AFTER LOWERING OF THE GROUNDWATER TOTAL STRESS IN TOP SAND LAYER REMAINS PRACTICALLY UNCHANGED, BUT THE EFFECTIVE STRESSES INCREASE. SINCE THE WATER ESCAPES SLOWLY FROM THE CLAY LAYER, THE EFFECTIVE STRESS REQUIRES LONG TIME TO REACH THE NEW EQUILIBRIUM VALUE.
(3) PARTIAL CONSOLIDATION UNDER WEIGHT OF INITIAL FILL		TOTAL STRESSES ON A CLAY LAYER INCREASED BY THE ADDITION OF SURCHARGE LOAD. INITIALLY THIS LOAD IS CARRIED BY PORE WATER IN THE FORM OF EXCESS PORE PRESSURE. AS THE SETTLEMENT PROGRESSES IN THE CLAY LAYER, THE EFFECTIVE STRESS INCREASES TO CORRESPOND TO THE STRESS FROM SURCHARGE LOAD.
(4) RISE OF GROUND WATER LEVEL		RISE OF GROUND WATER LEVEL DECREASES EFFECTIVE PORE PRESSURE OF OVERBURDEN. EFFECTIVE STRESS LINE MOVES TO LEFT. THEN PRE-CONSOLIDATION STRESS EQUALS ORIGINAL EFFECTIVE STRESS OVERBURDEN. TOTAL STRESS PRACTICALLY UNCHANGED.

FIGURE 2  
Profiles of Vertical Stresses Before Construction

PRECONSOLIDATED CONDITIONS		STRESS CONDITION	DIAGRAM OF VERTICAL STRESSES	DESCRIPTION
(5)	EXCAVATION		EXCAVATION OF OVERBURDEN MATERIAL UNLOADS CLAY LAYER. EFFECTIVE STRESS LINE MOVES TO THE LEFT. THEN PRECONSOLIDATION STRESS EQUALS ORIGINAL EFFECTIVE STRESS OF OVERBURDEN.	
(6)	PRECONSOLIDATION FROM LOADING IN THE PAST		PRECONSOLIDATION FROM PAST LOADINGS GREATER THAN THE EXISTING OVERBURDEN MAY HAVE BEEN CAUSED BY WEIGHT OF GLACIAL ICE, EROSION OF FORMER OVERBURDEN, LOWER GROUND WATER LEVEL PLUS DESSICATION, OR REMOVAL OF FORMER STRUCTURES.	
(7)	ARTESIAN PRESSURE		SAND STRATUM BELOW THE CLAY MAY BE SUBJECT TO ARTESIAN HYDRAULIC PRESSURES THAT DECREASE EFFECTIVE STRESS AT BASE OF CLAY. TOTAL STRESS REMAINS UNCHANGED.	

FIGURE 2 (continued)  
Profiles of Vertical Stresses Before Construction

a. Preconsolidation. Stresses exceeding the present effective vertical pressure of overburden produce preconsolidation (1) by the weight of material that existed above the present ground surface and that has been removed by erosion, excavation, or recession of glaciers, (2) by capillary stresses from desiccation, and (3) by lower groundwater levels at some time in the past.

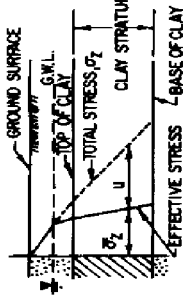
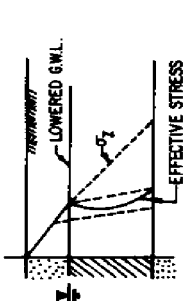
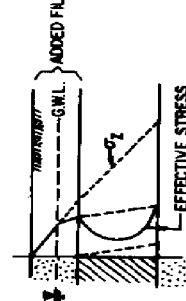
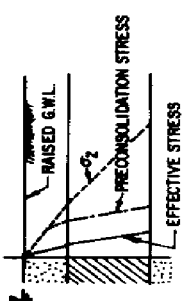
b. Underconsolidation. Compressible strata may be incompletely consolidated under existing loads as a result of recent lowering of groundwater or recent addition of fills or structural loads. Residual hydrostatic excess pore pressure existing in the compressible stratum will dissipate with time, causing settlements.

c. Evaluation of Existing Conditions. Determine consolidation condition at start of construction by the following steps:

(1) Review the data available on site history and geology to estimate probable preconsolidation or underconsolidation.

(2) Compare profile of preconsolidation stress determined from laboratory consolidation tests (Chapter 3) with the profile of effective over-burden pressures.

(3) Estimate preconsolidation from  $c/P+c$ , ratio, where  $c$  is the cohesion ( $q+u/2$ ,) and  $P+c$ , is the preconsolidation stress, using laboratory data from unconfined compression test and Atterberg limits (see Chapter 3).

(4) If underconsolidation is indicated, install piezometers to measure the magnitude of hydrostatic excess pore water pressures.

d. Computation of Added Stresses. Use the elastic solutions (Chapter 4) to determine the vertical stress increment from applied loads. On vertical lines beneath selected points in the loaded area, plot profiles of estimated preconsolidation and effective overburden stress plus the increment of applied stress. See Figure 3 for typical profiles. Lowering of groundwater during construction or regional drawdown increases effective stress at the boundaries of the compressible stratum and initiates consolidation. Stress applied by drawdown equals the reduction in buoyancy of overburden corresponding to decrease in boundary water pressure. In developed locations, settlement of surrounding areas from drawdown must be carefully evaluated before undertaking dewatering or well pumping.

### Section 3. INSTANTANEOUS SETTLEMENT

1. IMMEDIATE SETTLEMENT OF FINE-GRAINED SOILS. Generally, the instantaneous settlement results from elastic compression of clayey soil. For foundations on unsaturated clay or highly overconsolidated clay, the elastic settlement constitutes a significant portion of the total settlement.

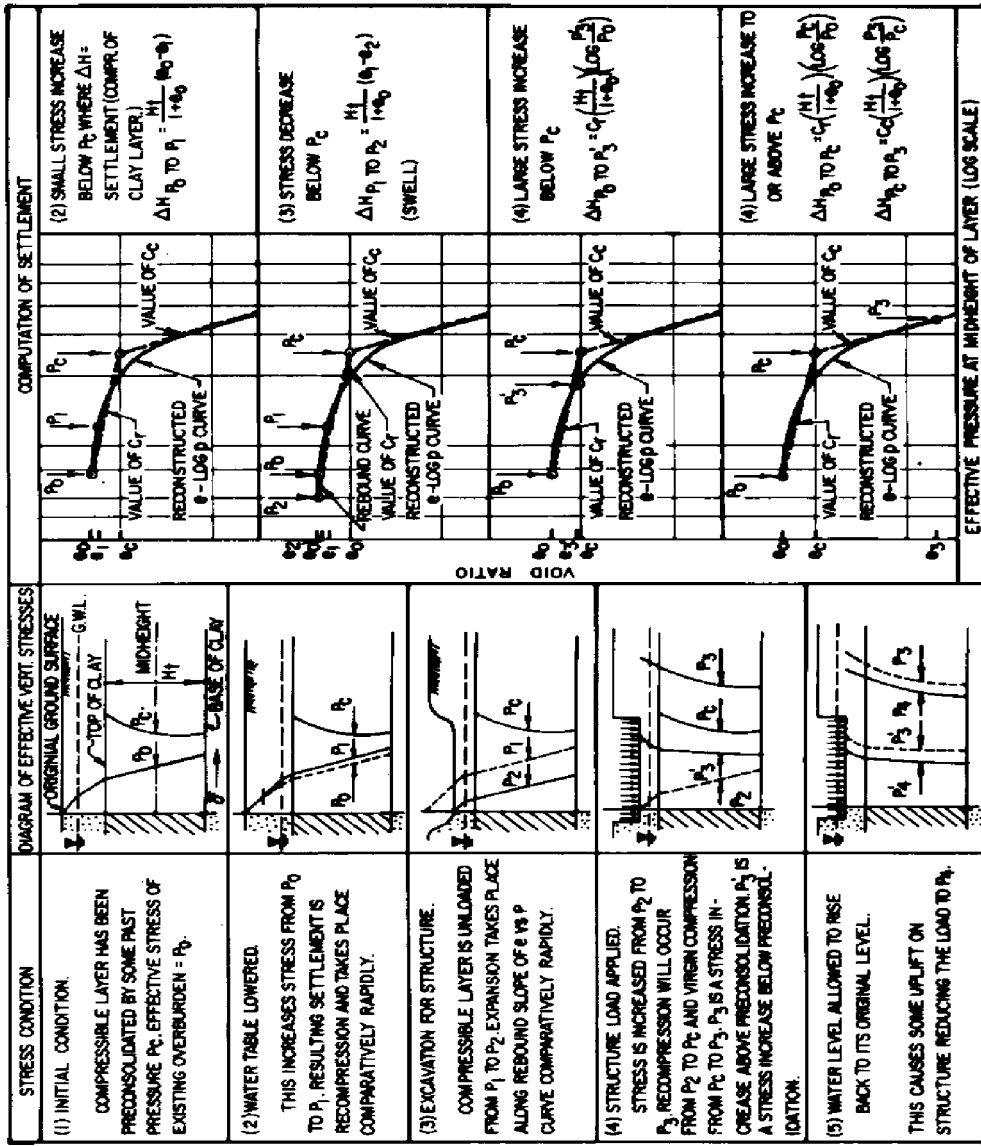

FIGURE 3  
Computation of Total Settlement for Various Loading Conditions

Immediate settlement  $[\delta]_v$ , is estimated as:

$$[\delta]_v = q B \frac{1 - [\gamma] + 2}{E + u} I$$

$q$  is applied uniform pressure;  $B$  is width of loaded area;  $I$  is combined shape and rigidity factor;  $[\gamma]$  is Poisson's ratio - ranges between 0.3 and 0.5, the higher value being for saturated soil with no volume change during loading; and  $E + u$ , is undrained modulus obtained from laboratory or field (pressuremeter) tests. Table 1 (Reference 1, Stresses and Deflections in Foundations and Pavements, by Department of Civil Engineering, University of California, Berkeley) provides values of  $I$ . Empirical relationship derived from field measurement may be used to determine  $E + u$ , when actual test values are not available; see Table 2 (adapted from Reference 2, An Engineering Manual For Settlement Studies, by Duncan and Buchignani). Empirical correlations for estimation of OCR (Over Consolidation Ratio) are presented in Chapter 3.

If the factor of safety against bearing failure (see DM-7.2, Chapter 4) is less than about 3, then the immediate settlement  $[\delta]_v$ , is modified as follows:

$$[\delta]_c = [\delta]_v / SR,$$

$[\delta]_c$  = immediate settlement corrected to allow for partial yield condition

SR = Settlement Ratio

Determine SR from Figure 4 (Reference 3, Initial Settlement of Structures on Clay, by D'Appolonia, et al.). See Figure 5 for an example.

2. SETTLEMENT OF COARSE-GRAINED SOILS. This immediate settlement is a function of the width and depth of footing, elevation of the water table, and the modulus of vertical subgrade reaction ( $K + VI$ ) within the depth affected by the footing. Figure 6 may be used to estimate  $K + VI$ , from the soil boring log, and to compute anticipated settlement.

For large footings where soil deformation properties vary significantly with depth or where the thickness of granular soil is only a fraction of the width of the loaded area, the method in Figure 6 may underestimate settlement.

3. TOTAL SETTLEMENT IN GRANULAR SOILS. Total settlement is the combined effect of immediate and long-term settlements. A usually conservative estimate of settlement can be made utilizing the method in Figure 7 (Reference 4, Static Cone to Compute Static Settlement Over Sand, by Schmertmann). A review of methods dealing with settlement of sands utilizing the standard penetration test results can be found in Reference 5, Equivalent Linear Model for Predicting Settlements of Sand Bases, by Oweis.

TABLE 1

Shape and Rigidity Factors I for Calculating Settlements  
of Points on Loaded Areas at the Surface of an Elastic Half-Space

Shape and Rigidity Factor I for Loaded Areas on an Elastic Half-Space of Infinite Depth					
Shape and Rigidity	Center	Corner	Edge/Middle of Long Side	Average	
Circle (flexible)	1.00		0.64	0.85	
Circle (rigid)	0.79		0.79	0.79	
Square (flexible)	1.12	0.56	0.76	0.95	
Square (rigid)	0.82	0.82	0.82	0.82	
Rectangle: (flexible) length/width					
2	1.53	0.76	1.12	1.30	
5	2.10	1.05	1.68	1.82	
10	2.56	1.28	2.10	2.24	
Rectangle: (rigid) length/width					
2	1.12	1.12	1.12	1.12	
5	1.6	1.6	1.6	1.6	
10	2.0	2.0	2.0	2.0	

TABLE 1 (continued)  
 Shape and Rigidity Factors I for Calculating Settlements  
 of Points on Loaded Areas at the Surface of an Elastic Half-Space

Shape and Rigidity Factor I for Loaded Areas on an Elastic Half-Space of Limited Depth Over a Rigid Base						
H/B	Center of Rigid Circular Area Diameter = B	Corner of Flexible Rectangular Area				
		L/B = 1	L/B = 2	L/B = 5	L/B = 10	(strip) L/B = ∞
for $\nu = 0.50$						
0	0.00	0.00	0.00	0.00	0.00	0.00
0.5	0.14	0.05	0.04	0.04	0.04	0.04
1.0	0.35	0.15	0.12	0.10	0.10	0.10
1.5	0.48	0.23	0.22	0.18	0.18	0.18
2.0	0.54	0.29	0.29	0.27	0.26	0.26
3.0	0.62	0.36	0.40	0.39	0.38	0.37
5.0	0.69	0.44	0.52	0.55	0.54	0.52
10.0	0.74	0.48	0.64	0.76	0.77	0.73
for $\nu = 0.33$						
0	0.00	0.00	0.00	0.00	0.00	0.00
0.5	0.20	0.09	0.08	0.08	0.08	0.08
1.0	0.40	0.19	0.18	0.16	0.16	0.16
1.5	0.51	0.27	0.28	0.25	0.25	0.25
2.0	0.57	0.32	0.34	0.34	0.34	0.34
3.0	0.64	0.38	0.44	0.46	0.45	0.45
5.0	0.70	0.46	0.56	0.60	0.61	0.61
10.0	0.74	0.49	0.66	0.80	0.82	0.81

RIGID BASE

RECTANGLE      CIRCLE

LOCATION OF INFLUENCE POINT

NOTATION FOR LOADED AREAS, SHOWN IN PLAN VIEW



TABLE 1 (continued)  
 Shape and Rigidity Factors I for Calculating Settlements  
 of Points on Loaded Areas at the Surface of an Elastic Half-Space

Example:

Compute immediate settlement at center of uniformly loaded area  
 (flexible) measuring 20' by 20'.

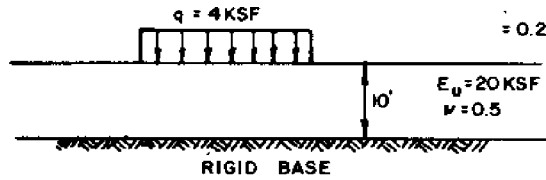
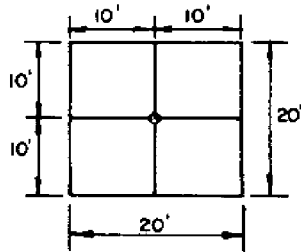

Calculate as the sum of the  
 influence values at the  
 corners of four equal-sided  
 rectangles.

$$\delta_v = qB \frac{1-\nu^2}{E_u} I$$

$$q = 4 \text{ KSF}, B = 10'$$

$$\nu = 0.5, E_u = 20 \text{ KSF}$$

$$H/B = 1, L/B = 1 \quad I = 0.15$$

$$\delta = 4 \times 10 \times \left[ \frac{1-0.5^2}{20} \right] \times 0.15$$

$$= 0.225'$$

TABLE 2

Relationship Between Undrained Modulus and Overconsolidation Ratio

+	OCR[*]	0	Eu/c	0	0	1
/		3		0	0	1
*		PI<30	30<PI<50	PI>50	*	*
*	<3	600	300	125	*	*
*	3 - 5	400	200	75	*	*
*	>5	150	75	50	*	*
.		2	2	2	-	-

[\*] OCR = Overconsolidation ratio

c = Undrained shear strength

PI = Plastic index

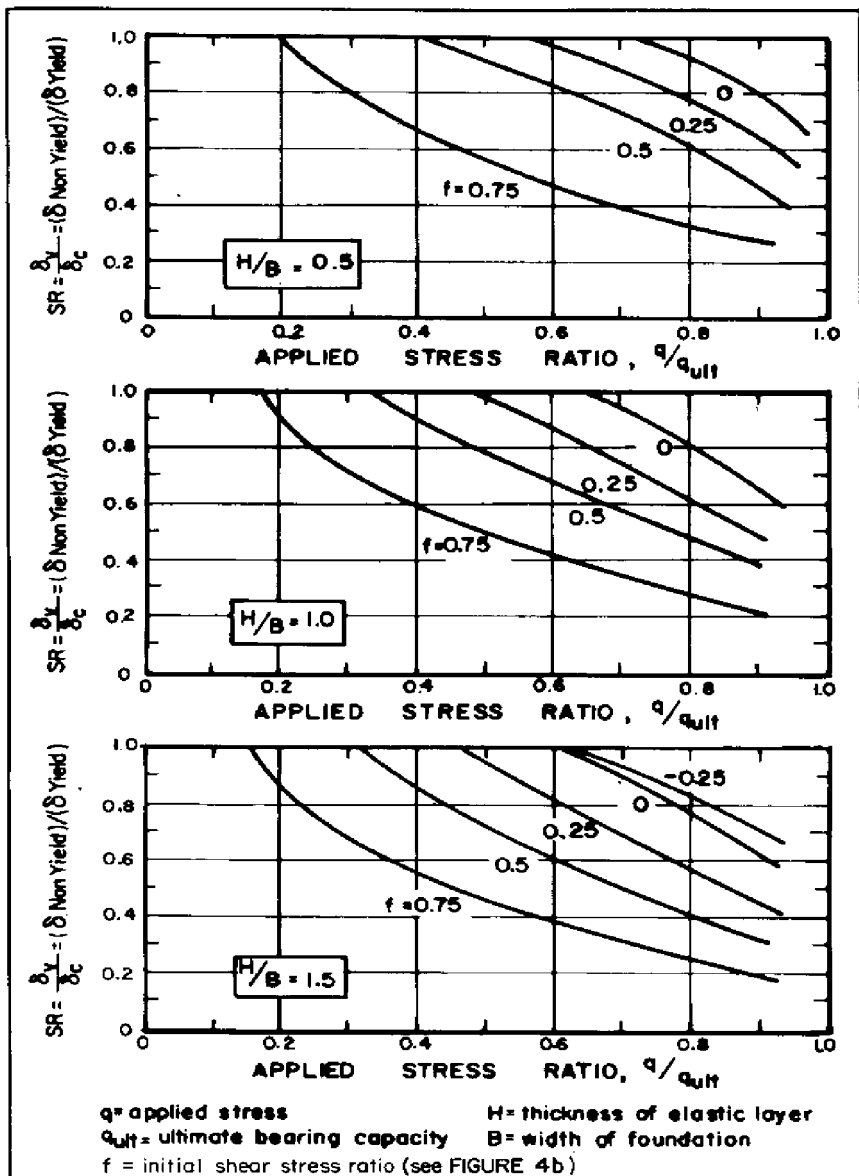

FIGURE 4a  
 Relationship Between Settlement Ratio and Applied Stress Ratio  
 for Strip Foundation on Homogeneous Isotropic Layer

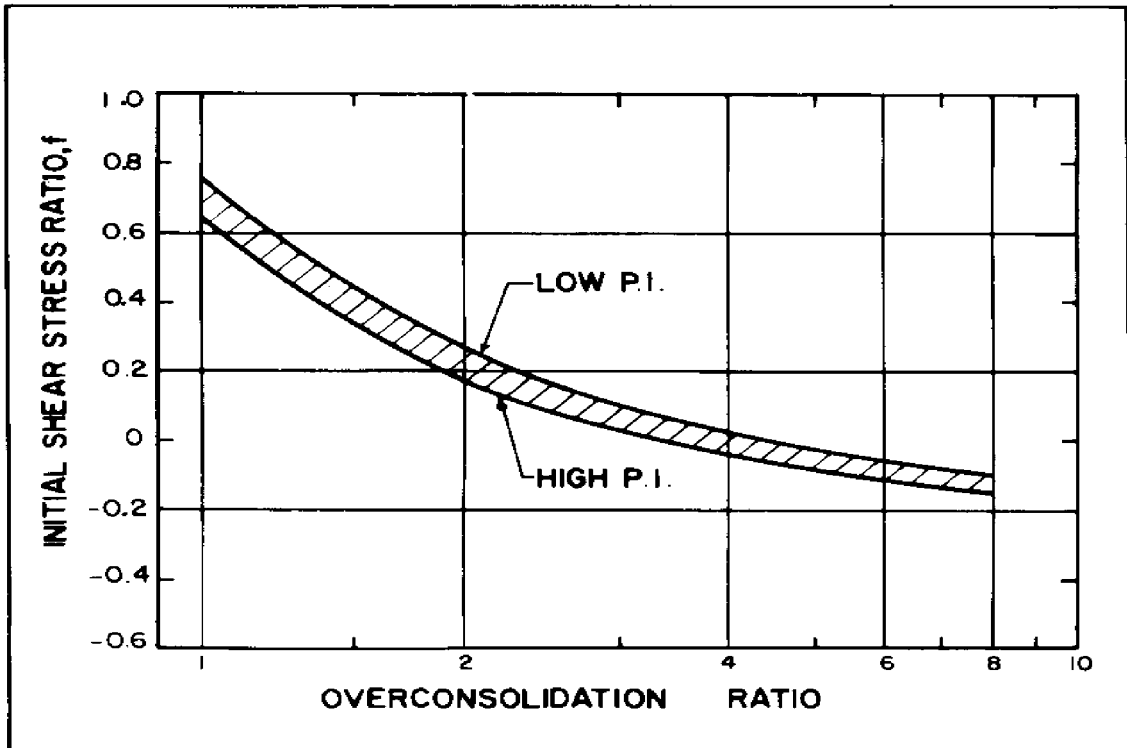

FIGURE 4b  
 Relationship Between Initial Shear Stress and Overconsolidation Ratio

```

+))))))))))))))))))))))))))))))))))))))))))))))))))))))))))))))))))))))))))))))))))-,
* Example:
*
*           Given LL = 58%           PI = 25%           c = 1 KSF
*
* Moderately consolidated clay, OCR <3
*
* Depth to rigid layer (H) = 10.5 ft
*
* [gamma] = 0.5
*
* Rigid strip footing, width = 7 ft   q+appl, = 2.5 KSF   q+ult, = 6 KSF
*
* Find immediate settlement.
*
*           (1-[gamma]+2,)
* [delta]+v, = qB )))))))))))))))))) I
*           E+u,
*
*       I = 2.0 (Table 1) assume length/width [approximately] 10
*
*       From Table 2, E+u, /c = 600
*
*       E+u, = 600 x 1 = 600 KSF
*
*           2.5 x 7 x (1-0.5.2-) x 2.0
* [delta]+v, = )))))))))))))))))))) x 12 = 0.52 inches
*           600
*
* Find factor of safety against bearing failure.
*
*           6.0
* F+S, = ))) = 2.4, 2.4 < 3.0
*           2.5
*
* Correct for yield.
*
*       f = 0.7 (Figure 4b)
*
*       q+appl, /q+ult, = 0.42,   H/B = 1.5
*
*       SR = 0.60 (Figure 4a)
*
* Corrected value of initial settlement
*
*           0.52
* [delta]+c, = ))) = 0.87 inches
*           0.60
.))))))))))))))))))))))))))))))))))))))))))))))))))))))))))))))))))))))))))))))))))-

```

FIGURE 5  
Example of Immediate Settlement Computations in Clay

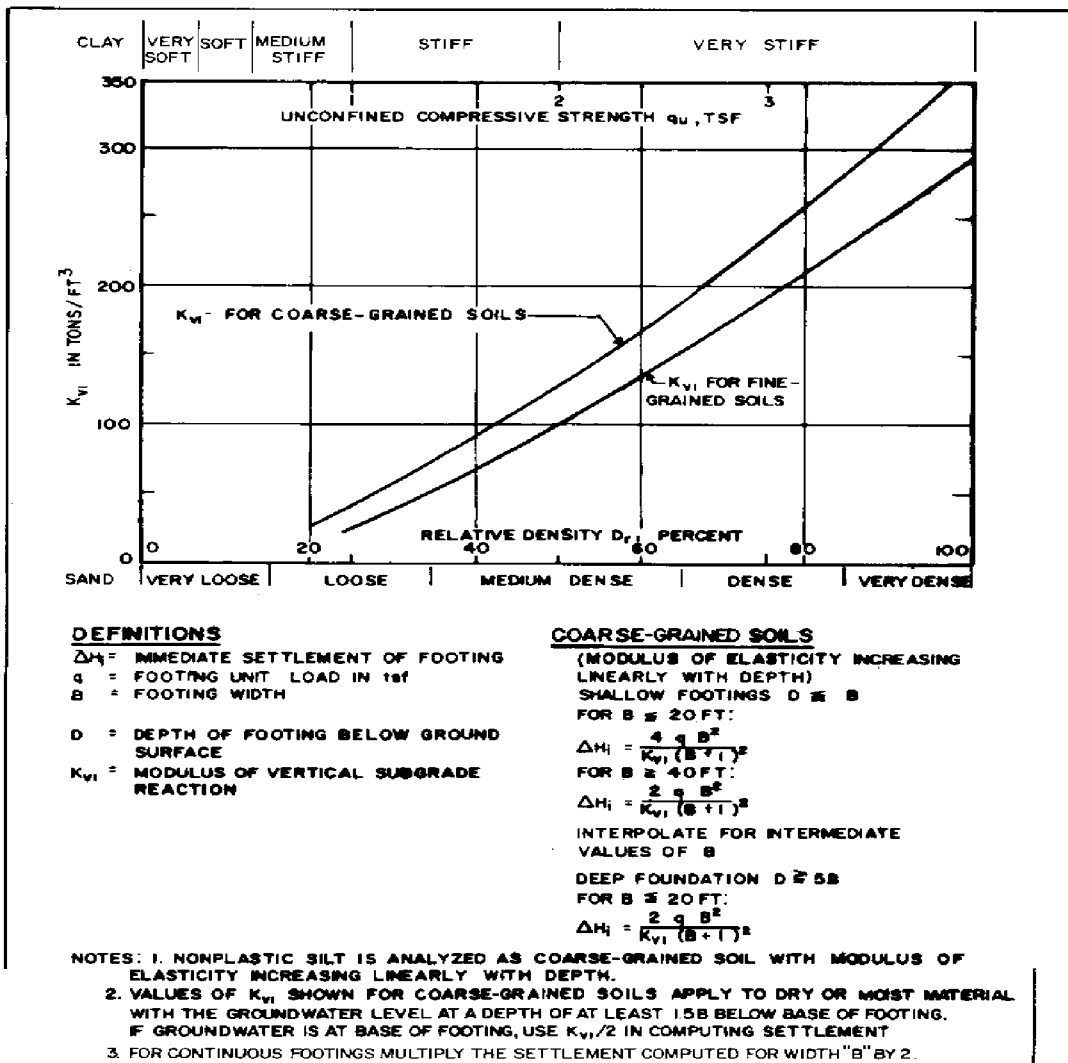

FIGURE 6  
 Instantaneous Settlement of Isolated Footings on Coarse-Grained Soils

+))  
 \*DATA REQUIRED: \*  
 \* \*  
 \*1. A profile of standard penetration resistance N (blows/ft) versus depth, \*  
 \* from the proposed foundation level to a depth of 2B, or to boundary of \*  
 \* an incompressible layer, whichever occurs first. Value of soil modulus \*  
 \* E+s, is established using the following relationships. \*  
 \* \*  

Soil Type	E+s, /N
Silts, sands silts, slightly cohesive silt-sand mixtures	4
Clean, fine to med, sands & slightly silty sands	7
Coarse sands & sands with little gravel	10
Sandy gravels and gravel	12

 \* \*  
 \*2. Least width of foundation = B, depth of embedment = D, and \*  
 \* proposed average contact pressure = P. \*  
 \* \*  
 \*3. Approximate unit weights of surcharge soils, and position of water \*  
 \* table if within D. \*  
 \* \*  
 \*4. If the static cone bearing value  $q+c$ , measured compute  $E+s$ , based on \*  
 \*  $E+s = 2 q+c$ , . \*  
 \* \*  
 \*ANALYSIS PROCEDURE: \*  
 \* \*  
 \*Refer to table in example problem for column numbers referred to by \*  
 \* parenthesis: \*  
 \* \*  
 \*1. Divide the subsurface soil profile into a convenient number of layers \*  
 \* of any thickness, each with constant N over the depth interval 0 to 2B \*  
 \* below the foundation. \*  
 \* \*  
 \*2. Prepare a table as illustrated in the example problem, using the \*  
 \* indicated column headings. Fill in columns 1, 2, 3 and 4 with the \*  
 \* layering assigned in Step 1. \*  
 \* \*  
 \*3. Multiply N values in column 3 by the appropriate factor  $E+s, /N$  (col. 4) \*  
 \* to obtain values of  $E+s, ;$  place values in column 5. \*  
 \* \*  
 \*4. Draw an assumed  $2B-0.6$  triangular distribution for the strain influence \*  
 \* factor  $I+z, ,$  along a scaled depth of 0 to 2B below the foundation. \*  
 \* Locate the depth of the mid-height of each of the layers assumed in \*  
 \* Step 2, and place in column 6. From this construction, determine the \*  
 \*  $I+z,$  value at the mid-height of each layer, and place in column 7. \*  
 \* ))-

FIGURE 7  
 Settlement of Footings Over Granular Soils: Example Computation  
 Using Schmertmann's Method

5. Calculate  $(I_z/E_s) \Delta Z$ , and place in column 8. Determine the sum of all values in column 8.

6. Total settlement =  $\Delta H = C_1 C_2 \Delta p \sum_0^{2B} \left( \frac{I_z}{E_s} \right) \Delta Z$ ,

where  $C_1 = 1 - 0.5 (p_0/\Delta p)$ ;  $C_1 \leq 0.5$       embedment correction factor

$C_2 = 1 + 0.2 \log (10t)$       creep correction factor

$p_0$  = overburden pressure at foundation level

$\Delta p$  = net foundation pressure increase

$t$  = elapsed time in years.

**EXAMPLE PROBLEM:**

GIVEN THE FOLLOWING SOIL SYSTEM AND CORRESPONDING STANDARD PENETRATION TEST (SPT) DATA, DETERMINE THE AMOUNT OF ULTIMATE SETTLEMENT UNDER A GIVEN FOOTING AND FOOTING LOAD:

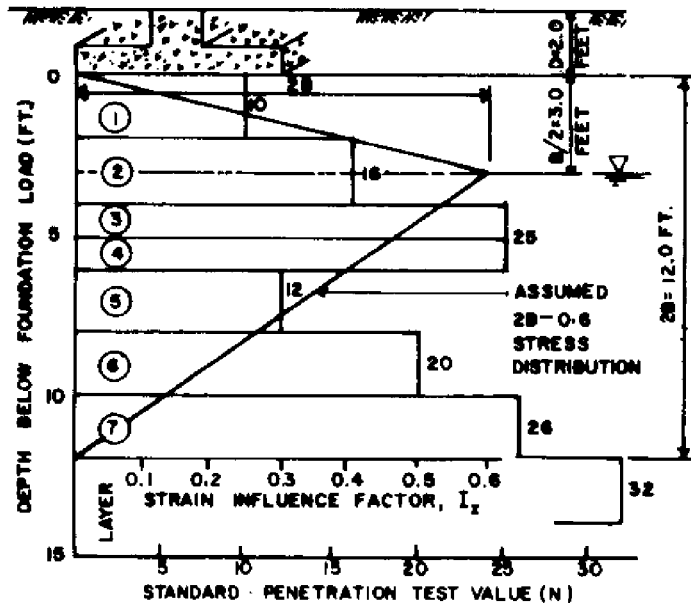

FIGURE 7 (continued)  
Settlement of Footings Over Granular Soils:  
Example Computation Using Schmertmann's Method



Footing Details:

Footing width: 6.0 ft. (min.) by 8.0 ft. (max.)

Depth of Embedment: 2.0 ft. Load (Dead + Live): 120 tons

Soil Properties:

Depth Below Surface (ft.)	Depth Below Base of Footing (ft.)	Unit Wt. (pcf)		Soil Description
		Moist	Sat.	
0 - 5	<5	95	105	Fine sandy silt
5 - 10	3 - 8	105	120	Fine to medium sand
10 - 17	8 - 15	120	130	Coarse sand

Solution:

Layer (1)	$\Delta Z$ (in.) (2)	N (3)	$E_s/N$ (4)	$E_s$ (tsf) (5)	$Z_c$ (in.) (6)	$I_z$ (7)	$\frac{I_z}{E_s} \Delta Z$ (in./tsf) (8)
1	24	10	4	40	12	.20	0.120
2	24	16	4	64	36	.60	0.225
3	12	25	4	100	54	.50	0.060
4	12	25	7	175	66	.43	0.029
5	24	12	7	84	84	.33	0.094
6	24	20	7	140	108	.20	0.034
7	24	26	10	260	132	.07	0.006

$$\Sigma = 0.568$$

$$p_0 = (2.0 \text{ ft})(95 \text{ pcf}) = 190 \text{ psf} = 0.095 \text{ tsf}$$
$$\Delta p = 120 \text{ tons}/(6 \text{ ft.})(8 \text{ ft.}) = 2.50 \text{ tsf}$$

At  $t = 1$  yr,

$$C_1 = 1 - 0.5(.095/2.50) = 0.981$$

$$C_2 = 1 + 0.2 \log (10)(1) = 1.20$$

$$\Delta H = (0.981)(1.20)(2.50)(0.568) = \underline{1.67 \text{ in.}}$$

FIGURE 7 (continued)  
Settlement of Footings Over Granular Soils:  
Example Computation Using Schmertmann's Method

## Section 4. PRIMARY AND SECONDARY SETTLEMENTS

### 1. PRIMARY CONSOLIDATION.

a. Consolidation Settlement. For conditions where excess pore pressures are developed during the application of load and if preconsolidation stress is determined reliably, total settlement can be predicted with reasonable accuracy. The percentage error is greatest for settlement from recompression only. In this case an overestimate may result unless high quality undisturbed samples are used for consolidation tests.

(1) Typical Loading Cycle. See Figure 3 for loading sequence in building construction. Foundation excavation can cause swell and heave. Application of a structural load recompresses subsoil and may extend consolidation into the virgin compression range. Stress changes are plotted on a semilogarithmic pressure-void ratio e-log p curve similar to that shown in Figure 3.

(2) Pressure-Void Ratio Diagram. Determine the appropriate e-log p curve to represent average properties of compressible stratum from consolidation tests. The e-log p curve may be interpreted from straight line virgin compression and recompression slopes intersecting at the preconsolidation stress. Draw e-log p curve to conform to these straight lines as shown in Figure 3.

(3) Magnitude of Consolidation Settlement. Compute settlement magnitude from change in void ratio corresponding to change in stress from initial to final conditions, obtained from the e-log p curve (Figure 3). To improve the accuracy of computations divide the clay layer into a number of sublayers for computing settlement. Changes in compressibility of the stratum and existing and applied stresses can be dealt with more accurately by considering each sublayer independently and then finding their combined effect.

(4) Preliminary estimates of C+c, can be made using the correlations in Table 3.

b. Corrections to Magnitude of Consolidation Settlements. Settlements computed for overconsolidated clays by the above procedures may give an overestimate of the settlement. Correct consolidation settlement estimate as follows:

$$H+c, =[\alpha] ([W-DELTA]H)+oc,$$

H+c, = corrected consolidation settlement

[alpha] = function of overconsolidation ratio (OCR) and the width of loaded area and thickness of compressible stratum (See Figure 8 for values and Reference 6, Estimating Consolidation Settlements of Shallow Foundation on Overconsolidated Clay, by Leonards.)

TABLE 3  
 Estimates of Coefficient of Consolidation (C+c,)

```

+)))))))))))))))))))))))))))))))))))))))))))))))))))))))))))))))))))))))))))))))))))))))))))*,
*
*   C+c, = 0.009 (LL - 10%) inorganic soils, with sensitivity less than 4 *
*
*   C+c, = 0.0115 w+n, organic soils, peat *
*
*   C+c, = 1.15 (e+o, - 0.35) all clays *
*
*   C+c, = (1 + e+o,)(0.1 + [w+n, - 25] 0.006) varved clays *
*
*w+n, is natural moisture content, LL is water content at liquid limit and *
*e+o, is initial void ratio. *
.)))))))))))))))))))))))))))))))))))))))))))))))))))))))))))))))))))))))))))))))))))))))))))-
  
```

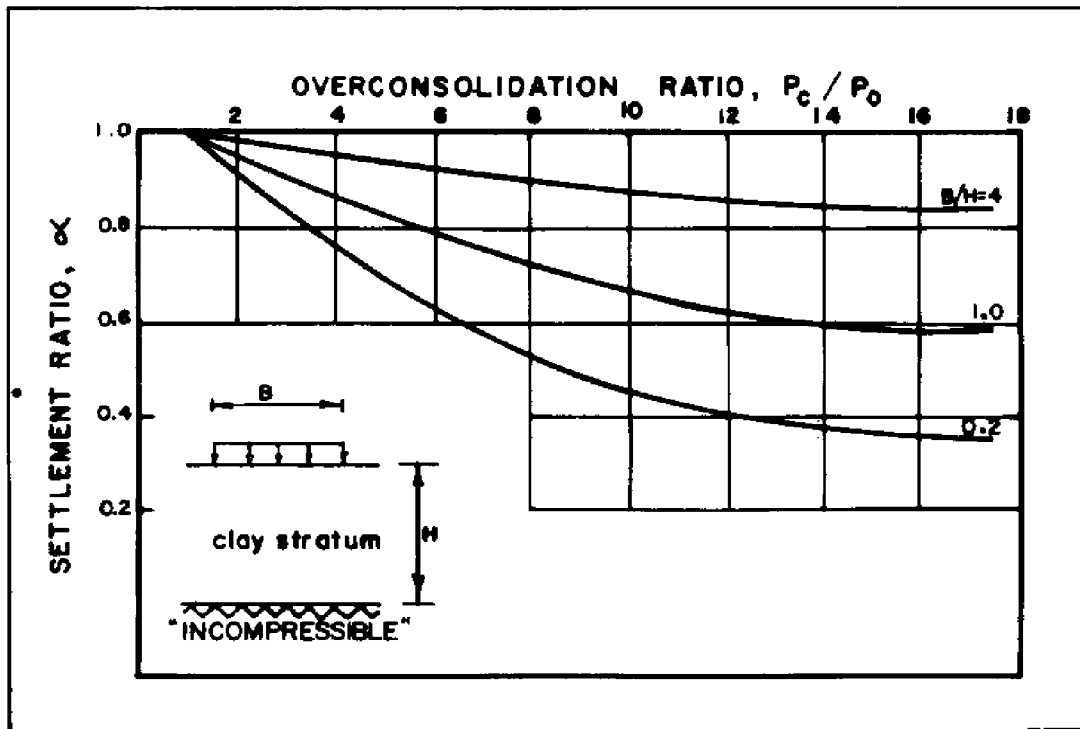

FIGURE 8  
Relation Between Settlement Ratio and Overconsolidation Ratio

OCR = preconsolidation pressure/overburden pressure  
( $P+c, /P+o,$ ) (See Chapter 3.)

$([W-DELTA]H)+oc,$  = calculated settlement resulting from stress increment of  $P+o,$  to  $P+c,$  by procedures outlined in Figure 3, Section 2.

## 2. TIME RATE OF PRIMARY CONSOLIDATION.

a. Application. Settlement time rate must be determined for foundation treatment involving either acceleration of consolidation or preconsolidation before construction of structure. Knowledge of settlement rate or percent consolidation completed at a particular time is important in planning remedial measures on a structure damaged by settlement.

b. Time Rate of Consolidation. Where pore water drainage is essentially vertical, the ordinary one dimensional theory of consolidation defines the time rate of settlement. Using the coefficient of consolidation  $c_v,$  compute percent consolidation completed at specific elapsed times by the time factor  $T_v,$  curves of Figure 9 (upper panel, Reference 7, Soils and Geology, Procedures for Foundation Design of Buildings and Other Structures (Except Hydraulic Structures), by the Departments of the Army and Air Force). For vertical sand drains use Figure 10 (upper panel, Reference 7). For preliminary estimates, the empirical correlation for  $c_v,$  in Chapter 3 may be used.

(1) Effect of Pressure Distribution. Rate of consolidation is influenced by the distribution of the pressures which occur throughout the depth of the compressible layer. For cases where the pressures are uniform or vary linearly with depth, use Figure 9 which includes the most common pressure distribution. The nomograph in Figure 11 may be used for this case.

For nonlinear pressure distribution, use Reference 8, Soil Mechanics in Engineering Practice, by Terzaghi and Peck, to obtain the time factor.

(2) Accuracy of Prediction. Frequently the predicted settlement time is longer than that observed in the field for the following reasons:

(a) Theoretical conditions assumed for the consolidation analysis frequently do not hold in situ because of intermediate lateral drainage, anisotropy in permeability, time dependency of real loading, and the variation of soil properties with effective stress. Two or three dimensional loading increases the time rate of consolidation. Figure 12 (after Reference 9, Stress Deformation and Strength Characteristics, by Ladd et al.) gives examples of how the width of the loaded area and anisotropy in permeability can affect the consolidation rate substantially. As the ratio of the thickness of the compressible layer to the width of the loaded area increases, the theory tends to overestimate the time factor. For deposits such as some horizontal varved clays where continuous seams of high permeability are present, consolidation can be expected to be considerably faster than settlement rates computed based on the assumption of no lateral drainage.

(b) The coefficient of consolidation, as determined in the laboratory, decreases with sample disturbance. Predicted settlement time tends to be greater than actual time (see Chapter 3).

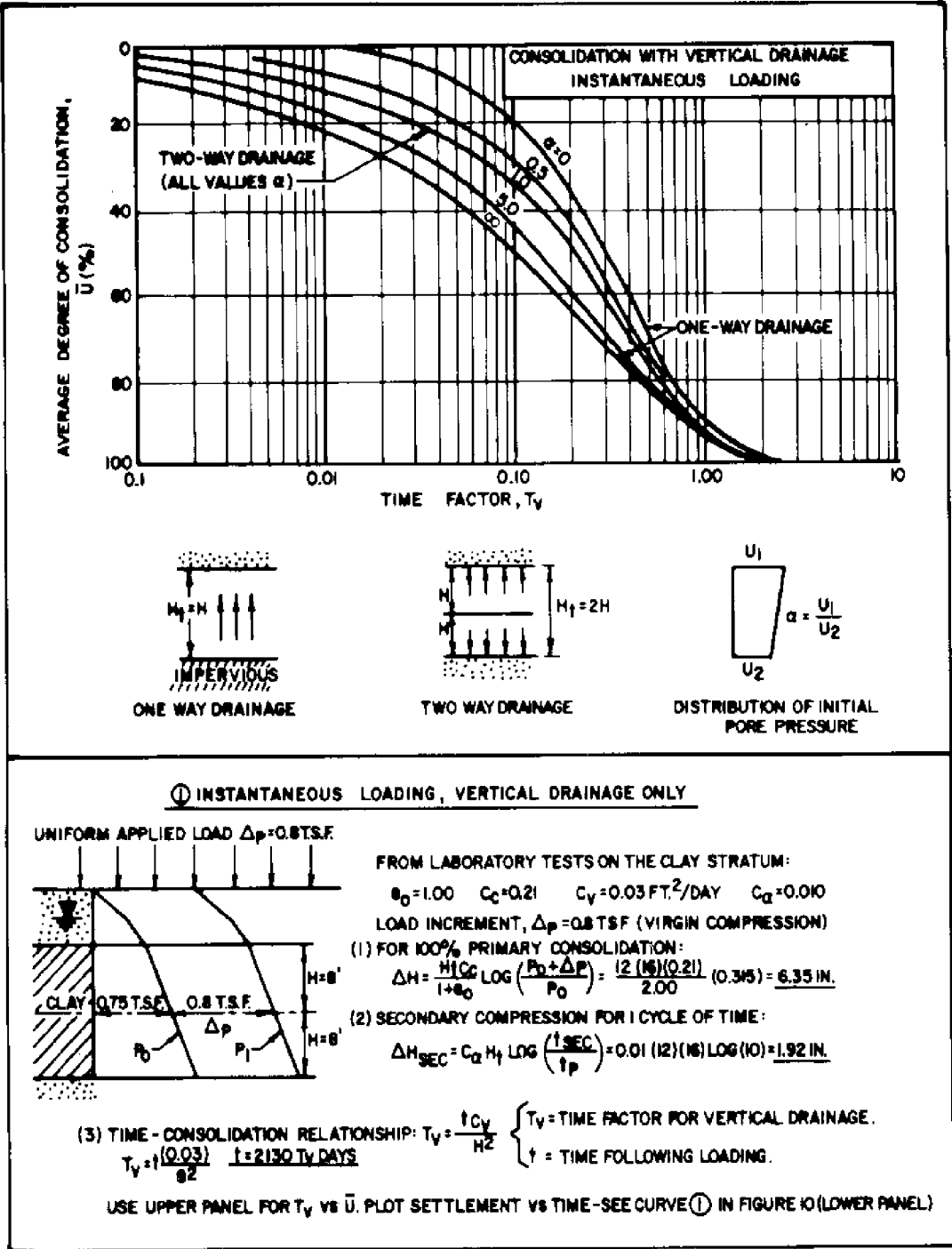

FIGURE 9  
 Time Rate of Consolidation for Vertical Drainage  
 Due to Instantaneous Loading

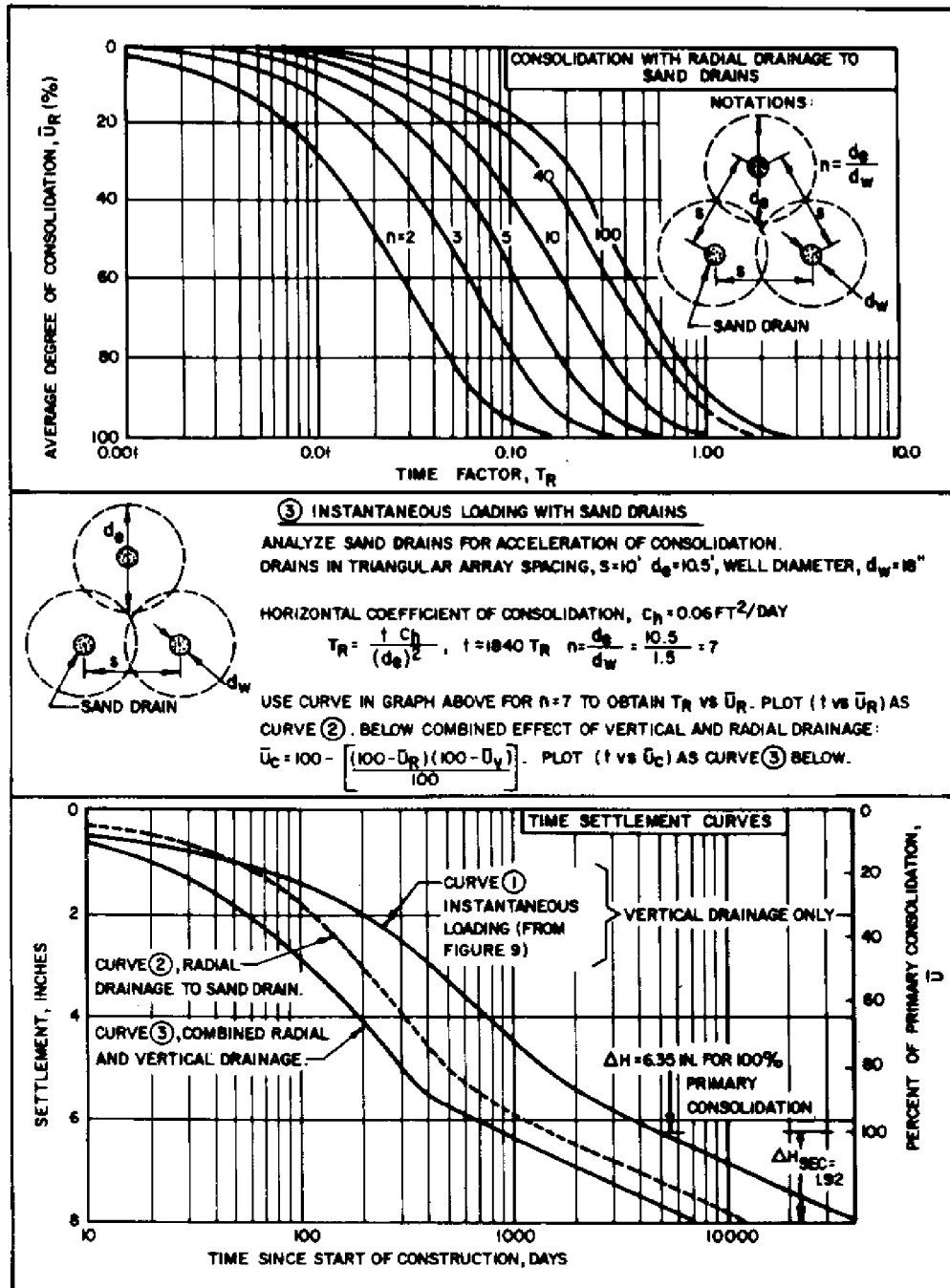

FIGURE 10  
Vertical Sand Drains and Settlement Time Rate  
7.1-228

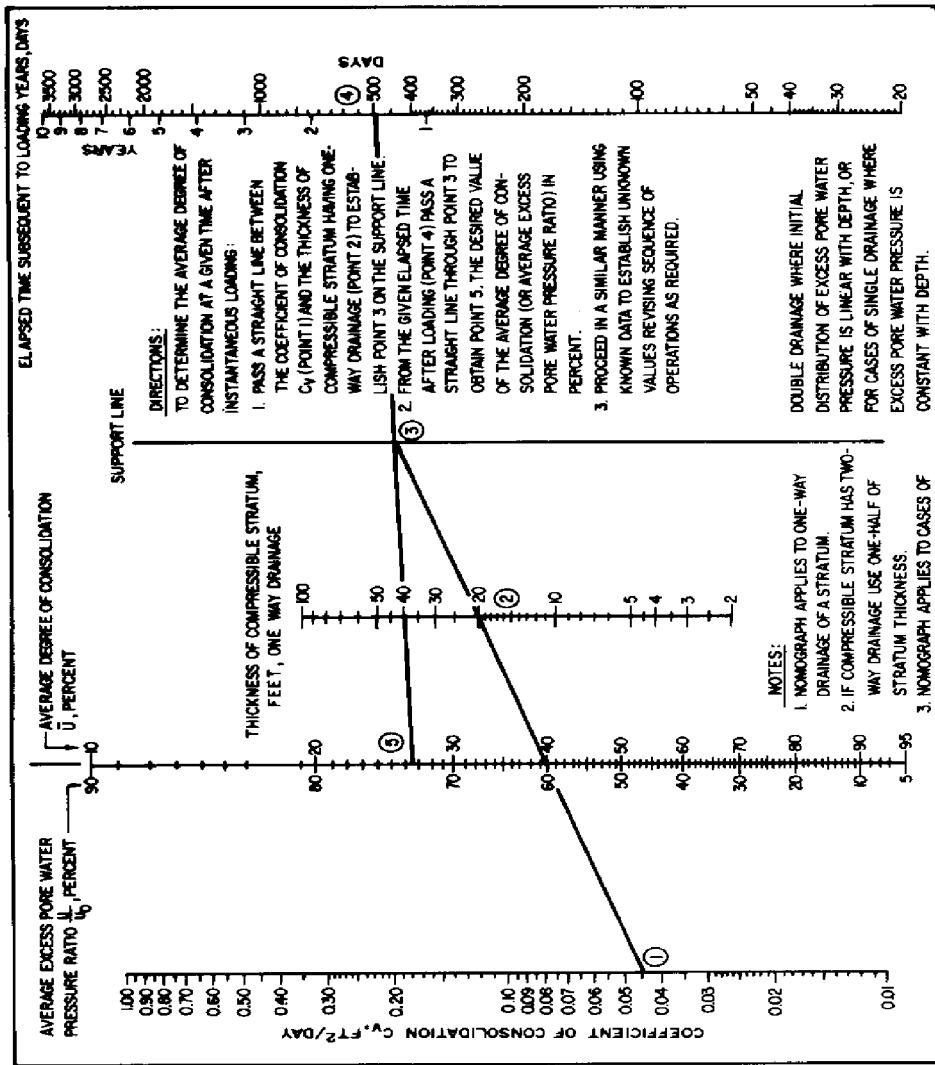
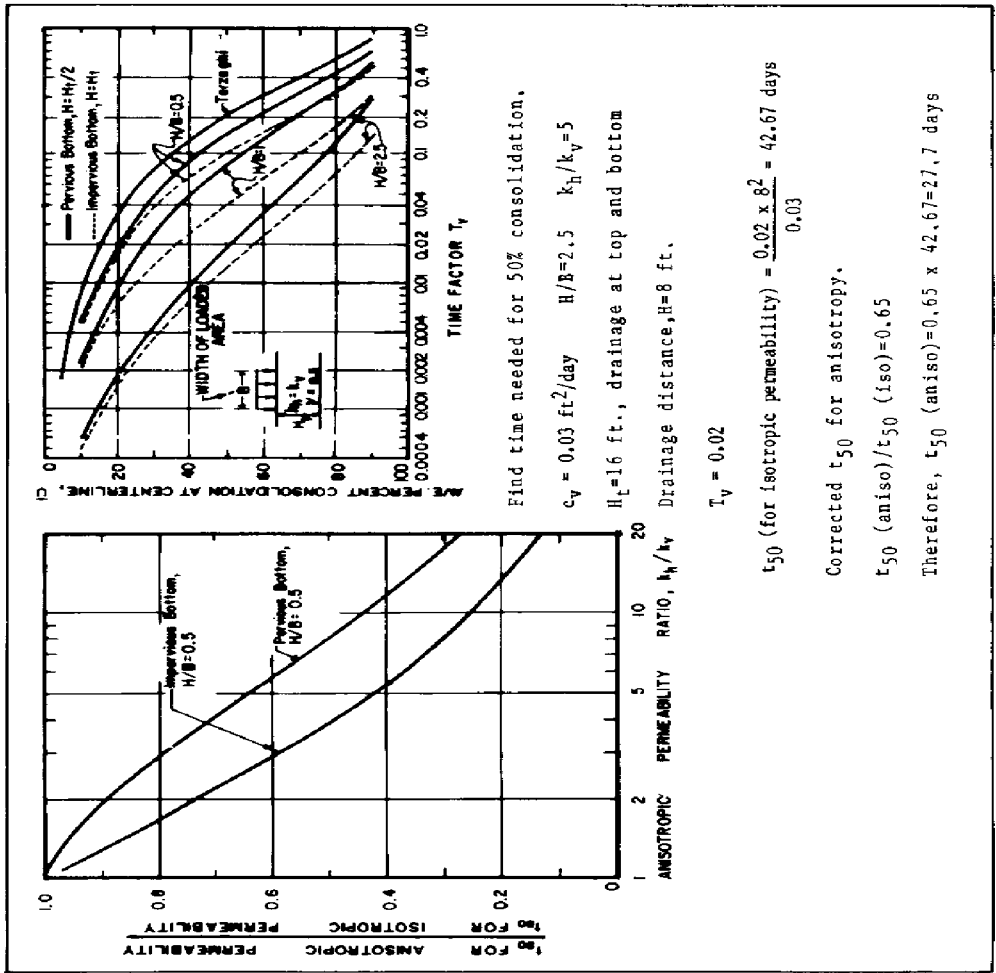

FIGURE 11  
Nomograph for Consolidation With Vertical Drainage





Find time needed for 50% consolidation,

$$c_v = 0.03 \text{ ft}^2/\text{day} \quad H/B = 2.5 \quad k_h/k_v = 5$$

$H_t = 16$  ft., drainage at top and bottom

Drainage distance,  $H = 8$  ft.

$$T_v = 0.02$$

$$t_{50} \text{ (for isotropic permeability)} = \frac{0.02 \times 8^2}{0.03} = 42.67 \text{ days}$$

Corrected  $t_{50}$  for anisotropy,

$$t_{50} \text{ (aniso)}/t_{50} \text{ (iso)} = 0.65$$

Therefore,  $t_{50} \text{ (aniso)} = 0.65 \times 42.67 = 27.7$  days

FIGURE 12  
Effect of Drainage Conditions on Time Rate of Consolidation

(3) Gradual Load Application. If construction time is appreciable compared to time required for primary consolidation, use the time factors of Figure 13 (Reference 10, Consolidation Under Time Dependent Loading, by Olson) to determine consolidation rate during and following construction.

(4) Coefficient of Consolidation From Field Measurements. Where piezometers are installed to measure pore water pressure under the applied loads,  $c_v$ , is computed as shown in Figure 14.

c. Time Rate of Multi-Layer Consolidation. If a compressible stratum contains layers of different overall properties, use the procedure of Figure 15 to determine overall settlement time rate.

### 3. SECONDARY COMPRESSION.

a. Laboratory e-log p Curve. A laboratory e-log p curve includes an amount of secondary compression that depends on duration of test loads. Secondary compression continues exponentially with time without definite termination. Thus, total or ultimate settlement includes secondary compression to a specific time following completion of primary consolidation.

b. Settlement Computation. Compute settlement from secondary compression following primary consolidation as follows:

$$H_{+sec} = C + [\alpha] \left( \frac{H_{+t}}{t_p} \right) \log \left( \frac{t_{+sec}}{t_p} \right)$$

$H_{+sec}$ , = settlement from secondary compression

$C + [\alpha]$ , = coefficient of secondary compression  
expressed by the strain per log cycle of time  
(See Chapter 3)

$H_{+t}$ , = thickness of the compressible stratum

$t_{+sec}$ , = useful life of structure or time  
for which settlement is significant

$t_p$ , = time of completion of primary consolidation

See example in Figure 9 for calculating the secondary settlement. The parameter C can be determined from laboratory consolidation tests (Chapter 3); for preliminary estimates, the correlations in Figure 16 (after Reference 2) may be used. This relationship is applicable to a wide range of soils such as inorganic plastic clays, organic silts, peats, etc.

c. Combining Secondary and Primary Consolidation. If secondary compression is important, compute the settlement from primary consolidation separately, using an e-log p curve that includes only compression from primary consolidation. For each load increment in the consolidation test, compression is plotted versus time (log scale) (see Chapter 3). The compression at the end of the primary portion (rather than standard 24 hours) may be used to establish e-log p curve.

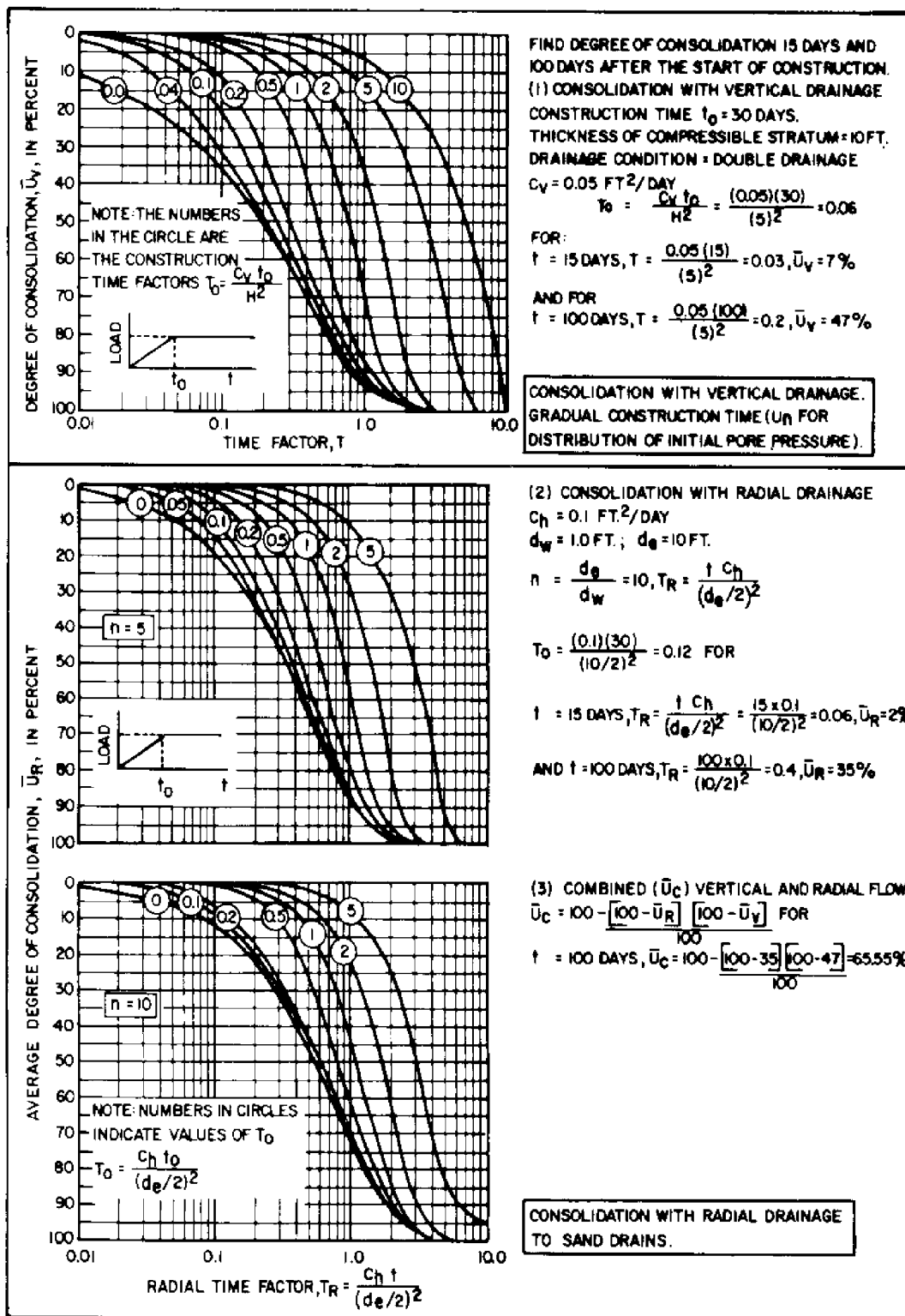

FIGURE 13  
Time Rate of Consolidation for Gradual Load Application

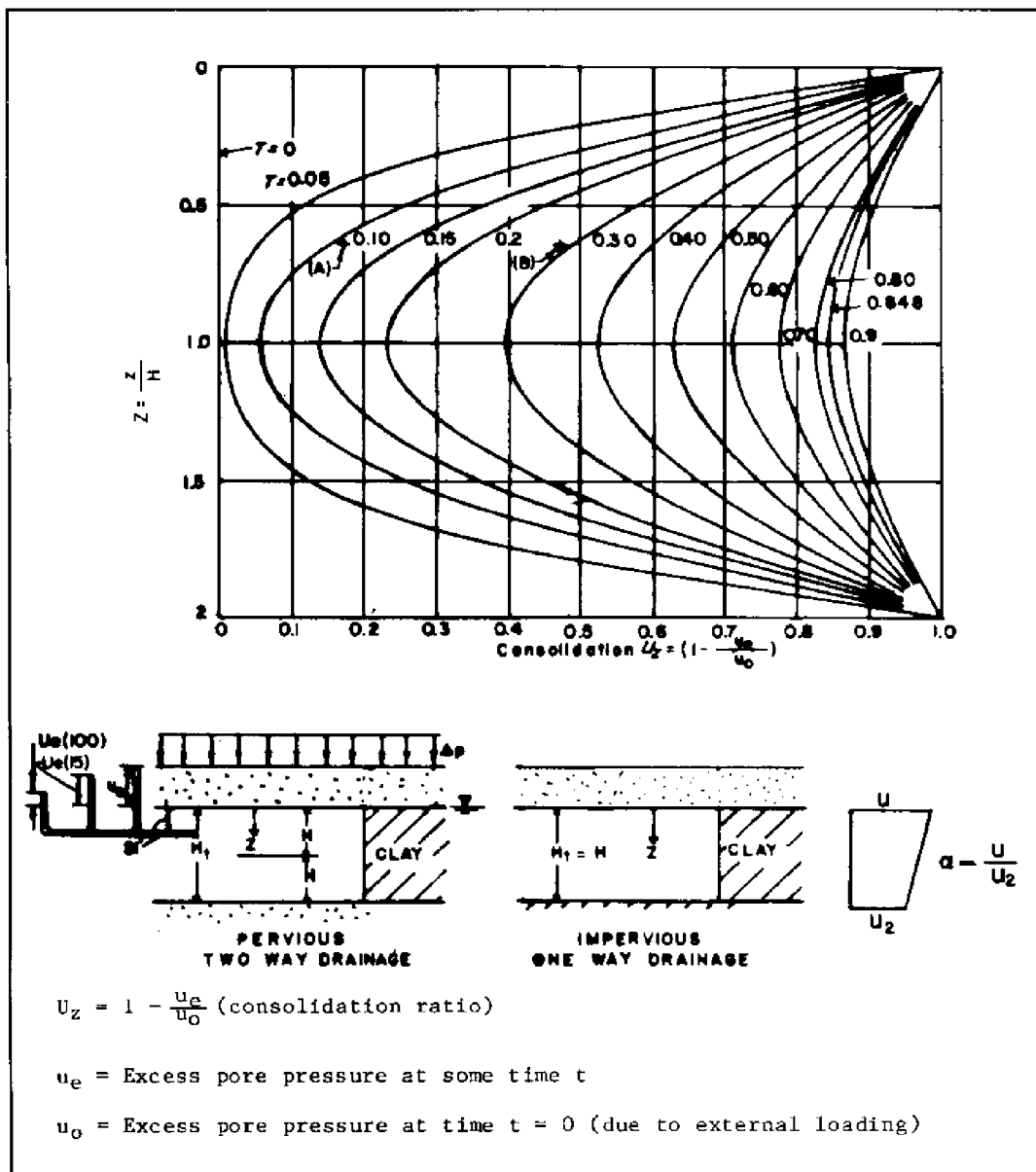

FIGURE 14  
Coefficient of Consolidation from Field Measurements

```

+))))))))))
* Example:
*
* Thickness of clay layer H+t, = 66 ft, Drainage - top & bottom
*
* H = 66/2 = 33 ft
*
* Depth of piezometer below top of compressible layer = 21 ft
*
* Applied external load [W-DELTA]p = 1.5 KSF
*
* Initial excess pore water pressure = u+o, = [W-DELTA]p = 1.5 KSF
*
* Excess pore pressure after time t+1, = 15 days, u+e,(15) = 20 ft = U+et1,
*
* Excess pore pressure after time t+2, = 100 days, u+e,(100) = 14 ft = U+et2,
*
* Piezometer measure U+o, = 24 feet of water +21 ft (initial static head)
* for a total of 45 ft.
*
* Z 21
* ) = )) = 0.64,
* H 33
*
* Consolidation ratio at time t+1, = 15 days = (u+z,)t+1, = 1 - 20/24 = 0.17
*
* Consolidation ratio at time t+2, = 100 days = (u+2,)t+2, = 1 - 14/24 = 0.47
*
* From above graph T+t1, = 0.11 (point A), T+t2, = 0.29 (point B)
*
*          0.29 - 0.11
* C+v, = ))))))) x (33).2- = 231 ft.2-/day
*          100 - 15
*
.))))))))))

```

FIGURE 14 (continued)  
 Coefficient of Consolidation from Field Measurements



EXAMPLE OF COMPUTATION OF RATE OF CONSOLIDATION FOR A MULTI-LAYERED SYSTEM:

LAYERED SYSTEM:

ACTUAL STRATIFICATION

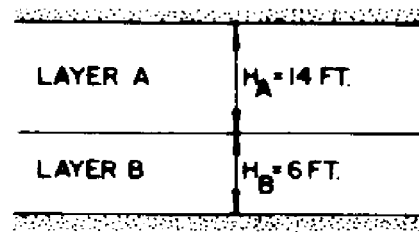

EQUIVALENT STRATIFICATION

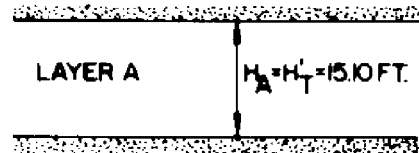

KNOWN APPLICABLE SOIL PROPERTIES:

LAYER A:

$$c_{vA} = 0.04 \text{ FT.}^2/\text{DAY}$$

LAYER B:

$$c_{vB} = 1.20 \text{ FT.}^2/\text{DAY}$$

ASSUME: DOUBLE DRAINAGE

DETERMINATION OF EQUIVALENT LAYER THICKNESS:

1. ASSUME AN EQUIVALENT LAYER POSSESSING THE PROPERTIES OF SOIL A.

$$\begin{aligned} 2. \text{ EQUIVALENT THICKNESS } H_T' &= H_A + H_B \left( \frac{c_{vA}}{c_{vB}} \right)^{1/2} \\ &= H_A + H_B \left( \frac{0.04}{1.20} \right)^{1/2} \\ &= 14 + 6 \left( \frac{0.04}{1.20} \right)^{1/2} \\ &= 14 + 1.10 \\ H_T' &= 15.10 \text{ FT.} \end{aligned}$$

3. DETERMINE  $\bar{U}$  FROM FIGURE 11, e.g. AT  $t = 0.25$  YEARS, USING  $H = (15.10)/2 = 7.55 \text{ FT.}$  (DRAINAGE PATH ASSUMING DOUBLE DRAINAGE) AND  $c_{vA} = 0.04 \text{ FT.}^2/\text{DAY}$ ,  $\bar{U} = 29.1\%$

FIGURE 15 (continued)  
Procedure for Determining the Rate of Consolidation  
for All Soil Systems Containing "N" Layers

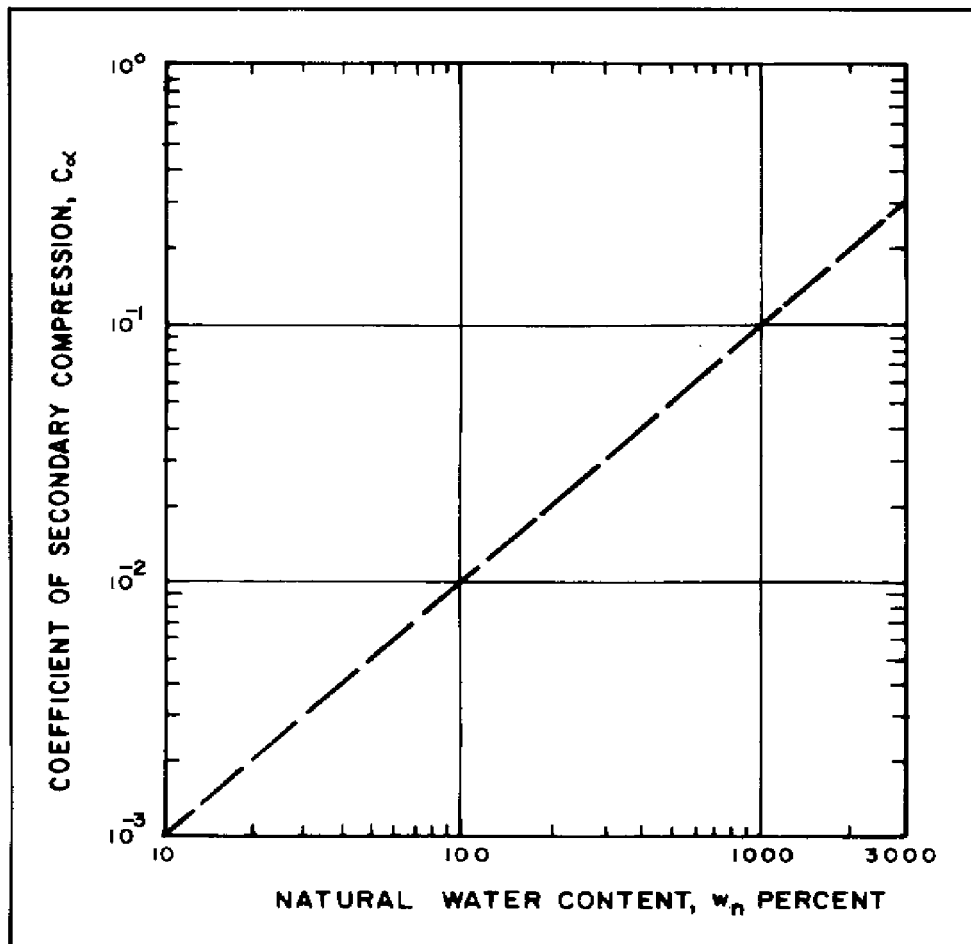

FIGURE 16  
Coefficient of Secondary Compression as Related to  
Natural Water Content



4. SANITARY LANDFILL. Foundations on sanitary landfills will undergo extensive settlements, both total and distortional, which are extremely difficult to predict. Settlements result not only from compression of the underlying materials, but also from the decomposition of organic matter. Gases in landfill areas are health and fire hazards. A thorough study is necessary when utilizing sanitary landfill areas for foundations. Further guidance is given in DM-7.3, Chapter 3.

5. PEAT AND ORGANIC SOILS. Settlements in these soils are computed in a similar manner as for fine-grained soils. However, the primary consolidation takes place rapidly and the secondary compression continues for a long period of time and contributes much more to the total settlement.

#### Section 5. TOLERABLE AND DIFFERENTIAL SETTLEMENT

1. APPLICATIONS. For an important structure, compute total settlement at a sufficient number of points to establish the overall settlement pattern. From this pattern, determine the maximum scope of the settlement profile or the greatest difference in settlement between adjacent foundation units.

2. APPROXIMATE VALUES. Because of natural variation of soil properties and uncertainty on the rigidity of structure and thus actual loads transmitted to foundation units, empirical relationships have been suggested to estimate the differential settlements (or angular distortion) in terms of total settlement (see Reference 11, Structure Soil Interaction, by Institution of Civil Engineers). Terzaghi and Peck (Reference 8, page 489) suggested that for footings on sand, differential settlement is unlikely to exceed 75% of the total settlement. For clays, differential settlement may in some cases approach the total settlement.

#### 3. TOLERABLE SETTLEMENT

a. Criteria. Differential settlements and associated rotations and tilt may cause structural damage and could impair the serviceability and function of a given structure. Under certain conditions, differential settlements could undermine the stability of the structure and cause structural failure. Table 4 (Reference 12, Allowable Settlements of Structures, by Bjerrum) provides some guidelines to evaluate the effect of settlement on most structures. Table 5 provides guidelines for tanks and other facilities.

b. Reduction of Differential Settlement Effects. For methods of reducing or accelerating consolidation settlements, see Section 6. Settlement that can be completed during the early stages of construction, before placing sensitive finishes, generally will not contribute to structural distress. In buildings with light frames where large differential settlements may not harm the frame, make special provisions to avoid damage to utilities or operating equipment. Isolate sensitive equipment, such as motor-generator sets within the structure, on separate rigidly supported foundations. Provide flexible couplings for utility lines at critical locations.

TABLE 4  
Tolerable Settlements for Building

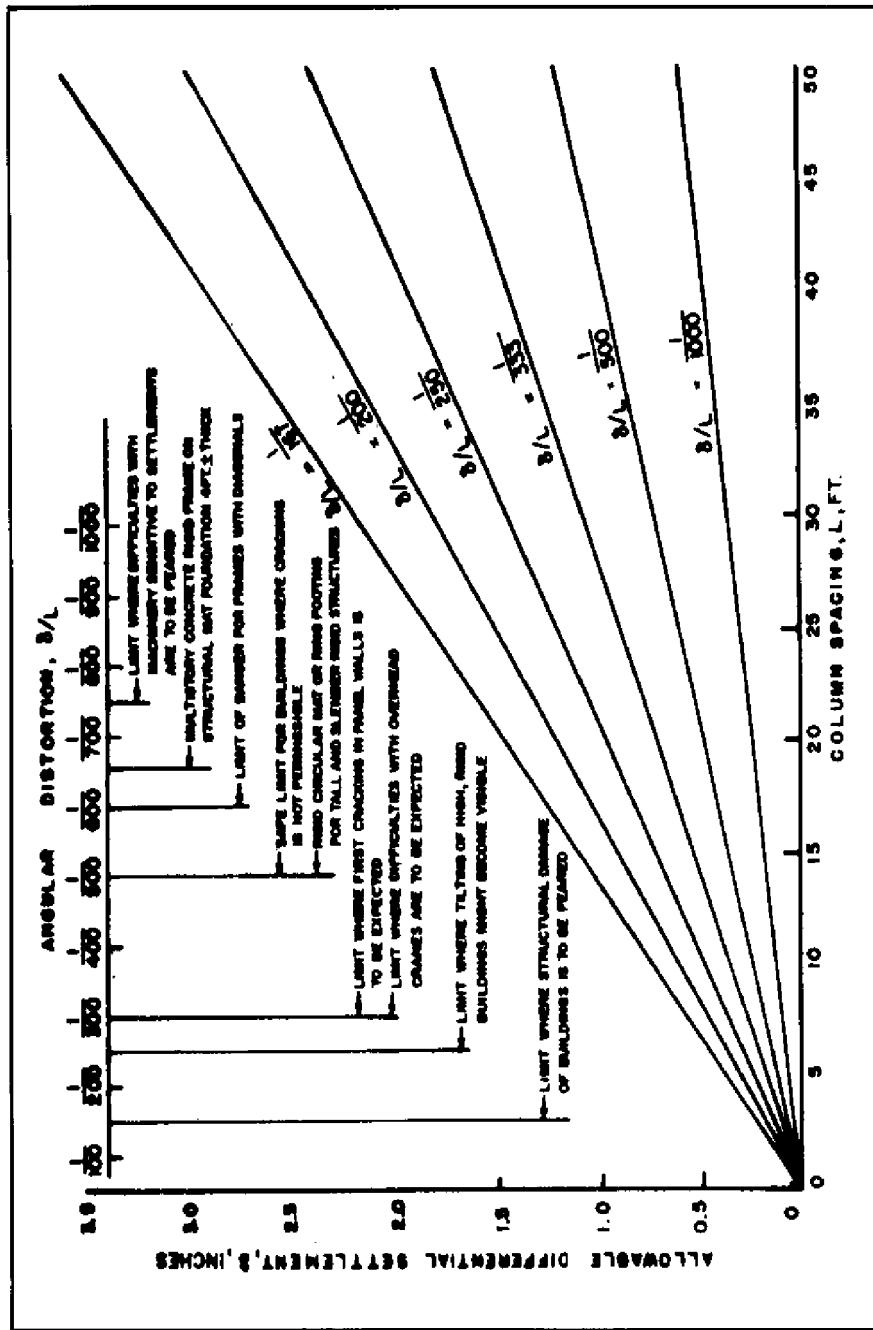
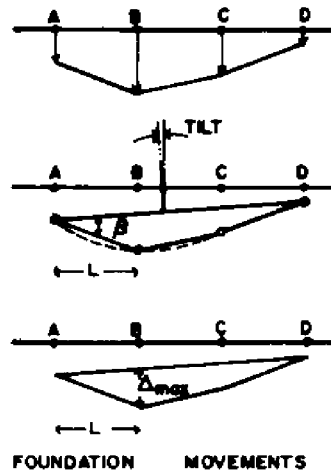
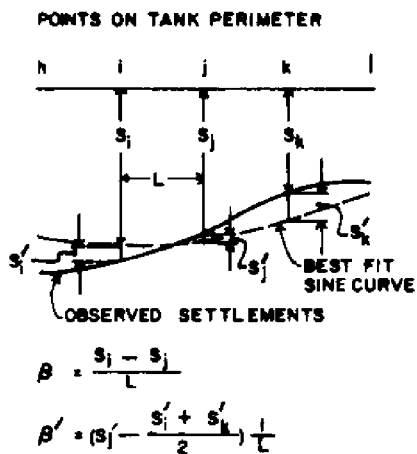

TABLE 5  
Tolerable Differential Settlement for Miscellaneous Structures

STRUCTURE	TOLERABLE DISTORTION $\frac{\Delta_{max}}{L}$ or $\beta$
<p>A. UNREINFORCED LOAD BEARING WALLS</p> <p>(L and H are respectively length and height of the wall from top of footing)</p> <p>SAGGING FOR L/H &lt; 3</p> <p>HOBBLING FOR L/H &gt; 5</p> <p>FOR L/H = 1</p> <p>FOR L/H = 5</p>	<p><math>\frac{\Delta_{max}}{L} = 1/3500</math> to <math>1/2500</math></p> <p><math>\frac{\Delta_{max}}{L} = 1/2000</math> to <math>1/1250</math></p> <p><math>\frac{\Delta_{max}}{L} = 1/5000</math></p> <p><math>\frac{\Delta_{max}}{L} = 1/2500</math></p>
<p>B. JOINTED RIGID CONCRETE PRESSURE CONDUITS (MAXIMUM ANGLE CHANGE AT JOINT 2 TO 4 TIMES AVERAGE SLOPE OF SETTLEMENT PROFILE. LONGITUDINAL EXTENSION AFFECTS DAMAGE.)</p>	<p>1/85</p>
<p>C. CIRCULAR STEEL PETROLEUM OR FLUID STORAGE TANKS.</p>	<p><math>\beta &lt; 1/300</math></p> <p><math>\beta' = 1/500</math> to <math>1/300</math></p>



4. EFFECT OF STRUCTURE RIGIDITY. Computed differential settlement is less accurate than computed total or average settlement because the interaction between the foundation elements and the supporting soil is difficult to predict. Complete rigidity implies uniform settlement and thus no differential settlement. Complete flexibility implies uniform contact pressure between the mat and the soil. Actual conditions are always in between the two extreme conditions. However, depending on the magnitude of relative stiffness as defined below, mats can be defined as rigid or flexible for practical purposes.

a. Uniformly Loaded Circular Raft. In the case where the raft has a frictionless contact with an elastic half space (as soil is generally assumed to represent), the relative stiffness is defined as

[retrieve Equation]

R = radius of the raft, t = thickness of raft, subscripts r and s refer to raft and soil, [upsilon] = Poisson's ratio and E = Young's modulus.

For  $K+r, < / = 0.08$ , raft is considered flexible and for  $K+r, < / = 5.0$  raft is considered rigid.

For intermediate stiffness values see Reference 13, Numerical Analyses of Uniformly Loaded Circular Rafts on Elastic Layers of Finite Depth, by Brown.

b. Uniformly Loaded Rectangular Raft. For frictionless contact between the raft and soil, the stiffness factor is defined as:

[retrieve Equation]

B = width of the foundation. Other symbols are defined in (a).

For  $K+r, < / = 0.05$ , raft is considered flexible and for  $K+r, > / = 10$ , raft is considered rigid.

For intermediate stiffness values see Reference 14, Numerical Analysis of Rectangular Raft on Layered Foundations, by Frazer and Wardle.

#### Section 6. METHODS OF REDUCING OR ACCELERATING SETTLEMENT

1. GENERAL. See Table 6 for methods of minimizing consolidation settlements. These include removal or displacement of compressible material and preconsolidation in advance of final construction.

2. REMOVAL OF COMPRESSIBLE SOILS. Consider excavation or displacement of compressible materials for stabilization of fills that must be placed over soft strata.

TABLE 6  
 Methods of Reducing or Accelerating Settlement or Coping with Settlement

Method	Comment
*Procedures for linear fills on swamps or compressible surface stratum:	
*Excavation of soft material...	* When compressible foundation soils extend to depth of about 10 to 15 ft, it may be practicable to remove entirely. Partial removal is combined with various methods of displacing remaining soft material.
*Displacement by weight of fill.	* Complete displacement is obtained only when compressible foundation is thin and very soft. Weight displacement is combined with excavation of shallow material.
*Jetting to facilitate displacement.....	* For a sand or gravel fill, jetting within the fill reduces its rigidity and promotes shear failure to displace soft foundation. Jetting within soft foundation weakens it to assist in displacement.
*Blasting by trench or shooting methods.....	* Charge is placed directly in front of advancing fill to blast out a trench into which the fill is forced by the weight of surcharge built up at its point. Limited to depths not exceeding about 20 ft.
*Blasting by relief method.....	* Used for building up fill on an old roadway or for fills of plastic soil. Trenches are blasted at both toes of the fill slopes, relieving confining pressure and allowing fill to settle and displace underlying soft materials.
*Blasting by underfill method...	* Charge is placed in soft soil underlying fill by jetting through the fill at a preliminary stage of its buildup. Blasting loosens compressible material, accelerating settlement and facilitating displacement to the sides. In some cases relief ditches are cut or blasted at toe of the fill slopes. Procedure is used in swamp deposits up to 30 ft thick.

TABLE 6 (continued)  
 Methods of Reducing or Accelerating Settlement or Coping with Settlement

Method	Comment
*Procedures for preconsolidation*	
*of soft foundations:	
* Surcharge fill.....	*Used where compressible stratum is relatively thin and sufficient time is available for consolidation under surcharge load. Surcharge material may be placed as a stockpile for use later in permanent construction. Soft foundation must be stable against shear failure under surcharge load.
*Accelerating consolidation by vertical drains.....	*Used where tolerable settlement of the completed structure is small, where time available for preconsolidation is limited, and surcharge fill is reasonably economical. Soft foundation must be stable against shear failure under surcharge load.
*Vertical sand drains with or without surcharge fill.....	*Used to accelerate the time for consolidation by providing shorter drainage paths.
*Wellpoints placed in vertical sand drains.....	*Used to accelerate consolidation by reducing the water head, thereby permitting increased flow into the sand drains. Particularly useful where potential instability of soft foundation restricts placing of surcharge or where surcharge is not economical.
*Vacuum method.....	*Variation of wellpoint in vertical sand drain but with a positive seal at the top of the sand drain surrounding the wellpoint pipe. Atmospheric pressure replaces surcharge in consolidating soft foundations.
*Balancing load of structure by excavation.....	*Utilized in connection with mat or raft foundations on compressible material or where separate spread footings are founded in suitable bearing material overlying compressible stratum. Use of this method may eliminate deep foundations, but it requires very thorough analysis of soil compressibility and heave.

a. Removal by Excavation. Organic swamp deposits with low shear strength and high compressibility should be removed by excavation and replaced by controlled fill. Frequently these organic soils are underlain by very loose fine sands or silt or soft clayey silts which may be adequate for the embankment foundation and not require replacement.

Topsoil is usually stripped prior to placement of fills; however, stripping may not be required for embankments higher than 6 feet as the settlement from the upper 1/2 foot of topsoil is generally small and takes place rapidly during construction period. However, if the topsoil is left in place, the overall stability of the embankment should be checked assuming a failure plane through the topsoil using the methods of Chapter 7.

b. Displacement. Partial excavation may be accompanied by displacement of the soft foundation by the weight of fill. The advancing fill should have a steep front face. The displacement method is usually used for peat and muck deposits. This method has been used successfully in a few cases for soft soils up to 65 feet deep. Jetting in the fill and various blasting methods are used to facilitate displacement. Fibrous organic materials tend to resist displacement resulting in trapped pockets which may cause differential settlement.

3. BALANCING LOAD BY EXCAVATION. To decrease final settlement, the foundation of heavy structures may be placed above compressible strata within an excavation that is carried to a depth at which the weight of overburden, removed partially or completely, balances the applied load.

a. Computation of Total Settlement. In this case, settlement is derived largely from recompression. The amount of recompression is influenced by magnitude of heave and magnitude of swell in the unloading stage.

b. Effect of Dewatering. If drawdown for dewatering extends well below the planned subgrade, heave and consequent recompression are decreased by the application of capillary stresses. If groundwater level is restored after construction, the load removed equals the depth of excavation times total unit weight of the soil. If groundwater pressures are to be permanently relieved, the load removed equals the total weight of soil above the original water table plus the submerged weight of soil below the original water table. Calculate effective stresses as described in Figure 2, and consolidation under structural loads as shown in Figure 3.

4. PRECONSOLIDATION BY SURCHARGE. This procedure causes a portion of the total settlement to occur before construction. It is used primarily for fill beneath paved areas or structures with comparatively light column loads. For heavier structures, a compacted fill of high rigidity may be required to reduce stresses in compressible foundation soil (see DM-7.2, Chapter 2).

a. Elimination of Primary Consolidation. Use Figure 17 to determine surcharge load and percent consolidation under surcharge necessary to eliminate primary consolidation under final load. This computation assumes that the rate of consolidation under the surcharge is equal to that under final load.

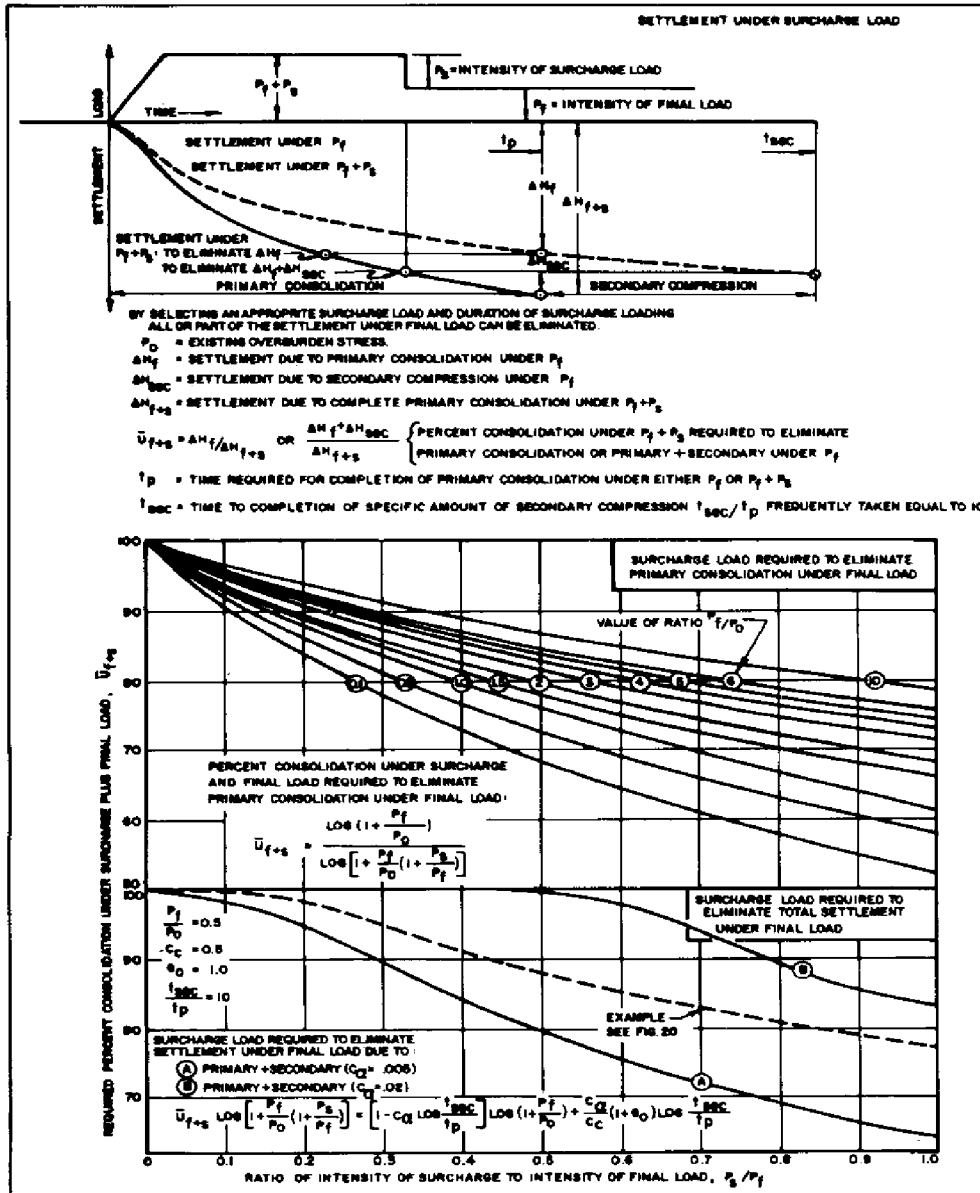

FIGURE 17  
Surcharge Load Required to Eliminate Settlement Under Final Load



b. Elimination of Secondary Consolidation. Use the formula in the bottom panel of Figure 17 to determine surcharge load and percent consolidation under surcharge required to eliminate primary consolidation plus a specific secondary compression under final load.

c. Limitations on Surcharge. In addition to considerations of time available and cost, the surcharge load may induce shear failure of the soft foundation soil. Analyze stability under surcharge by methods of Chapter 7.

5. VERTICAL DRAINS. These consist of a column of pervious material placed in cylindrical vertical holes in the compressible stratum at sufficiently close spaces so that the horizontal drainage path is less than the vertical drainage path. All drains should be connected at the ground surface to a drainage blanket. Vertical drains are utilized in connection with fills supporting pavements or low- to moderate-load structures and storage tanks. Common types of vertical drains are shown in Table 7 (Reference 15, Use of Precompression and Vertical Sand Drains for Stabilization of Foundation Soils, by Ladd). Sand drains driven with a closed-end pipe produce the largest displacement and disturbance in the surrounding soil and thus their effectiveness is reduced.

a. Characteristics. Vertical drains accelerate consolidation by facilitating drainage of pore water but do not change total compression of the stratum subjected to a specific load. Vertical drains are laid out in rows, staggered, or aligned to form patterns of equilateral triangles or squares. See Figure 18 for cross-section and design data for typical installation for sand drains.

b. Consolidation Rate. Time rate of consolidation by radial drainage of pore water to vertical drains is defined by time factor curves in upper panel of Figure 10. For convenience, use the nomograph of Figure 19 to determine consolidation time rate. Determine the combined effect of vertical and radial drainage on consolidation time rate as shown in the example in Figure 10.

c. Vertical Drain Design. See Figure 20 for an example of design. For a trial selection of drain diameter and spacing, combine percent consolidation at a specific time from vertical drainage with percent consolidation for radial drainage to the drain. This combined percent consolidation  $U+c$ , is plotted versus elapsed time for different drain spacing in the center panel of Figure 20. Selection of drain spacing depends on the percent consolidation required prior to start of structure, the time available for consolidation, and economic considerations.

d. Allowance for Smear and Disturbance. In cases where sand drain holes are driven with a closed-end pipe, soil in a surrounding annular space one-third to one-half the drain diameter in width is remolded and its stratification is distorted by smear. Smear tends to reduce the horizontal permeability coefficient, and a correction should be made in accordance with Figure 21.

TABLE 7  
Common Types of Vertical Drains

General Type	Sub-type	Typical Installation	
		$d_w$	s
1. Driven Sand Drain	Closed end mandrel	18 <sup>+</sup> in	5 - 20 ft
2. Augered Sand Drain	(a) Screw type auger	6 - 30 in	-
	(b) Continuous flight hollow stem auger	18 in	5 - 20 ft
3. Jetted Sand Drain	(a) Internal jetting	18 in	5 - 20 ft
	(b) Rotary jet	12 - 18 in	5 - 20 ft
	(c) Dutch jet-bailer	12 in	4 - 16 ft
4. "Paper" Drain	(a) Kjellman cardboard wick	0.1 <sup>+</sup> in by 4 <sup>+</sup> in	1.5 <sup>+</sup> - 4 <sup>+</sup> ft
	(b) Cardboard coated plastic wick	slightly thicker	-
5. Fabric Encased Sand Drain	(a) Sandwich	2.5 - 3 in	4 - 12 ft
	(b) Fabridrain	5 in	-

$d_w$  = diameter of drain, s = drain spacing

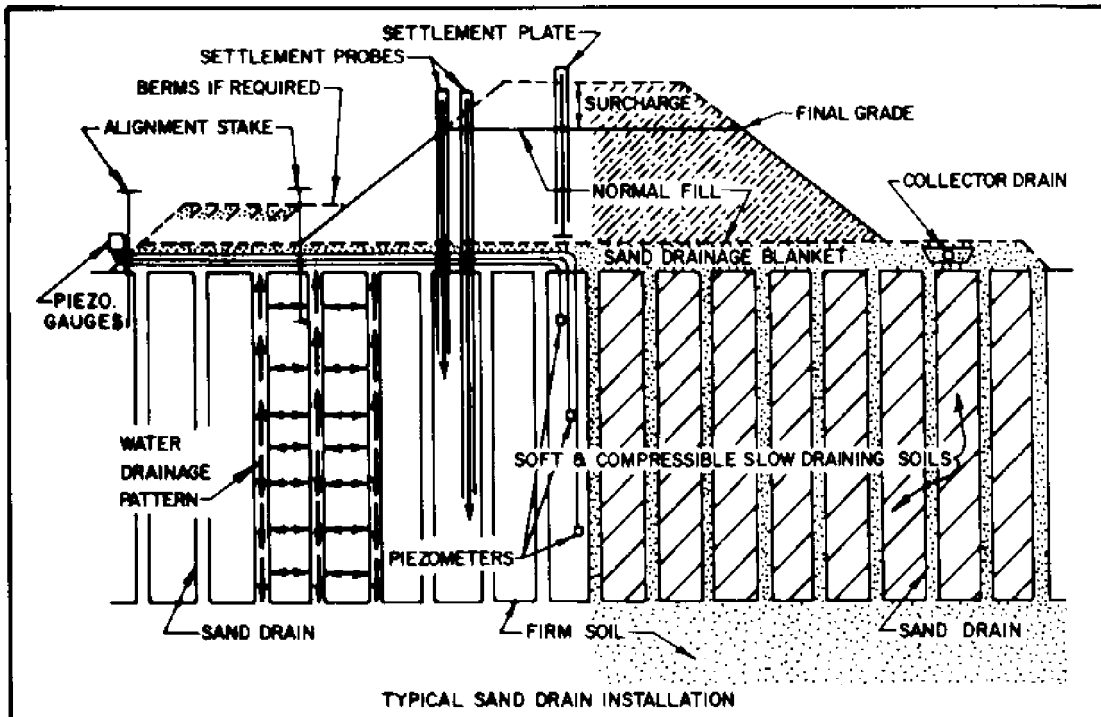

**DIAMETER OF DRAINS** RANGES FROM 6 TO 30 IN., GENERALLY BETWEEN 16 AND 20 IN.  
**SPACING OF DRAINS** RANGES FROM 6 TO 20 FT ON CENTER, GENERALLY BETWEEN 6 AND 10 FT.  
**PRINCIPAL METHODS FOR INSTALLING DRAINS** ARE CLOSED OR OPEN MANDRELS ADVANCED BY DRIVING OR JETTING, OR ROTARY DRILLING WITH OR WITHOUT JETS. DRIVING CLOSED MANDREL IS THE MOST COMMON.  
**DRAIN BACKFILL MATERIAL** SHOULD HAVE SUFFICIENT PERMEABILITY TO DISCHARGE PORE WATER FLOW ANTICIPATED, BUT USUALLY DOES NOT MEET FILTER REQUIREMENTS AGAINST FOUNDATIONS SOILS. CLEAN SANDS WITH NO MORE THAN 3% BY WEIGHT PASSING NO. 200 SIEVE IS USUALLY SUITABLE. A TYPICAL GRADATION IS AS FOLLOWS:

SIEVE No.	4	16	50	100	200
% FINER BY WEIGHT:	90-100	40-85	2-30	0-7	0-3

**SAND DRAINAGE BLANKET** MATERIAL IS SIMILAR TO THAT USED FOR DRAIN BACKFILL. IN SOME CASES GRAVEL WINDROWS OR PERFORATED, CORRUGATED, METAL PIPE ARE PLACED IN DRAINAGE BLANKET TO REDUCE HEAD LOSS IN DRAINAGE BLANKET. LONGITUDINAL DITCH OR COLLECTOR DRAIN MAY BE PLACED AT TOE. GRANULAR WORKING MAT IS SOMETIMES PLACED BELOW DRAINAGE BLANKET TO SUPPORT EQUIPMENT.  
**SURCHARGE** LOAD IS PLACED TO REDUCE OR ELIMINATE POSTCONSTRUCTION CONSOLIDATION BENEATH NORMAL FILL. GENERALLY THE SURCHARGE LOAD IS NO MORE THAN ABOUT 30% OF NORMAL EMBANKMENT LOAD.

**FIELD CONTROL DEVICES:**

- PIEZOMETERS OF STANDPIPE OR CLOSED SYSTEM TYPE TO OBSERVE PORE WATER PRESSURES;
- SETTLEMENT PLATES, MINIMUM 3 FT SQUARE, PLACED AT BASE OF FILL TO RECORD TOTAL SETTLEMENT;
- SETTLEMENT PROBES DRIVEN OR AUGERED INTO FOUNDATION STRATUM TO MEASURE COMPRESSION WITHIN FOUNDATION.
- ALIGNMENT STAKES, T-SHAPED STAKES PLACED AT OR OUTSIDE EMBANKMENT TOE TO OBSERVE LATERAL MOVEMENT AND HEAVE.

FIGURE 18  
 Data for Typical Sand Drain Installation

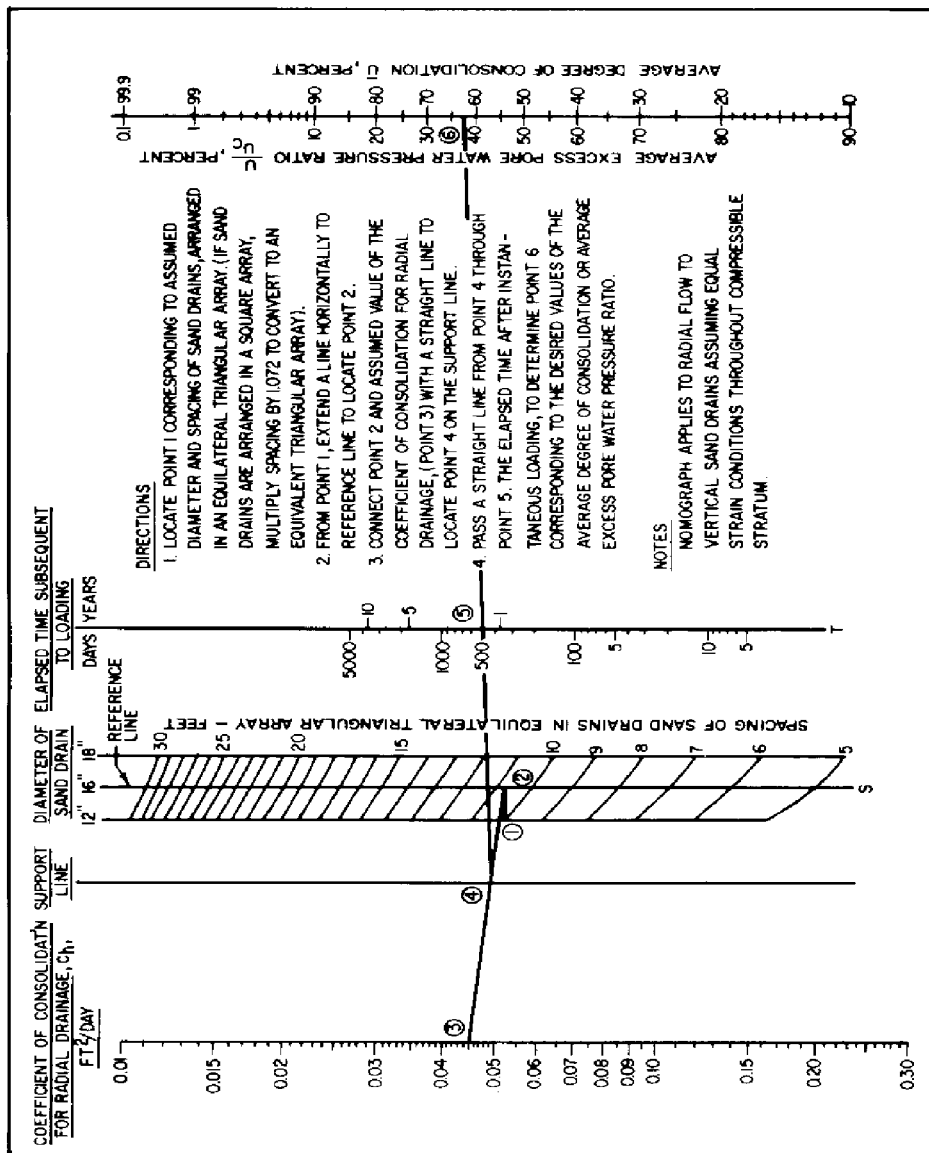

FIGURE 19  
Nomograph for Consolidation with Radial Drainage to Vertical Sand Drain

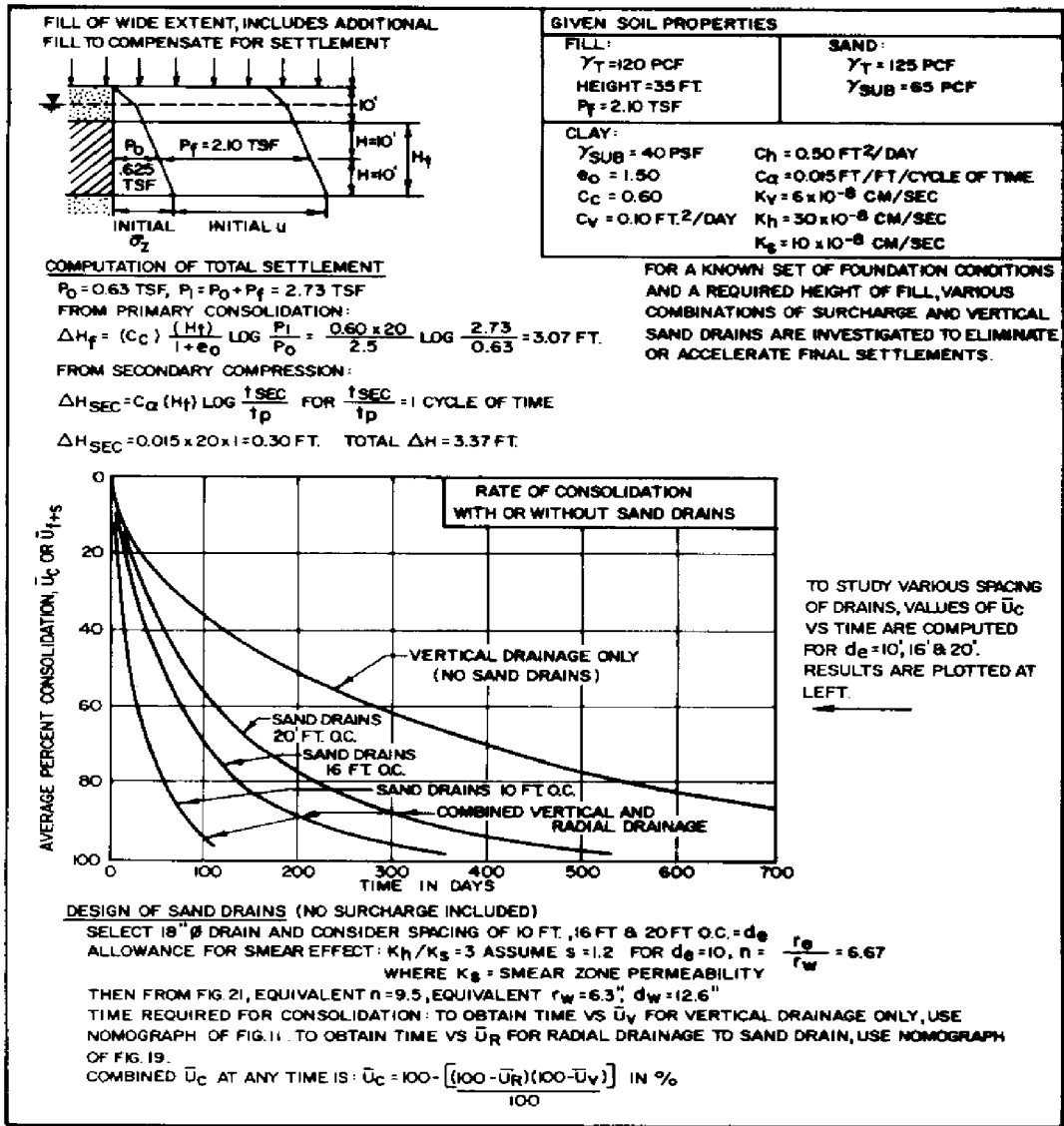
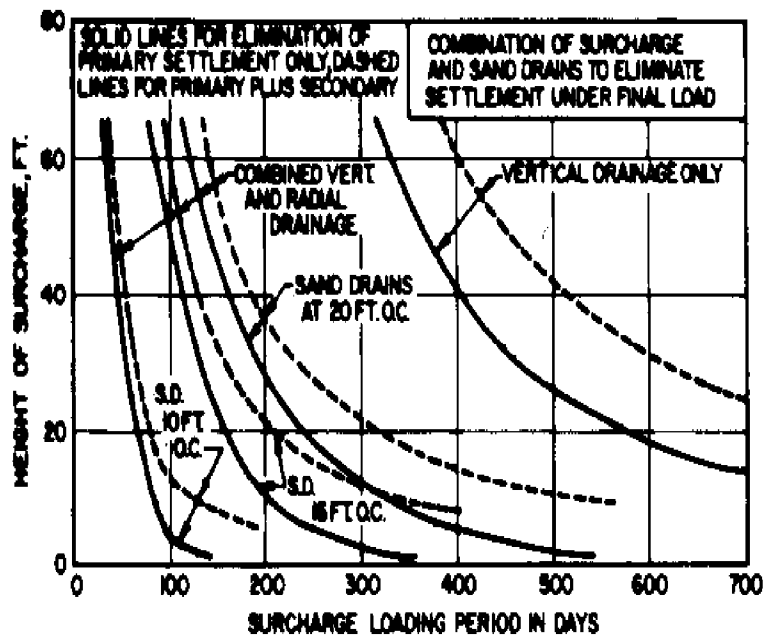

FIGURE 20  
Example of Surcharge and Sand Drain Design



**SELECTION OF SURCHARGE HEIGHT**

$\Delta H_f = 3.07'$ ,  $\Delta H_{SEC} = 0.30'$ ,  $P_f/P_0 = 3.38$

TO ELIMINATE SETTLEMENT UNDER  $P_f$ ,  $\bar{U}_{f+s}$  IS TAKEN EQUAL TO  $\bar{U}_{f+s}$ ,  $\bar{U}_{f+s} = \frac{\Delta H_f}{\Delta H_{f+s}}$  OR  $\frac{\Delta H_f + \Delta H_{SEC}}{\Delta H_{f+s}}$

RELATION OF  $\bar{U}_{f+s}$  AND TIME IS GIVEN ABOVE FOR VARIOUS DRAIN SPACINGS.

SURCHARGE  $P_s$  FOR VALUES OF  $\bar{U}_{f+s} = \frac{\Delta H_f}{\Delta H_{f+s}}$  IS GIVEN IN FIG. 17

SURCHARGE  $P_s$  FOR VALUES OF  $\bar{U}_{f+s} = \frac{\Delta H_f + \Delta H_{SEC}}{\Delta H_{f+s}}$  IS GIVEN BY FORMULA IN FIG. 17

USING THESE RELATIONSHIPS,  $P_s$  (EXPRESSED AS HEIGHT OF SURCHARGE) REPLACES  $\bar{U}_{f+s}$  IN FIGURE 17.

COMBINATION OF SAND DRAIN AND SURCHARGE IS SELECTED BASED ON TIME AVAILABLE AND COMPARATIVE COSTS.

FIGURE 20 (continued)  
Example of Surcharge and Sand Drain Design

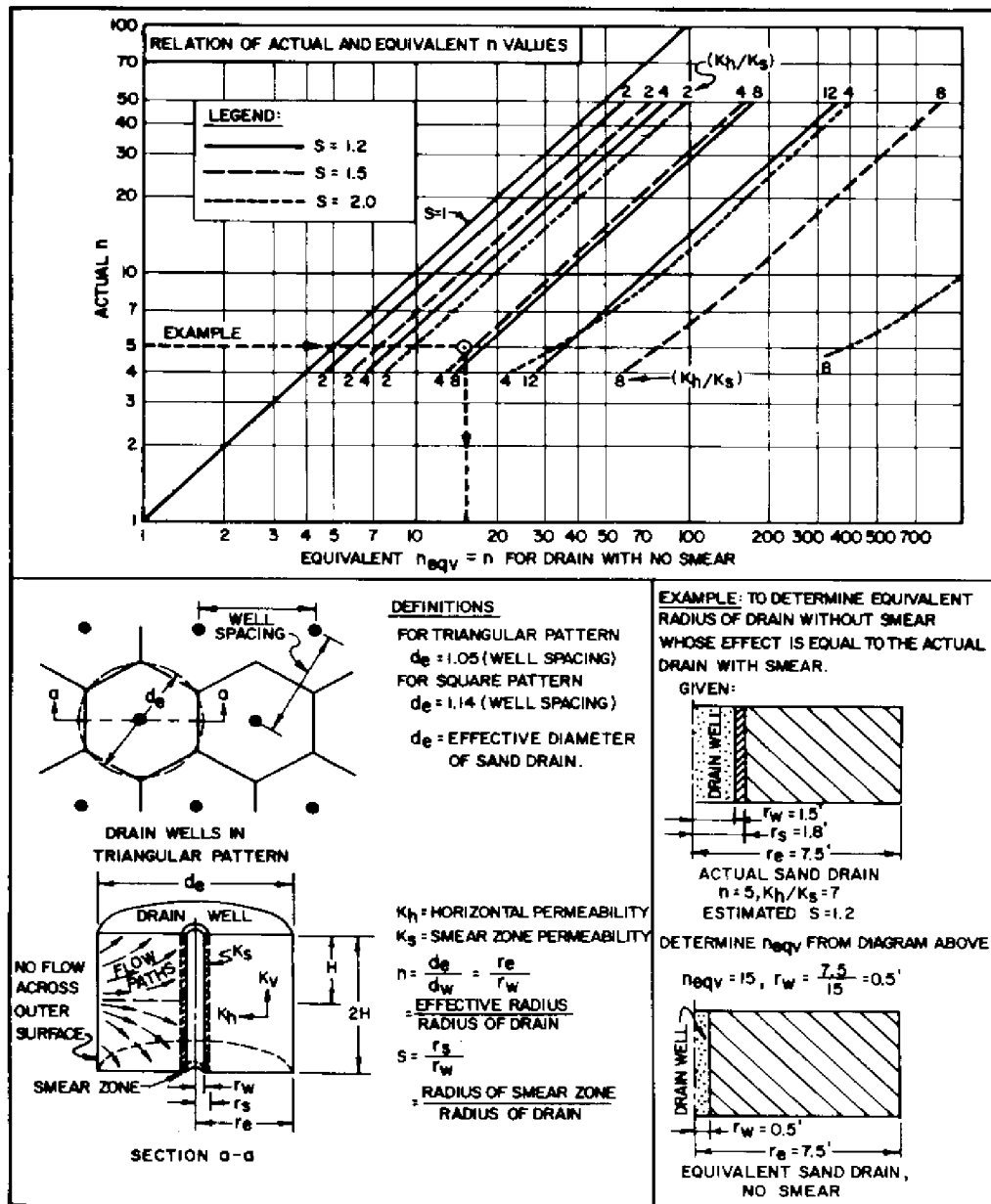

FIGURE 21 Allowance for Smear Effect in Sand Drain Design

e. Sand Drains Plus Surcharge. A surcharge load is normally placed above the final fill level to accelerate the required settlement. Surcharge is especially necessary when the compressible foundation contains material in which secondary compression predominates over primary consolidation. The percent consolidation under the surcharge fill necessary to eliminate a specific amount of settlement under final load is determined as shown in the lowest panel of Figure 20.

f. General Design Requirements. Analyze stability against foundation failure by the methods of Chapter 7, including the effect of pore pressures on the failure plane. Determine allowable buildup of pore pressure in the compressible stratum as height of fill is increased.

(1) Horizontal Drainage. For major installation investigate in detail the horizontal coefficient of consolidation by laboratory tests with drainage in the horizontal direction, or field permeability tests to determine horizontal permeability.

(2) Consolidation Tests. Evaluate the importance of smear or disturbance by consolidation tests on remolded samples. For sensitive soils and highly stratified soils, consider nondisplacement methods for forming drain holes.

(3) Drainage Material. Determine drainage material and arrangement to handle maximum flow of water squeezed from the compressible stratum in accordance with Chapter 6.

g. Construction Control Requirements. Control the rate of fill rise by installing piezometer and observing pore pressure increase for comparison with pore pressure values compatible with stability. Check anticipated rate of consolidation by pore pressure dissipation and settlement measurements.

#### Section 7. ANALYSIS OF VOLUME EXPANSION

1. CAUSES OF VOLUME EXPANSION. Volume expansion is caused by (a) reduction of effective stresses, (b) mineral changes, and (c) formation and growth of ice lenses. Swell with decrease of effective stress is a reverse of the consolidation process. For description of swelling problems and suggested treatment, see Table 8. Where highly preconsolidated plastic clays are present at the ground surface, seasonal cycles of rainfall and desiccation produce volume changes. The most severe swelling occurs with montmorillonite clays although, in an appropriate climate, any surface clay of medium to high plasticity with relatively low moisture content can heave. For estimation of swell potential see Chapter 1, Section 6.

2. MAGNITUDE OF VOLUME EXPANSION. Figure 22 outlines a procedure for estimating the magnitude of swelling that may occur when footings are built on expansive clay soils. This figure also indicates a method of determining the necessary undercut to reduce the heave to an acceptable value. Further guidance for foundations on expansive soils is contained in DM-7.3, Chapter 3.

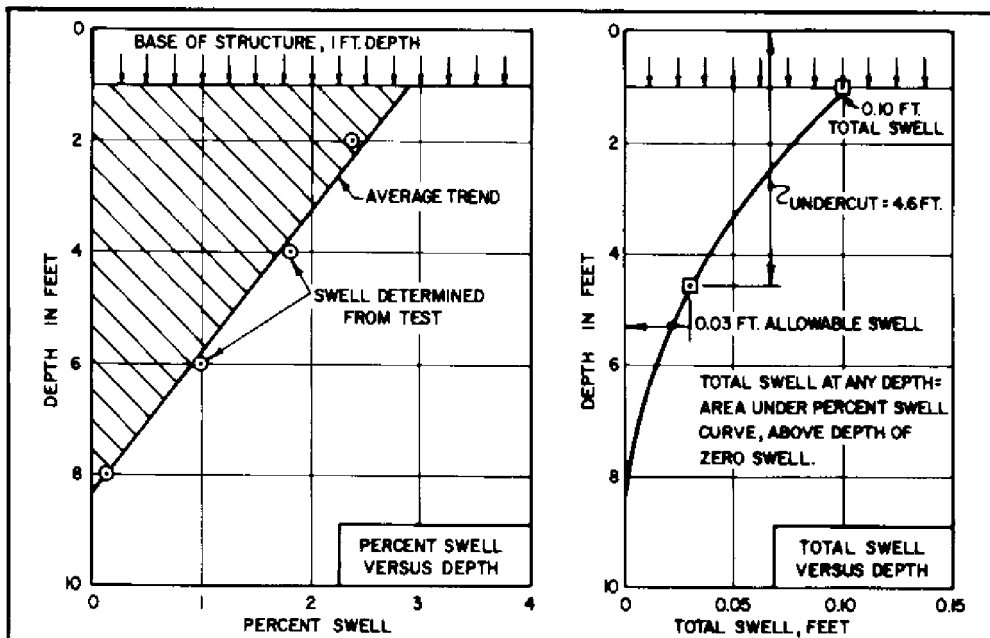

TABLE 8  
Heave From Volume Change

Conditions and materials	Mechanism of heave	Treatment
<p>Reduction of effective stress of overburden: Temporary reduction of effective stress by excavation for structure foundation in preconsolidated clays.</p> <p>Permanent reduction of effective stress by excavation in chemically inert, uncemented clay-shale or shale.</p>	<p>Soil swells in accordance with laboratory e-p curves. Heave is maximum at center of excavation. Total potential heave may not have occurred by time the load is reapplied. Final structural load will recompress foundation materials.</p> <p>In sound shale where water cannot obtain access to the shale, swelling may be insignificant.</p> <p>For hydraulic structures or construction below the ground water table, reduction of effective stresses will cause permanent heave in accordance with laboratory e-p curves. Alternate wetting and drying during excavation increases swelling potential.</p>	<p>Provide drainage for rapid collection of surface water. Avoid disturbance to subgrade by placing 4-in.-thick working mat of lean concrete immediately after exposing subgrade. Leave is minimized if the groundwater is drawn down 3 or 4 ft below base of excavation at its center to maintain capillary stresses.</p> <p>Protect shale from wetting and drying during excavation by limiting area opened at subgrade and with concrete working mat. Pour concrete floors and foundations directly on protected shale with no underfloor drainage course. Backfill around walls with impervious soils to prevent access of water. Provide proper surface drainage and paving if necessary to avoid infiltration.</p> <p>Where an increase in water content is probable, special structural designs must be considered. These include (1) anchoring or rock bolting the floor to a depth in shale that provides suitable hold down against swelling pressures; (2) a floor supported on heavily loaded column footings with an opening or compressible filler beneath floors; and (3) a mat foundation designed to resist potential swelling pressures. In any case, excavation in the shale should be protected by sealing coats or working mat immediately after exposure at subgrade.</p>
<p>Reduction of effective stress of overburden and release of capillary stress: Construction of earth dams of heavily compacted plastic clays.</p>	<p>Intrusion of seepage from reservoir releases capillary pressures and reduces effective stress of overburden and may produce swelling leading to sloughing of the slopes. Most critical material are CH clays with swelling index exceeding 0.07. Compaction at relatively low water contents, where the water deficiency in the clay mineral lattice is high and the degree of saturation is low, will accentuate swelling.</p> <p>Rise of groundwater, seepage, leakage, or elimination of surface evaporation increases degree of saturation and reduces effective stress, leading to expansion.</p>	<p>Avoid placing highly plastic fill on or near embankment slopes. Compact clays at a relatively high moisture content consistent with strength and compressibility requirements. Avoid overcompaction to an unnecessarily high dry unit weight.</p>
<p>Construction of structural fill for light buildings of compacted plastic clay.</p>		<p>Compact clays as wet as practicable consistent with compressibility requirements. Avoid overcompaction of general fill and undercompaction of backfill at column footings or in utility trenches which would accentuate differential movements. Stabilization of compacted fills with various salt admixtures reduces swelling potential by increasing ion concentration in pore water.</p>

TABLE 8 (continued)  
Heave From Volume Change

Conditions and materials	Mechanism of heave	Treatment
<p>Changes of capillary stresses: Construction of light buildings on surface strata of highly preconsolidated clays in temperate climates subject to substantial seasonal fluctuations in rainfall. (Southern England, as an example.)</p>	<p>Seasonal movements 1 or 2 in. upwards and downwards occur within the upper 3 to 5 ft. Settlement occurs in early summer and expansion in the fall. Caused by change of capillary stresses produced by transpiration to nearby trees, plant, or grass cover surrounding the structure. Movements are maximum at edge of building. Groundwater is shallow. Change of capillary stresses by evaporation is not of prime importance.</p>	<p>Light reinforcing or stiffening minimize effects in small houses. Basements carried to usual depths usually eliminate movements.</p>
<p>Construction of light buildings on clays of high activity, highly preconsolidated with fractures and slickensides, in climate where hot summers alternate with wet winters. (South-central Texas for example.)</p>	<p>Even in the absence of vegetal cover, seasonal cycles of settlement and heave occur because of the alternate increase and release of capillary stresses. Buildings constructed during wet season may undergo small but nonuniform settlement beneath exterior footings. Buildings constructed in the dry season undergo uneven heave up to 3 or 4 in. maximum, distributed irregularly over the structure.</p>	<p>Support light footings and slabs on compacted, coarse-grained fill about 4 to 6 ft thick. Pave peripheral areas to minimize subsoil moisture content change. Consider the use of belled caissons with supported floor. Open block wall foundations have been utilized for small houses. Collect rainwater falling on structure and surrounding areas and convey runoff away from structures.</p>
<p>Construction of light to medium load structures in hot, arid climate where the free surface evaporation is several times larger than annual rainfall. Difficulties are greatest in fractured and slickensided clay of high activity, with low water table and maximum deficiency of evaporation over rainfall. (South Africa, as an example.)</p>	<p>Permanent moisture deficiency exists in the ground. Construction eliminates evaporation over building area, reducing capillary stresses and causing movement of moisture to beneath building. This leads to continuing heave with minor seasonal fluctuations. Thermosmotic gradients directed toward cooled subsoil beneath structure contribute to increase in moisture, which may extend to depths of 10 to 15 ft.</p>	<p>Damage is minimized by use of slab or raft foundation, dry wall construction, steel or reinforced concrete framing, reinforced foundation beams, and provision for jacking. Heave is eliminated by removal of desiccated material to a depth of 8 to 12 ft. and replacement by granular fill; or belled caissons, founded near the water table and reinforced to resist tensile forces, supporting floor between caissons with opening or compressible filler beneath floors. Divert rainwater and surface runoff away from structure.</p>
<p>Chemical changes: Excavation and exposure of clay-shales or shales containing pyrite (iron sulphide) or anhydrite (calcium sulphate).</p>	<p>Exposure to air and water causes oxidation and hydration of pyrites with a volumetric expansion of as much as ten times their original volume, or hydration of anhydrite to gypsum.</p>	<p>Rough excavate no closer than one-half foot to final subgrade and protect exposed shale with a spray or mop coat of bitumen. When ready for foundations, excavate to final grade and pour concrete immediately over a spray or mop coat of bitumen.</p>



MATERIALS INVESTIGATED ARE CLAYS, HIGHLY OVERCONSOLIDATED BY CAPILLARY STRESSES THAT ARE EFFECTIVE PRIOR TO THE CONSTRUCTION OF THE STRUCTURE UPON THEM.

PROCEDURE FOR ESTIMATING TOTAL SWELL UNDER STRUCTURE LOAD.

1. OBTAIN REPRESENTATIVE UNDISTURBED SAMPLES OF THE SHALLOW CLAY STRATUM AT A TIME WHEN CAPILLARY STRESSES ARE EFFECTIVE ; I.E. , WHEN NOT FLOODED OR SUBJECTED TO HEAVY RAIN.
2. LOAD SPECIMENS (AT NATURAL WATER CONTENT) IN CONSOLIDOMETER UNDER A PRESSURE EQUAL TO THE ULTIMATE VALUE OF OVERBURDEN FOR HIGH GROUND WATER, PLUS WEIGHT OF STRUCTURE. ADD WATER TO SATURATE AND MEASURE SWELL.
3. COMPUTE FINAL SWELL IN TERMS OF PERCENT OF ORIGINAL SAMPLE HEIGHT AND PLOT SWELL VERSUS DEPTH, AS IN THE LEFT PANEL.
4. COMPUTE TOTAL SWELL WHICH IS EQUAL TO THE AREA UNDER THE PERCENT SWELL VERSUS DEPTH CURVE. FOR THE ABOVE EXAMPLE:  

$$\text{TOTAL SWELL} = 1/2 (8.2 - 1.0) \times 2.8/100 = 0.10 \text{ FT.}$$

PROCEDURE FOR ESTIMATING UNDERCUT NECESSARY TO REDUCE SWELL TO AN ALLOWABLE VALUE.

1. FROM PERCENT SWELL VERSUS DEPTH CURVE PLOT RELATIONSHIP OF TOTAL SWELL VERSUS DEPTH AT THE RIGHT. TOTAL SWELL AT ANY DEPTH EQUALS AREA UNDER THE CURVE AT LEFT, INTEGRATED UPWARD FROM THE DEPTH OF ZERO SWELL.
2. FOR A GIVEN ALLOWABLE VALUE OF SWELL, READ THE AMOUNT OF UNDERCUT NECESSARY FROM THE TOTAL SWELL VERSUS DEPTH CURVE. FOR EXAMPLE, FOR AN ALLOWABLE SWELL OF 0.03 FT, UNDERCUT REQUIRED = 4.6 FT. UNDERCUT CLAY IS REPLACED BY AN EQUAL THICKNESS OF NONSWELLING COMPACTED FILL.

FIGURE 22  
Computation of Swell of Desiccated Clays

## REFERENCES

1. Department of Civil Engineering, University of California, Berkeley, Stresses and Deflections in Foundations and Pavements, Fall, 1965.
2. Duncan, J.M., and Buchignani, A.L., An Engineering Manual For Settlement Studies, University of California, Berkeley, 1976.
3. D'Appolonia, D.J., Poulos, H.G. and Ladd, C.C., Initial Settlement of Structures on Clay, Journal of the Soil Mechanics and Foundation Division, ASCE, Vol. 97, No. SM10, 1971.
4. Schmertmann, J.H., Static Cone to Compute Static Settlement Over Sand, Journal of the Soil Mechanics and Foundation Division, ASCE, Vol. 96, No. SM3, 1976.
5. Oweis, I.S., Equivalent Linear Model For Predicting Settlements of Sand Bases, Journal of the Geotechnical Engineering Division, ASCE, Vol. 105, No. GT12, 1979.
6. Leonards, G.S., Estimating Consolidation Settlements of Shallow Foundation on Overconsolidated Clay, Transportation Research Board Special Report 163, Transportation Research Board, 1976.
7. Departments of the Army and Air Force, Soils and Geology, Procedures for Foundation Design of Buildings and Other Structures, (Except Hydraulic Structures), TM5-818-1/AFM-88-3, Chapter 7, Washington, D.C., 1979.
8. Terzaghi, K. and Peck, R., Soil Mechanics in Engineering Practice, John Wiley & Sons, Inc., New York, 1967.
9. Ladd, C.C., Foott, R., Ishihara, K., Schlosser, F., and Poulos, H.G., Stress Deformation and Strength Characteristics, Proceedings Ninth International Conference on Soil Mechanics and Foundation Engineering, Tokyo, Volume 2, pp 421-494, 1977.
10. Olson, R.E., Consolidation Under Time Dependent Loading, Journal of the Geotechnical Engineering Division, ASCE, Vol. 103, No. GT1, 1977.
11. Institution of Civil Engineers, Structure Soil Interaction, A State of the Art Report, 1978.
12. Bjerrum, L., Allowable Settlements of Structures, Proceedings of European Conference on Soil Mechanics and Foundation Engineering, Wiesbaden, Volume 2, pp 135-137, 1963.
13. Brown, P.T., Numerical Analyses of Uniformly Loaded Circular Rafts on Elastic Layers of Finite Depth, Geotechnique, Vol. 19, No. 2, 1969.
14. Frazer, R.A. and Wardle, L.J., Numerical Analysis of Rectangular Raft on Layered Foundations, Geotechnique, Vol. 26, No. 4, 1976.

15. Ladd, C.C., Use of Precompression and Vertical Sand Drains for Stabilization of Foundation Soils, ASCE New York Metropolitan Section Spuinar, 1978.

CHAPTER 6. SEEPAGE AND DRAINAGE

Section 1. INTRODUCTION

1. SCOPE. This chapter covers surface erosion, and analysis of flow quantity and groundwater pressures associated with underseepage. Requirements are given for methods of drainage and pressure relief.
2. RELATED CRITERIA. Other criteria, relating to groundwater utilization or control, can be found in the following sources:

Subject	Source
Drainage Systems .....	NAVFAC DM-5.03
Drainage for Airfield Pavements .....	NAVFAC DM-21.06
Dewatering and Groundwater Control for Deep Excavations..	NAVFAC P-418

Additional criteria for permanent pressure relief and seepage control beneath structures are given in DM-7.02, Chapter 4.

3. APPLICATIONS. Control of soil erosion must be considered in all new construction projects. Seepage pressures are of primary importance in stability analysis and in foundation design and construction. Frequently, drawdown of groundwater is necessary for construction. In other situations, pressure relief must be incorporated in temporary and permanent structures.
4. INVESTIGATIONS REQUIRED. For erosion analysis, the surface water flow characteristics, soil type, and slope are needed. For analysis of major seepage problems, determine permeability and piezometric levels by field observations. See Chapter 2 for techniques.

Section 2. SEEPAGE ANALYSIS

1. FLOW NET. Figure 1 shows an example of flow net construction. Use this procedure to estimate seepage quantity and distribution of pore water pressures in two-dimensional flow. Flow nets are applicable for the study of cutoff walls and wellpoints, or shallow drainage installations placed in a rectangular layout whose length in plan is several times its width. Flow nets can also be used to evaluate concentration of flow lines.

a. Groundwater Pressures. For steady state flow, water pressures depend on the ratio of mean permeability of separate strata and the anisotropy of layers. A carefully drawn flow net is necessary to determine piezometric levels within the flow field or position of the drawdown curve.

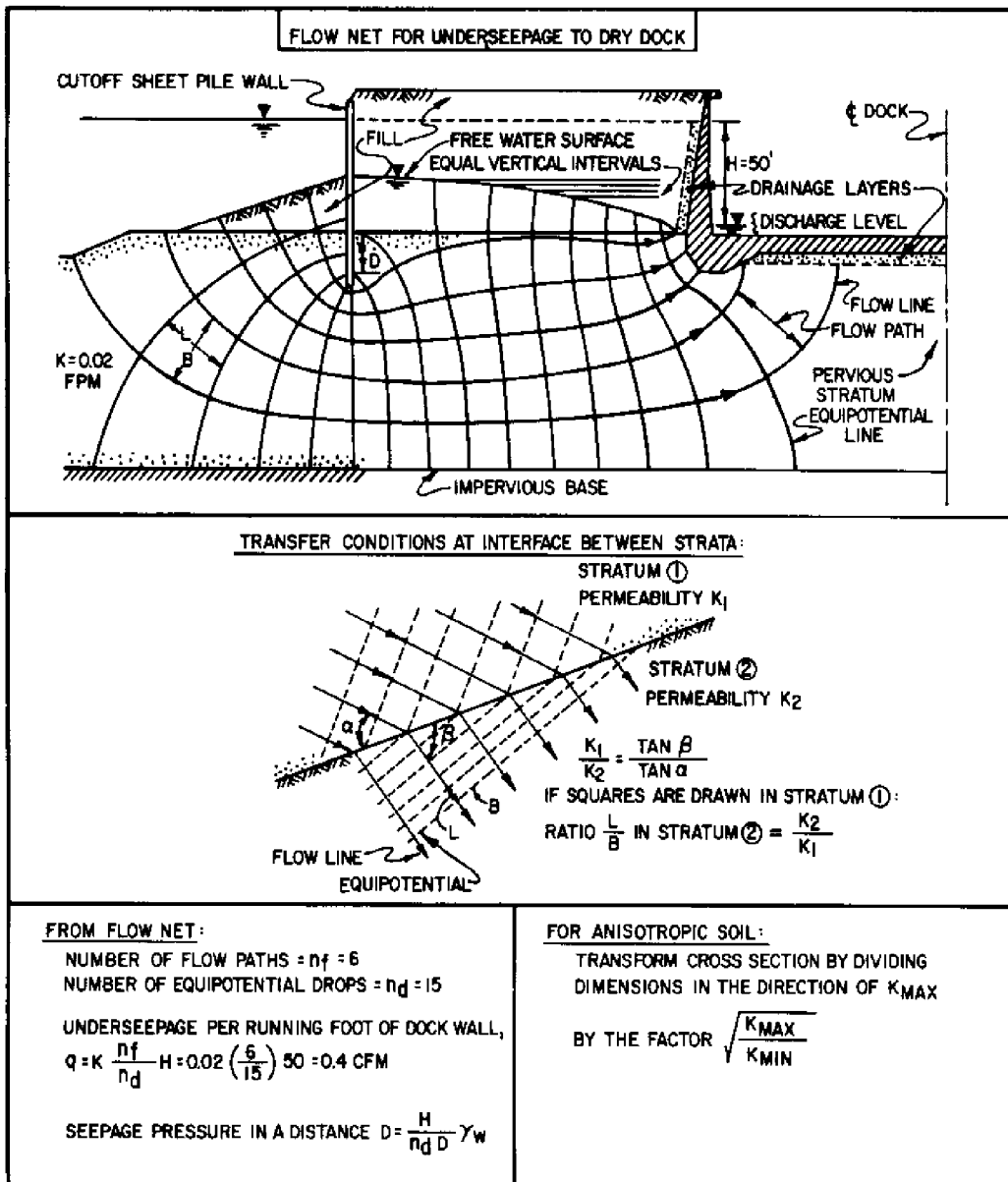

FIGURE 1  
Flow Net Construction and Seepage Analysis

))  
RULES FOR FLOW NET CONSTRUCTION  
))

1. WHEN MATERIALS ARE ISOTROPIC WITH RESPECT TO PERMEABILITY, THE PATTERN OF FLOW LINES AND EQUIPOTENTIALS INTERSECT AT RIGHT ANGLES. DRAW A PATTERN IN WHICH SQUARE FIGURES ARE FORMED BETWEEN FLOW LINES AND EQUIPOTENTIALS
2. USUALLY IT IS EXPEDIENT TO START WITH AN INTEGER NUMBER OF EQUIPOTENTIAL DROPS, DIVIDING TOTAL HEAD BY A WHOLE NUMBER, AND DRAWING FLOW LINES TO CONFORM TO THESE EQUIPOTENTIALS. IN THE GENERAL CASE, THE OUTER FLOW PATH WILL FORM RECTANGULAR RATHER THEN SQUARE FIGURES. THE SHAPE OF THESE RECTANGLES (RATIO B/L) MUST BE CONSTANT.
3. THE UPPER BOUNDARY OF A FLOW NET THAT IS AT ATMOSPHERIC PRESSURE IS A "FREE WATER SURFACE". INTEGER EQUIPOTENTIALS INTERSECT THE FREE WATER SURFACE AT POINTS SPACED AT EQUAL VERTICAL INTERVALS.
4. A DISCHARGE FACE THROUGH WHICH SEEPAGE PASSES IS AN EQUIPOTENTIAL LINE IF THE DISCHARGE IS SUBMERGED, OR A FREE WATER SURFACE IF THE DISCHARGE IS NOT SUBMERGED. IF IT IS A FREE WATER SURFACE, THE FLOW NET FIGURES ADJOINING THE DISCHARGE FACE WILL NOT BE SQUARES.
5. IN A STRATIFIED SOIL PROFILE WHERE RATIO OF PERMEABILITY OF LAYERS EXCEEDS 10, THE FLOW IN THE MORE PERMEABLE LAYER CONTROLS. THAT IS, THE FLOW NET MAY BE DRAWN FOR MORE PERMEABLE LAYER ASSUMING THE LESS PERMEABLE LAYER TO BE IMPERVIOUS. THE HEAD ON THE INTERFACE THUS OBTAINED IS IMPOSED ON THE LESS PERVIOUS LAYER FOR CONSTRUCTION OF THE FLOW NET WITHIN IT.
6. IN A STRATIFIED SOIL PROFILE WHERE RATIO OF PERMEABILITY OF LAYERS IS LESS THAN 10, FLOW IS DEFLECTED AT THE INTERFACE IN ACCORDANCE WITH THE DIAGRAM SHOWN ABOVE.
7. WHEN MATERIALS ARE ANISOTROPIC WITH RESPECT TO PERMEABILITY, THE CROSS SECTION MAY BE TRANSFORMED BY CHANGING SCALE AS SHOWN ABOVE AND FLOW NET DRAWN AS FOR ISOTROPIC MATERIALS. IN COMPUTING QUANTITY OF SEEPAGE, THE DIFFERENTIAL HEAD IS NOT ALTERED FOR THE TRANSFORMATION.

8. WHERE ONLY THE QUANTITY OF SEEPAGE IS TO BE DETERMINED, AN APPROXIMATE FLOW NET SUFFICES. IF PORE PRESSURES ARE TO BE DETERMINED, THE FLOW NET MUST BE ACCURATE.  
))

FIGURE 1 (continued)  
Flow Net Construction and Seepage Analysis



b. Seepage Quantity. Total seepage computed from flow net depends primarily on differential head and mean permeability of the most pervious layer. The ratio of permeabilities of separate strata or their anisotropy has less influence. The ratio  $n_f/n_d$ , in Figure 1 usually ranges from 1/2 to 2/3 and thus for estimating seepage quantity a roughly drawn flow net provides a reasonably accurate estimate of total flow. Uncertainties in the permeability values are much greater limitations on accuracy.

For special cases, the flow regime can be analyzed by the finite element method. Mathematical expressions for the flow are written for each of the elements, considering boundary conditions. The resulting system of equations is solved by computer to obtain the flow pattern (see Appendix A).

2. SEEPAGE FORCES. The flow of water through soil exerts a force on the soil called a seepage force. The seepage pressure is this force per unit volume of soil and is equal to the hydraulic gradient times the unit weight of water.

$$P_s = i [\gamma]_w$$

where

$$P_s = \text{seepage pressure}$$

$$i = \text{hydraulic gradient}$$

$$[\gamma]_w = \text{unit weight of water}$$

The seepage pressure acts in a direction at right angles to the equipotential lines (see Figure 1).

The seepage pressure is of great importance in analysis of the stability of excavations and slopes (see Chapter 7 and DM-7.2, Chapter 1) because it is responsible for the phenomenon known as boiling or piping.

a. Boiling. Boiling occurs when seepage pressures in an upward direction exceed the downward force of the soil. The condition can be expressed in terms of critical hydraulic gradient. A minimum factor of safety of 2 is usually required, i.e.,

$$i_c = i \frac{[\gamma]_T - [\gamma]_W}{[\gamma]_b - [\gamma]_W} = 2$$

where

$$i = \text{actual hydraulic gradient}$$

$$[\gamma]_T = \text{total unit weight of the soil}$$

$$[\gamma]_W = \text{unit weight of water}$$

$$[\gamma]_b = \text{buoyant unit weight of soil}$$

b. Piping and Subsurface Erosion. Most piping failures are caused by subsurface erosion in or beneath dams. These failures can occur several months or even years after a dam is placed into operation.

In essence, water that comes out of the ground at the toe starts a process of erosion (if the exit gradient is high enough) that culminates in the formation of a tunnel-shaped passage (or "pipe") beneath the structure. When the passage finally works backward to meet the free water, a mixture of soil and water rushes through the passage, undermining the structure and flooding the channel below the dam. It has been shown that the danger of a piping failure due to subsurface erosion increases with decreasing grain size.

Similar subsurface erosion problems can occur in relieved drydocks, where water is seeping from a free source to a drainage or filter blanket beneath the floor or behind the walls. If the filter fails or is defective and the hydraulic gradients are critical, serious concentrations of flow can result in large voids and eroded channels.

Potential passageways for the initiation of piping include: uniformly graded gravel deposits, conglomerate, open joints in bedrock, cracks caused by earthquakes or crustal movements, open joints in pipelines, hydraulic fracture, open voids in coarse boulder drains including French drains, abandoned wellpoint holes, gopher holes, cavities formed in levee foundations by rotting roots or buried wood, improper backfilling of pipelines, pipes without antiseepage collars, etc.

Failure by piping requires progressive movement of soil particles to a free exit surface. It can be controlled by adequately designed filters or relief blankets. Guidelines for preventing piping beneath dams may be found in Reference 1, Security from Under Seepage of Masonary Dams on Earth Foundations, by Lee.

3. DEWATERING. Dewatering methods are discussed in Table 7, DM-7.2, Chapter 1. Figures 13 and 14 in DM-7.2, Chapter 1 illustrate some methods of construction dewatering and soil grain size limitations for different dewatering methods. See NAVFAC P-418 for dewatering and groundwater control systems.

4. THREE-DIMENSIONAL FLOW. For analysis of flow quantity and drawdown to individual wells or to any array of wells, see Section 5.

### Section 3. SEEPAGE CONTROL BY CUTOFF

1. METHODS. Procedures for seepage control include cutoff walls for decreasing the seepage quantity and reducing the exit gradients, and drainage or relief structures that increase flow quantity but reduce seepage pressures or cause drawdown in critical areas. See Table 1; Table 7 of DM-7.2, Chapter 1; and DM-7.3, Chapter 3 (Diaphragm Walls) for methods of creating partial or complete cutoff. See NAVFAC P-418 for construction dewatering.

2. SHEETPILING. A driven line of interlocking steel sheeting may be utilized for a cutoff as a construction expedient or as a part of the completed structure.

a. Applicability. The following considerations govern the use of sheetpiling:

TABLE I  
Cutoff Methods for Seepage Control

Method	Applicability	Characteristics and Requirements
Sheet pile cut off wall	Suited especially for stratified soils with high horizontal and low vertical permeability or pervious hydraulic fill materials. May be easily damaged by boulders or buried obstructions. Tongue and groove wood sheeting utilized for shallow excavation in soft to medium soils. Interlocking steel sheetpiling is utilized for deeper cutoff.	Steel sheeting must be carefully driven to maintain interlocks tight. Steel H-pile soldier beams may be used to minimize deviation of sheeting in driving. Some deviation of sheeting from plumb toward the side with least horizontal pressure should be expected. Seepage through interlocks is minimized where tensile force acts across interlocks. For straight wall sheeting an appreciable flow may pass through interlocks. Decrease interlock leakage by filling interlocks with sawdust, bentonite, cement grout, or similar material.
Compacted barrier of impervious soil	Formed by compacted backfill in a cutoff trench carried down to impervious material or as a core section in earth dams.	Layers or streaks of pervious material in the impervious zone must be avoided by careful selection and mixing of borrow materials, scarifying lifts, aided by sheepsfoot rolling. A drainage zone downstream of an impervious section of the embankment is necessary in most instances.

TABLE 1 (continued)  
Cutoff Methods for Seepage Control

Method	Applicability	Characteristics and Requirements
Grouted or injected cutoff	Applicable where depth or character of foundation materials make sheetpile wall or cutoff trench impractical. Utilized extensively in major hydraulic structures. May be used as a supplement below cutoff sheeting or trenches.	A complete positive grouted cutoff is often difficult and costly to attain, requiring a pattern of holes staggered in rows with carefully planned injection sequence and pressure control. See DM-7.3, Chapter 2 for materials and methods.
Slurry trench method	Suited for construction of impervious cutoff trench below groundwater or for stabilizing trench excavation. Applicable whenever cutoff walls in earth are required. Is replacing sheetpile cutoff walls.	Vertical sided trench is excavated below groundwater as slurry with specific gravity generally between 1.2 and 1.8 is pumped back into the trench. Slurry may be formed by mixture of powdered bentonite with fine-grained material removed from the excavation. For a permanent cutoff trench, such as a foundation wall or other diaphragm wall, concrete is tremied to bottom of trench, displacing slurry upward. Alternatively, well graded backfill material is dropped through the slurry in the trench to form a dense mixture that is essentially an incompressible mixture; in working with coarser gravels (which may settle out), to obtain a more reliable key into rock, and a narrower trench, use a cement-bentonite mix.

TABLE 1 (continued)  
Cutoff Methods for Seepage Control

Method	Applicability	Characteristics and Requirements
<p>Impervious wall of mixed in-place piles.</p>	<p>Method may be suitable to form cofferdam wall where sheet pile cofferdam is expensive or cannot be driven to suitable depths, or has insufficient rigidity, or requires excessive bracing.</p>	<p>For a cofferdam surrounding an excavation, a line of overlapping mixed in-place piles are formed by a hollow shaft auger or mixing head rotated into the soil while cement grout is pumped through the shaft. Where piles cannot be advanced because of obstructions or boulders, supplementary grouting or injection may be necessary.</p>
<p>Freezing - ammonium brine or liquid nitrogen</p>	<p>All types of saturated soils and rock. Forms ice in voids to stop water. Ammonium brine is better for large applications of long duration. Liquid nitrogen is better for small applications of short duration where quick freezing is needed.</p>	<p>Gives temporary mechanical strength to soil. Installation costs are high and refrigeration plant is expensive. Some ground heave occurs.</p>

See also DM-7.2 Chapter 1, Table 10, DM-7.3 Chapter 3 (for diaphragm walls as a cutoff), and DM-7.3 Chapter 2 (for grouted cutoffs and freezing).

(1) Sheet piling is particularly suitable in coarse-grained material with maximum sizes less than about 6 inches or in stratified subsoils with alternating fine grained and pervious layers where horizontal permeability greatly exceeds vertical.

(2) To be effective, sheet piling must be carefully driven with interlocks intact. Boulders or buried obstructions are almost certain to damage sheet piling and break interlock connections. Watertightness cannot be assumed if obstructions are present.

(3) Loss of head across a straight wall of intact sheet piling depends on its watertightness relative to the permeability of the surrounding soil. In homogeneous fine-grained soil, head loss created by sheet piling may be insignificant. In pervious sand and gravel, head loss may be substantial depending on the extent to which the flow path is lengthened by sheet piling. In this case, the quantity of water passing through intact interlocks may be as much as 0.1 gpm per foot of wall length for each 10 feet differential in head across sheet piling, unless special measures are taken to seal interlocks.

b. Penetration Required. This paragraph and Paragraph "c" below apply equally to all impervious walls listed in Table 1. Seepage beneath sheet piling driven for partial cutoff may produce piping in dense sands or heave in loose sands. Heave occurs if the uplift force at the sheet piling toe exceeds the submerged weight of the overlying soil column. To prevent piping or heave of an excavation carried below groundwater, sheet piling must penetrate a sufficient depth below subgrade or supplementary drainage will be required at subgrade. See Figure 2 (Reference 2, Model Experiments to Study the Influence of Seepage on the Stability of a Sheeted Excavation in Sand, by Marsland) for sheet piling penetration required for various safety factors against heave or piping in isotropic sands. For homogeneous but anisotropic sands, reduce the horizontal cross-section dimensions by the transformation factor of Figure 1 to obtain the equivalent cross section for isotropic conditions. See Figure 3 (Reference 2) for sheet piling penetration required in layered subsoils. For clean sand, exit gradients between 0.5 and 0.75 will cause unstable conditions for men and equipment operating on the subgrade. To avoid this, provide sheet piling penetration for a safety factor of 1.5 to 2 against piping or heave.

c. Supplementary Measures. If it is uneconomical or impractical to provide required sheet piling penetration, the seepage exit gradients may be reduced as follows:

(1) For homogeneous materials or soils whose permeability decreases with depth, place wellpoints, pumping wells, or sumps within the excavation. Wellpoints and pumping wells outside the excavation are as effective in some cases and do not interfere with bracing or excavation.

(2) For materials whose permeability increases with depth, ordinary relief wells with collector pipes at subgrade may suffice.

(3) A pervious berm placed against the sheet piling, or a filter blanket at subgrade, will provide weight to balance uplift pressures. Material placed directly on the subgrade should meet filter criteria of Section 4.

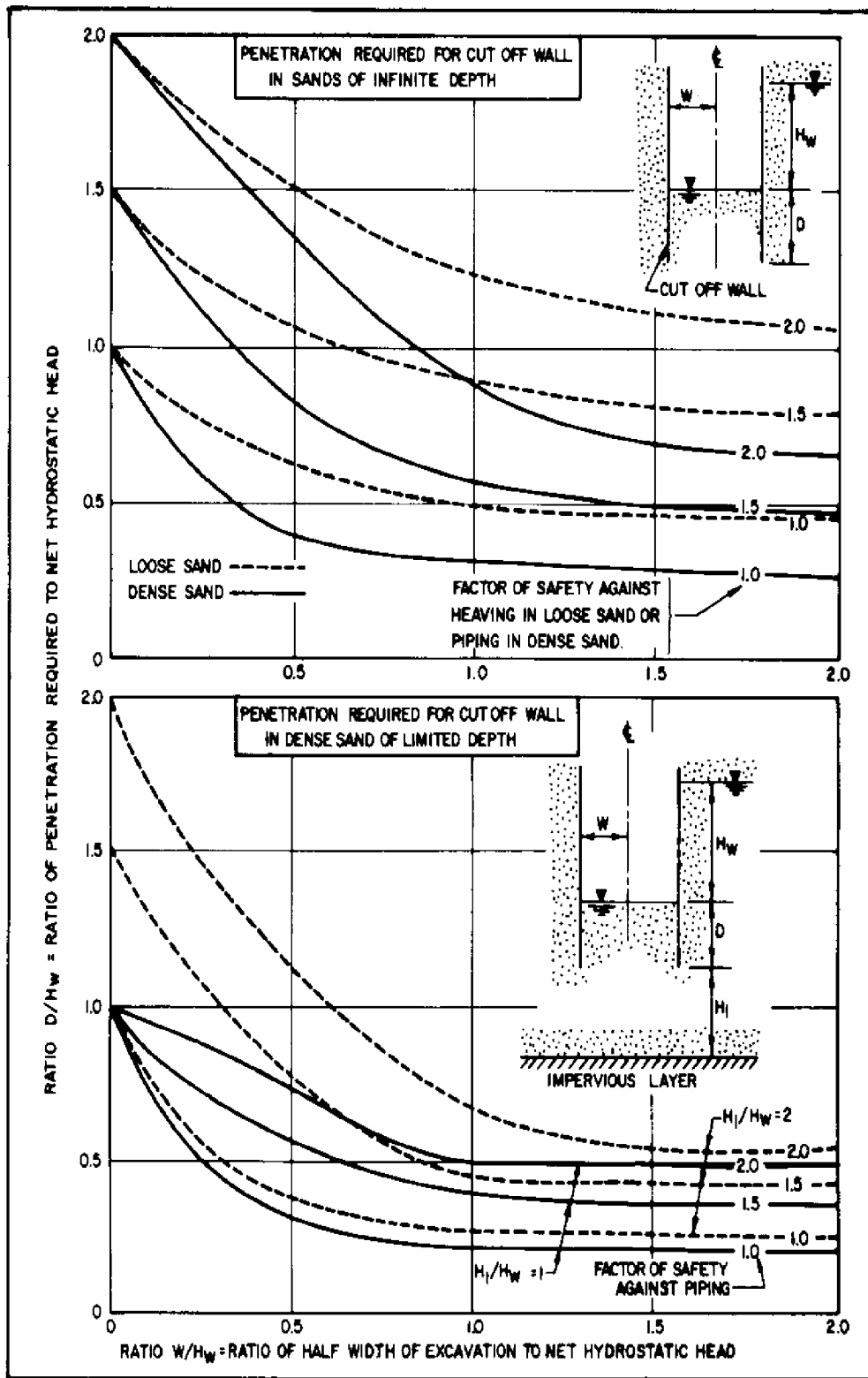

FIGURE 2  
Penetration of Cut Off Wall to Prevent Piping in Isotropic Sand

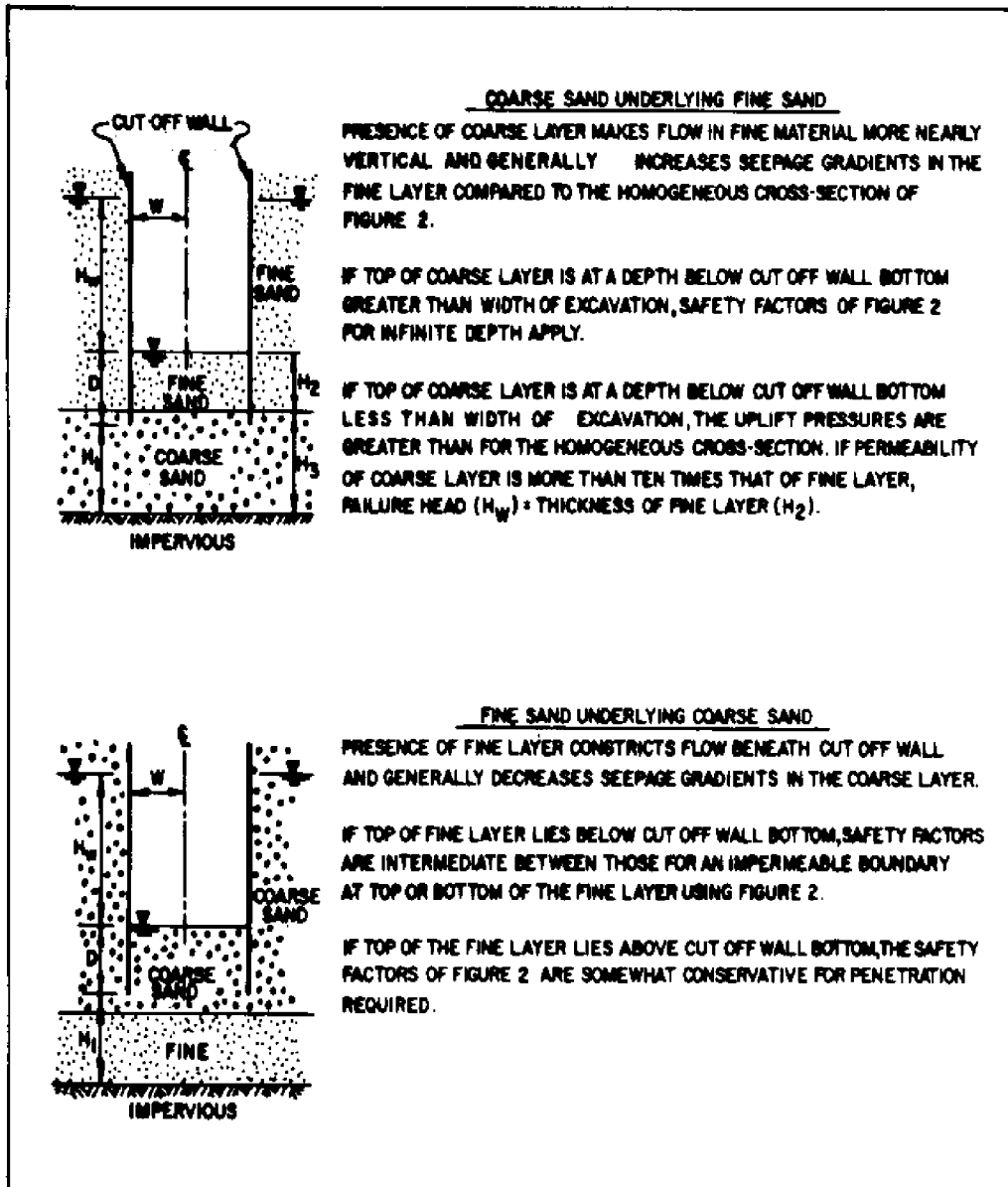
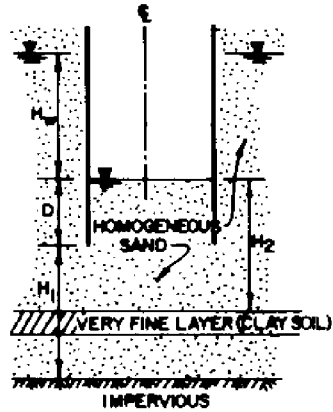

FIGURE 3  
Penetration of Cut Off Wall Required to Prevent Piping in Stratified Sand



FINE LAYER IN HOMOGENEOUS SAND STRATUM



IF THE TOP OF FINE LAYER IS AT A DEPTH GREATER THAN WIDTH OF EXCAVATION BELOW CUT OFF WALL BOTTOM, SAFETY FACTORS OF FIGURE 2 APPLY, ASSUMING IMPERVIOUS BASE AT TOP OF FINE LAYER.

IF TOP OF FINE LAYER IS AT A DEPTH LESS THAN WIDTH OF EXCAVATION BELOW CUT OFF WALL TIPS, PRESSURE RELIEF IS REQUIRED SO THAT UNBALANCED HEAD BELOW FINE LAYER DOES NOT EXCEED HEIGHT OF SOIL ABOVE BASE OF LAYER.

IF FINE LAYER LIES ABOVE SUBGRADE OF EXCAVATION, FINAL CONDITION IS SAFER THAN HOMOGENEOUS CASE, BUT DANGEROUS CONDITION MAY ARISE DURING EXCAVATION ABOVE THE FINE LAYER AND PRESSURE RELIEF IS REQUIRED AS IN THE PRECEDING CASE.

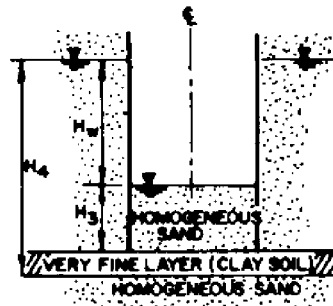

TO AVOID BOTTOM HEAVE,  $\gamma_T \times H_3$  SHOULD BE GREATER THAN  $\gamma_W \times H_4$ .

$\gamma_T$  = TOTAL UNIT WEIGHT OF THE SOIL

$\gamma_W$  = UNIT WEIGHT OF WATER

FIGURE 3 (continued)  
Penetration of Cut Off Wall Required to Prevent Piping in Stratified Sand

(4) An outside open water source may be blanketed with fines or bentonite dumped through water or placed as a slurry. See Table 2.

Evaluate the effectiveness of these measures by flow net analysis.

3. GROUTED CUTOFF. For grouting methods and materials, see DM-7.3, Chapter 2. Complete grouted cutoff is frequently difficult and costly to attain. Success of grouting requires careful evaluation of pervious strata for selection of appropriate grout mix and procedures. These techniques, in combination with other cutoff or drainage methods, are particularly useful as a construction expedient to control local seepage.

4. IMPERVIOUS SOIL BARRIERS. Backfilling of cutoff trenches with selected impervious material and placing impervious fills for embankment cores are routine procedures for earth dams.

a. Compacted Impervious Fill. Properly constructed, these sections permit negligible seepage compared to the flow through foundations or abutments. Pervious layers or lenses in the compacted cutoff must be avoided by blending of borrow materials and scarifying to bond successive lifts.

b. Mixed-in-Place Piles. Overlapping mixed-in-place piles of cement and natural soil forms a cofferdam with some shear resistance around an excavation.

c. Slurry-filled Trench. Concurrent excavation of a straight sided trench and backfilling with a slurry of bentonite with natural soil is done. Alternatively, a cement bentonite mix can be used in a narrower trench where coarser gravel occurs. In certain cases, tremie concrete may be placed, working upward from the base of a slurry-filled trench, to form a permanent peripheral wall (Diaphragm Wall, see DM-7.3, Chapter 3).

5. FREEZING. See Section 2, DM-7.3, Chapter 2, and Table 7, DM-7.2, Chapter 1.

#### Section 4. DESIGN OF DRAINAGE BLANKET AND FILTERS

1. FILTERS. If water flows from a silt to a gravel, the silt will wash into the interstices of the gravel. This could lead to the following, which must be avoided:

(1) The loss of silt may continue, causing creation of a cavity.

(2) The silt may clog the gravel, stopping flow, and causing hydrostatic pressure buildup.

The purpose of filters is to allow water to pass freely across the interface (filter must be coarse enough to avoid head loss) but still be sufficiently fine to prevent the migration of fines. The filter particles must be durable, e.g., certain crushed limestones may dissolve. Filter requirements apply to all permanent subdrainage structures in contact with soil, including wells. See Figure 4 for protective filter design criteria.

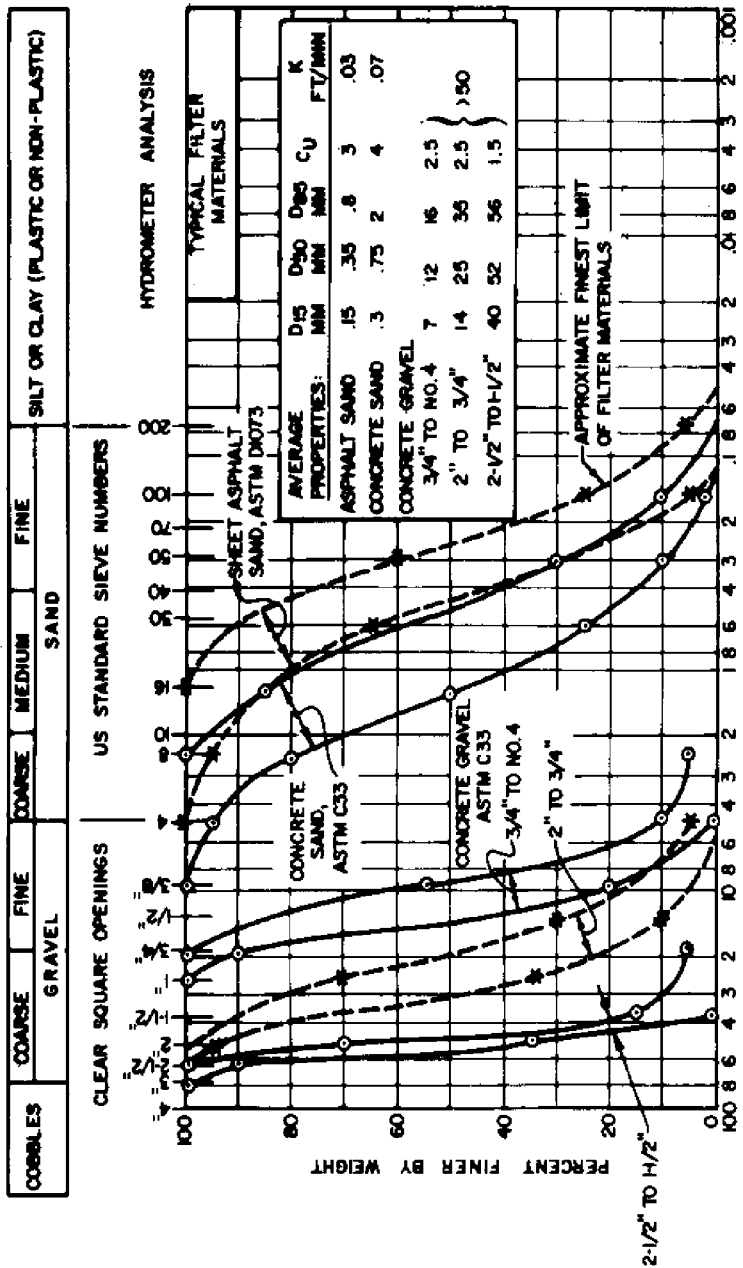

FIGURE 4  
Design Criteria for Protective Filters

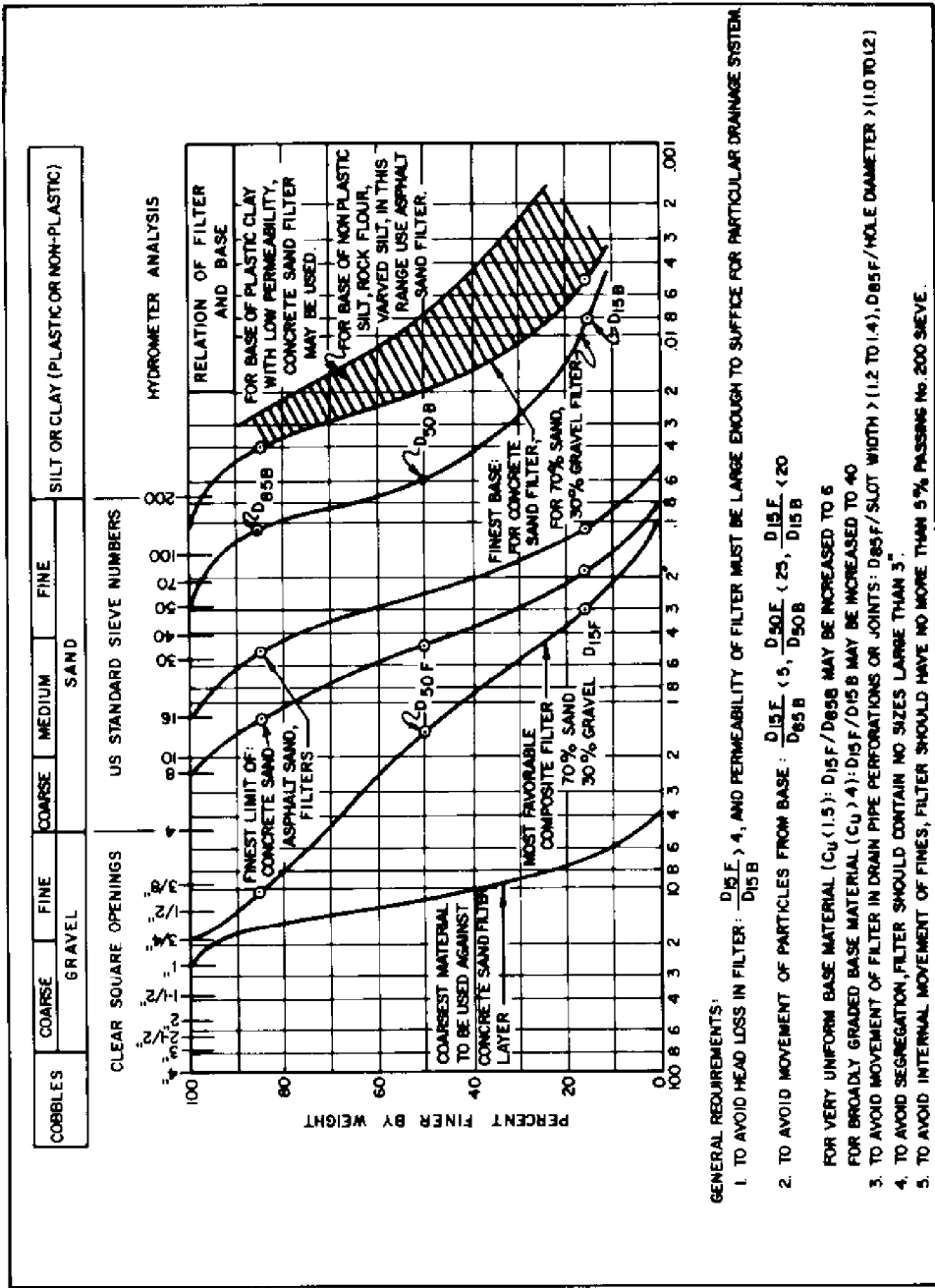

FIGURE 4 (continued)  
Design Criteria for Protective Filters

The filter may be too fine grained to convey enough water, to provide a good working surface, or to pass the water freely without loss of fines to a subdrain pipe. For this condition, a second filter layer is placed on the first filter layer; the first filter layer is then considered the soil to be protected, and the second filter layer is designed. The finest filter soil is often at the base, with coarser layers above. This is referred to as reversed or inverted filters.

Concrete sand (ASTM C33, Specifications for Concrete Aggregates) suffices as a filter against the majority of fine-grained soils or silty or clayey sands. For non-plastic silt, varved silt, or clay with sand or silt lenses, use asphalt sand (ASTM D1073, Specifications for Fine Aggregates for Bituminous Paving Mixtures) but always check the criteria in Figure 4. Locally available natural materials are usually more economical than processed materials, and should be used where they meet filter criteria. The fine filter layer can be replaced with plastic filter cloths under the following conditions (after Reference 3, Performance of Plastic Filter Cloths as a Replacement for Granular Materials, by Calhoun, et al.):

(a) Non-woven filter cloths, or woven filter cloths with less than 4% open area should not be used where silt is present in sandy soils. A cloth with an equivalent opening size (EOS) equal to the No. 30 sieve and an open area of 36% will retain sands containing silt.

(b) When stones are to be dropped directly on the cloth, or where uplift pressure from artesian water may be encountered, the minimum tensile strengths (ASTM D1682, Tests for Breaking Load and Elongation of Textile Fabrics) in the strongest and weakest directions should be not less than 350 and 200 lbs. respectively. Elongation at failure should not exceed 35%. The minimum burst strength should be 520 psi (ASTM D751, Testing Coated Fabrics). Where the cloths are used in applications not requiring high strength or abrasion resistance, the strength requirements may be relaxed.

(c) Cloths made of polypropylene, polyvinyl chloride and polyethylene fibers do not deteriorate under most conditions, but they are affected by sunlight, and should be protected from the sun. Materials should be durable against ground pollutants and insect attack, and penetration by burrowing animals.

(d) Where filter cloths are used to wrap collection pipes or in similar applications, backfill should consist of clean sands or gravels graded such that the D+85, is greater than the EOS of the cloth. When trenches are lined with filter cloth, the collection pipe should be separated from the cloth by at least six inches of granular material.

(e) Cloths should be made of monofilament yarns, and the absorption of the cloth should not exceed 1% to reduce possibility of fibers swelling and changing EOS and percent of open area.

For further guidance on types and properties of filter fabrics see Reference 4, Construction and Geotechnical Engineering Using Synthetic Fabrics, by Koerner and Welsh.

2. DRAINAGE BLANKET. Figure 5 shows typical filter and drainage blanket installations.

a. Permeability. Figure 6 (Reference 5, Subsurface Drainage of Highways, by Barber) gives typical coefficients of permeability for clean, coarse-grained drainage material and the effect of various percentages of fines on permeability. Mixtures of about equal parts gravel with medium to coarse sand have a permeability of approximately 1 fpm. Single sized, clean gravel has a permeability exceeding 50 fpm. For approximate relationship of permeability versus effective grain size  $D_{10}$ , see Figure 1, Chapter 3.

b. Drainage Capacity. Estimate the quantity of water which can be transmitted by a drainage blanket as follows:

$$q = k \text{ [multiplied by] } i \text{ [multiplied by] } A$$

where

$q$  = quantity of flow, ft.<sup>3</sup>/sec

$k$  = permeability coefficient, ft/sec

$i$  = average gradient in flow direction, ft/ft

$A$  = cross sectional area of blanket, ft.<sup>2</sup>

The gradient is limited by uplift pressures that may be tolerated at the point farthest from the outlet of the drainage blanket. Increase gradients and flow capacity of the blanket by providing closer spacing of drain pipes within the blanket.

(1) Pressure Relief. See bottom panel of Figure 7 (Reference 6, Seepage Requirements of Filters and Pervious Bases, by Cedergren) for combinations of drain pipe spacing, drainage course thickness, and permeability required for control of flow upward from an underlying aquifer under an average vertical gradient of 0.4.

(2) Rate of Drainage. See the top panel of Figure 7 (Reference 5) for time rate of drainage of water from a saturated base course beneath a pavement. Effective porosity is the volume of drainable water in a unit volume of soil. It ranges from 25 percent for a uniform material such as medium to coarse sand, to 15 percent for a broadly graded sand-gravel mixture.

c. Drainage Blanket Design. The following guidelines should be followed:

(1) Gradation. Design in accordance with Figure 4.

(2) Thickness. Beneath, structures require a minimum of 12 inches for each layer with a minimum thickness of 24 inches overall. If placed on wet, yielding, uneven excavation surface and subject to construction operation and traffic, minimum thickness shall be 36 inches overall.

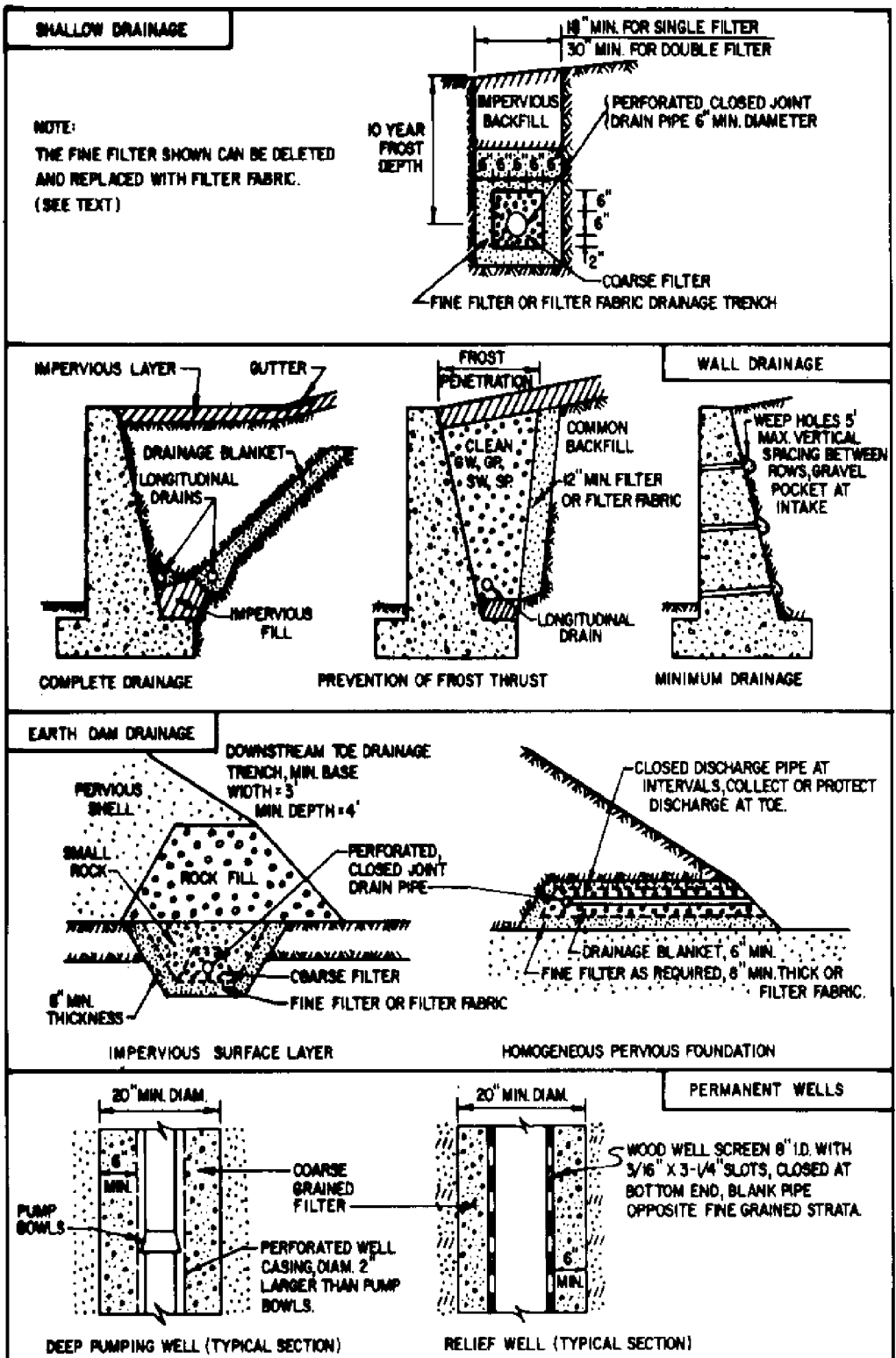

FIGURE 5  
Typical Filter and Drainage Blanket Applications

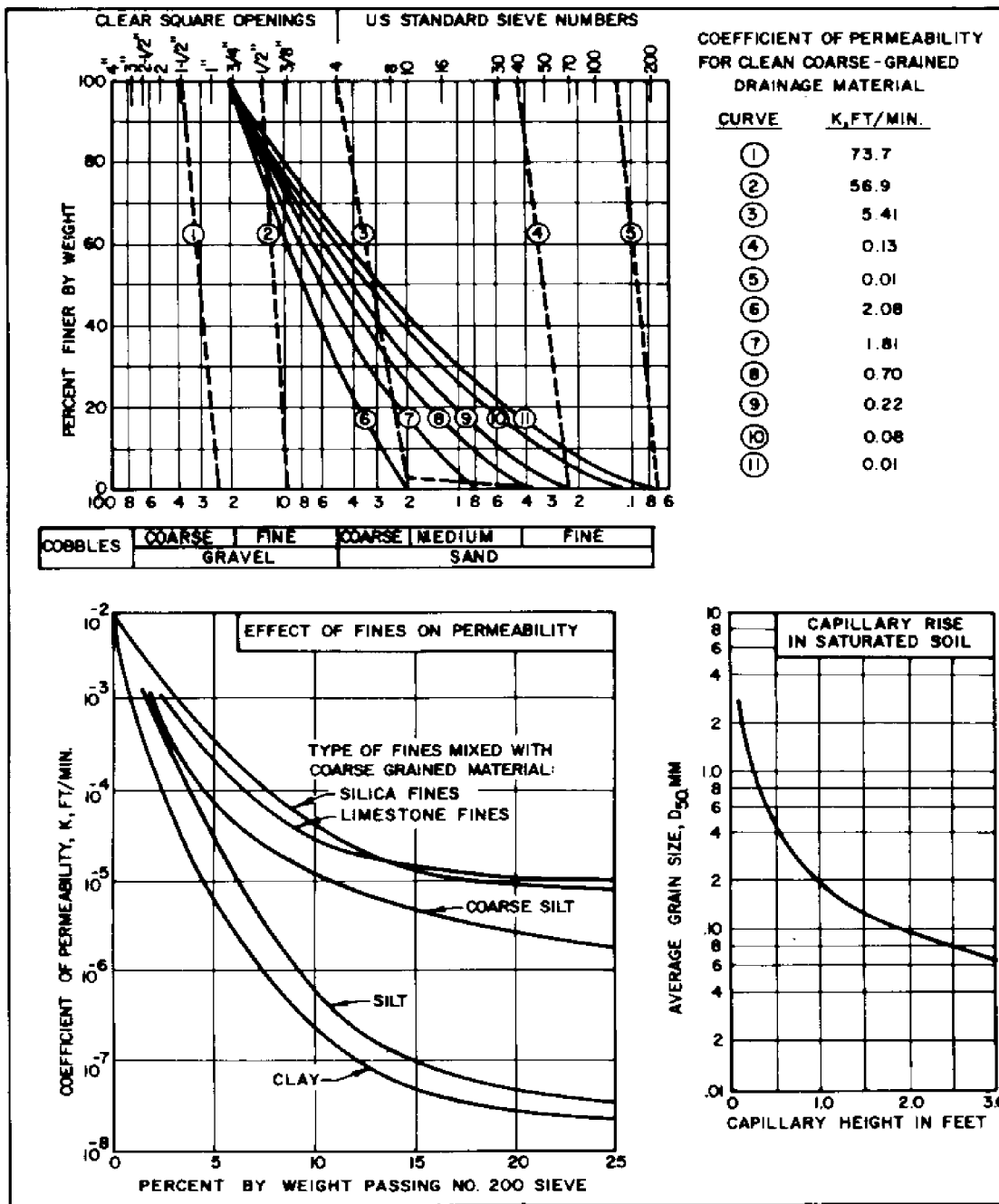
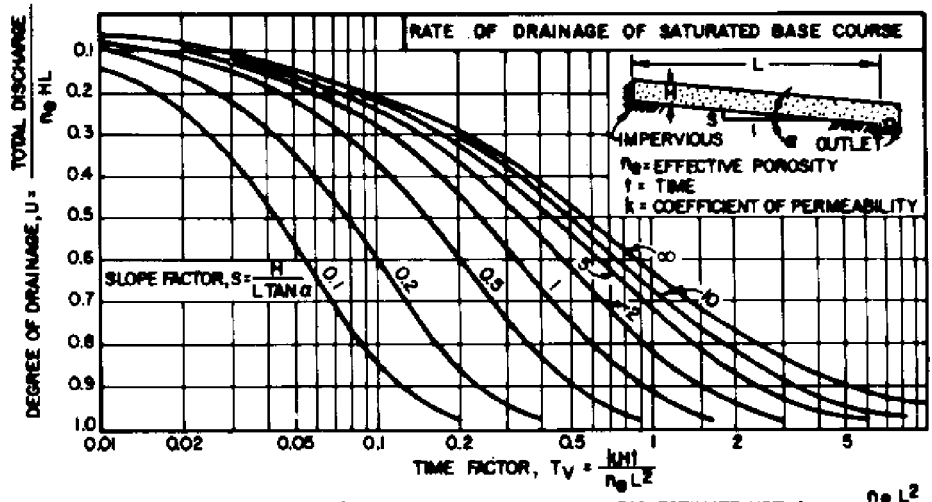

FIGURE 6  
Permeability and Capillarity of Drainage Materials





SELECT DRAIN SPACING, L SO THAT 50% DRAINAGE WILL BE COMPLETED IN 10 DAYS.

$$t_{50} = \frac{T_v \rho_g L^2}{k H}$$

FOR ESTIMATE USE:  $t_{50} = \frac{\rho_g L^2}{2k(H+L \tan \alpha)}$

$$t_{50} \text{ DRAINAGE RATE: } q = k H \frac{(H+L \tan \alpha)}{2L}$$

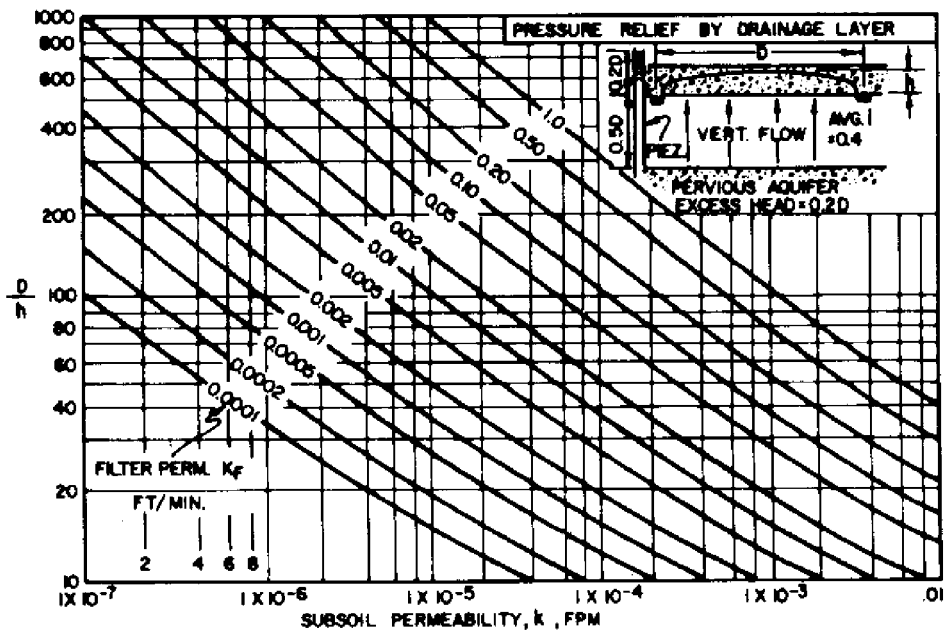

ASSUMPTIONS:  
STEADY SEEPAGE MOVES VERTICALLY UPWARD FROM AQUIFER AT DEPTH 0.5D WITH AVERAGE GRADIENT = 0.4.

TO PREVENT BREAKOUT OF SEEPAGE ON GROUND SURFACE, SELECT FILTER PERMEABILITY AND THICKNESS SO THAT MAX. HEIGHT OF WATER IN DRAINAGE LAYER (h) IS LESS THAN FILTER THICKNESS.

FIGURE 7  
Analysis of Drainage Layer Performance

d. Chemical Clogging. Filter systems (filter layers, fabrics, pipes) can become chemically clogged by ferruginous (iron) and carbonate depositions and incrustations. Where the permanent subdrainage system is accessible, pipes with larger perforations (3/8 inch) and increased thickness of filter layers can be used. For existing facilities, a weak solution of hydrochloric acid can be used to dissolve carbonates.

3. INTERCEPTING DRAINS. Intercepting drains consist of shallow trenches with collector pipes surrounded by drainage material, placed to intercept seepage moving horizontally in an upper pervious stratum. To design proper control drains, determine the drawdown and flow to drains by flow net analysis. Figure 8 shows typical placements of intercepting drains for roadways on a slope.

4. SHALLOW DRAINS FOR PONDED AREAS. Drains consisting of shallow stone trenches with collector pipes can be used to collect and control surface runoff. See Figure 9 (Reference 7, Seepage Into Ditches From a Plane Water Table Overlying a Gravel Substratum, by Kirkham; and Reference 8, Seepage Into Ditches in the Case of a Plane Water Table And an Impervious Substratum, by Kirkham) for determination of rate of seepage into drainage trenches. If sufficient capacity cannot be provided in trenches, add surface drainage facilities.

5. PIPES FOR DRAINAGE BLANKETS AND FILTERS. Normally, perforated wall pipes of metal or plastic or porous wall concrete pipes are used as collector pipes. Circular perforations should generally not be larger than 3/8 inch. Filter material must be graded according to the above guidelines.

Pipes should be checked for strength. Certain deep buried pipes may need a cradle. Check for corrosiveness of soil and water; certain metal pipes may not be appropriate.

Since soil migration may occur, even in the best designed systems, install cleanout points so that the entire system can be flushed and snaked.

#### Section 5. WELLPOINT SYSTEMS AND DEEP WELLS

1. METHODS. Excavation below groundwater in soils having a permeability greater than 10. -3- fpm generally requires dewatering to permit construction in the dry. For materials with a permeability between 10. -3- and 10. -5- fpm, the amount of seepage may be small but piezometric levels may need to be lowered in order to stabilize slopes or to prevent softening of subgrades. Drawdown for intermediate depths is normally accomplished by wellpoint systems or sumps.

Deep drainage methods include deep pumping wells, relief wells, and deep sheeted sumps. These are appropriate when excavation exceeds a depth that can be dewatered efficiently by wellpoint systems alone or when the principal source of seepage is from lower permeable strata.

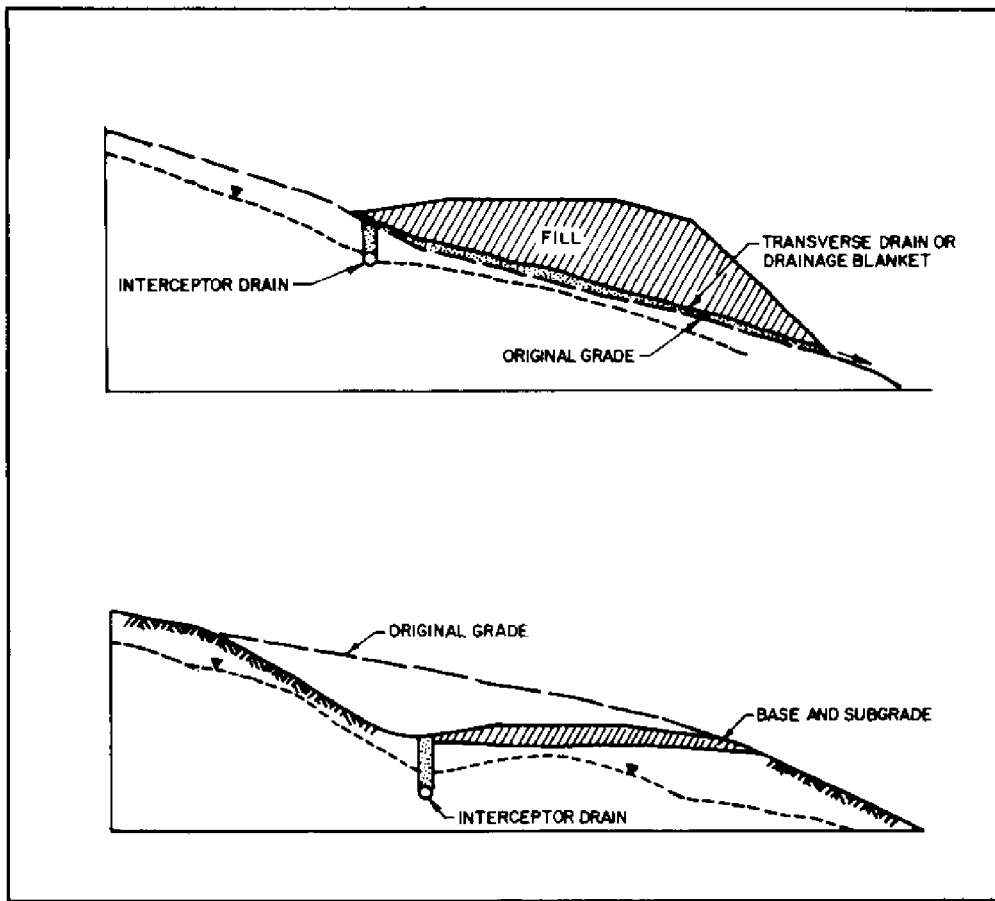

FIGURE 8  
Intercepting Drains for Roadways on a Slope

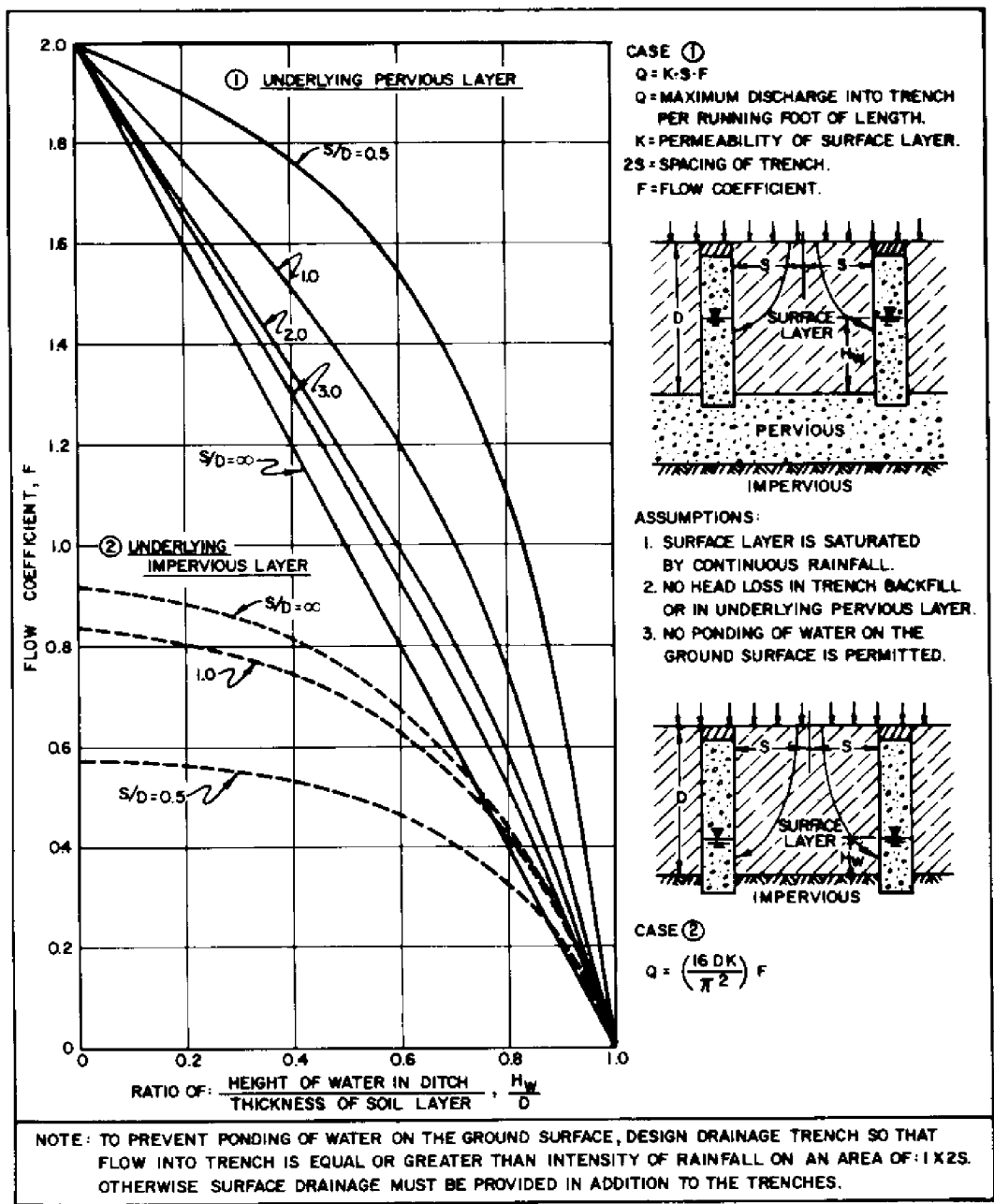

FIGURE 9  
 Rate of Seepage into Drainage Trench

a. Construction Controls. For important construction dewatering, install piezometers below the base of excavations and behind slopes or cofferdams to check on the performance and adequacy of drainage system.

b. Settlement Effects. Where dewatering lowers the water levels in permeable strata adjacent to compressible soils, settlement may result. See Chapter 5 for methods of settlement evaluation.

c. Dewatering Schemes. For construction of dewatering systems and procedures, refer to DM-7.2, Chapter 1, and NAVFAC P-418.

2. WELLPOINT SYSTEMS. Wellpoints consist of 1-1/2 or 2-inch diameter pipes with a perforated bottom section protected by screens. They are jetted or placed in a prepared hole and connected by a header pipe to suction pumps.

a. Applicability. Wellpoints depend upon the water flowing by gravity to the well screen. Pumping methods for gravity drainage generally are not effective when the average effective grain size of a soil  $D_{+10}$ , is less than 0.05 mm. In varved or laminated soils where silty fine sands are separated by clayey silts or clay, gravity drainage may be effective even if the average material has as much as 50 percent smaller than 0.05 mm. Compressible, fine-grained materials containing an effective grain size less than 0.01 mm can be drained by providing a vacuum seal at the ground surface around the wellpoint, utilizing atmospheric pressure as a consolidating force. See Section 4 for limitations due to iron and carbonate clogging.

b. Capacity. Wellpoints ordinarily produce a drawdown between 15 and 18 feet below the center of the header. For greater drawdown, install wellpoints in successive tiers or stages as excavation proceeds. Discharge capacity is generally 15 to 30 gpm per point. Points are spaced between 3 and 10 feet apart. In finely stratified or varved materials, use minimum spacing of points and increase their effectiveness by placing sand in the annular space surrounding the wellpoint.

c. Analysis. Wellpoint spacing usually is so close that the seepage pattern is essentially two dimensional. Analyze total flow and drawdown by flow net procedure. (See Section 2.) For fine sands and coarser material, the quantity of water to be removed controls wellpoint layout. For silty soils, the quantity pumped is relatively small and the number and spacing of wellpoints will be influenced by the time available to accomplish the necessary drawdown.

3. SUMPS. For construction convenience or to handle a large flow in pervious soils, sumps can be excavated with soldier beam and horizontal wood lagging. Collected seepage is removed with centrifugal pumps placed within the sump. Analyze drawdown and flow quantities by approximating the sump with an equivalent circular well of large diameter.

Sheeted sumps are infrequently used. Unsheeted sumps are far more common, and are used primarily in dewatering open shallow excavations in coarse sands, clean gravels, and rock.

4. ELECTRO-OSMOSIS. This is a specialized procedure utilized in silts and clays that are too fine-grained to be effectively drained by gravity or vacuum methods. See DM-7.03, Chapter 2.

5. PUMPING WELLS. These wells are formed by drilling a hole of sufficient diameter to accommodate a pipe column and filter, installing a well casing, and placing filter material in the annular space surrounding the casing. Pumps may be either the turbine type with a motor at the surface and pipe column with pump bowls hung inside the well, or a submersible pump placed within the well casing.

a. Applications. Deep pumping wells are used if (a) dewatering installations must be kept outside the excavation area, (b) large quantities are to be pumped for the full construction period, and (c) pumping must commence before excavation to obtain the necessary time for drawdown. See Figure 10 (bottom panel, Reference 9, Analysis of Groundwater Lowering Adjacent to Open Water, by Avery) for analysis of drawdown and pumping quantities for single wells or a group of wells in a circular pattern. Deep wells may be used for gravels to silty fine sands, and water bearing rocks. See Section 4 for limitations due to iron and carbonate clogging.

Bored shallow wells with suction pumps can be used to replace wellpoints where pumping is required for several months or in silty soils where correct filtering is critical.

b. Special Methods. Ejector or eductor pumps may be utilized within wellpoints for lifts up to about 60 feet. The ejector pump has a nozzle arrangement at the bottom of two small diameter riser pipes which remove water by the Venturi principle. They are used in lieu of a multistage wellpoint system and if the large pumping capacity of deep wells is not required. Their primary application is for sands, but with proper control they can also be used in silty sands and sandy silts.

6. RELIEF WELLS. These wells are sand columns used to bleed water from underlying strata containing artesian pressures, and to reduce uplift forces at critical location. Relief wells may be tapped below ground by a collector system to reduce back pressures acting in the well.

a. Applications. Relief wells are frequently used as construction expedients, and in situations where a horizontal drainage course may be inadequate for pressure relief of deep foundations underlain by varved or stratified soils or soils whose permeability increases with depth.

b. Analysis. See Figure 11 (Reference 10, Soil Mechanics Design, Seepage Control, by the Corps of Engineers) for analysis of drawdown produced by line of relief wells inboard of a long dike. To reduce uplift pressures  $h+m$ , midway between the wells to safe values, vary the well diameter, spacing, and penetration to obtain the best combination.

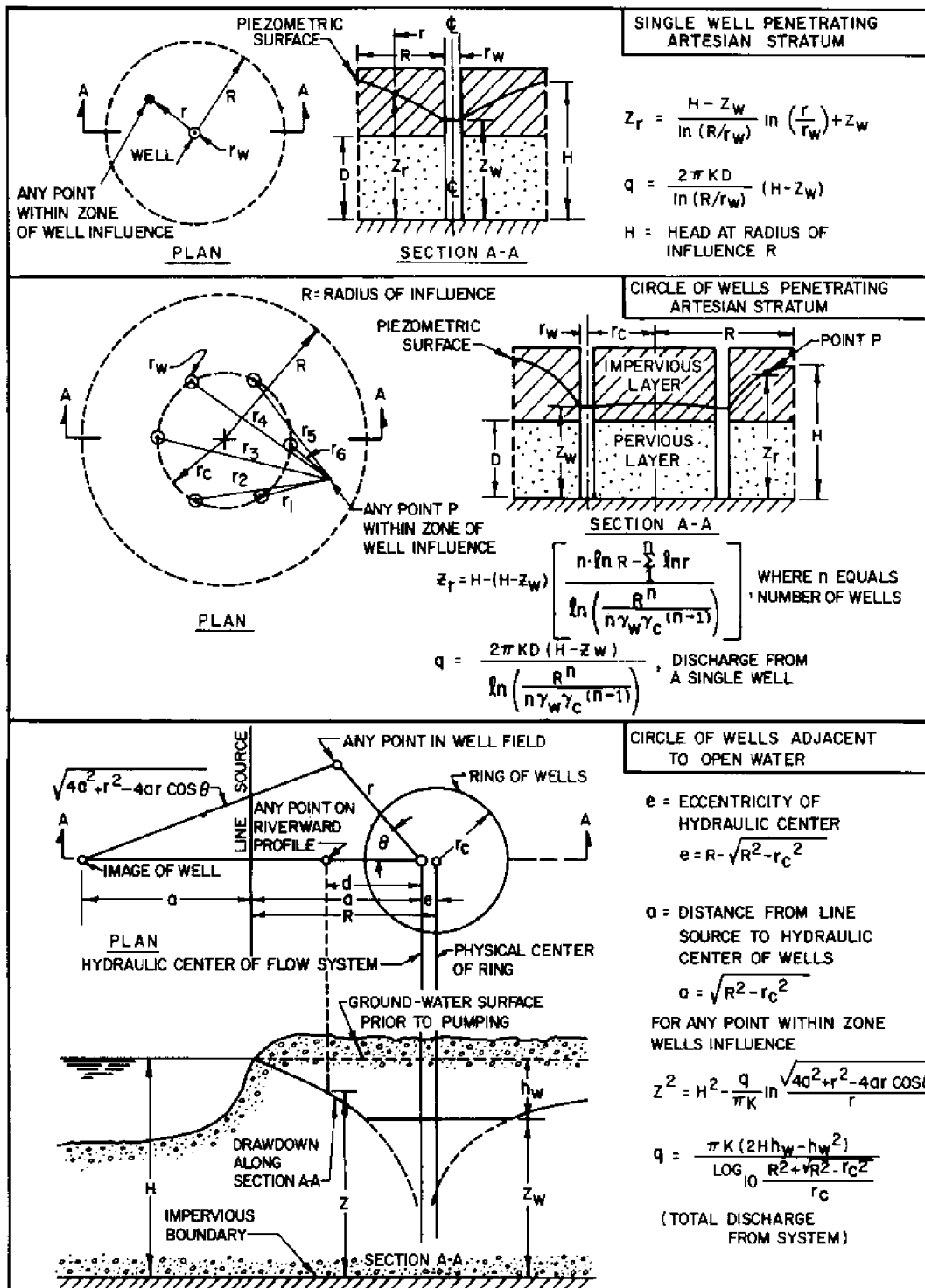

FIGURE 10  
Groundwater Lowering by Pumping Wells

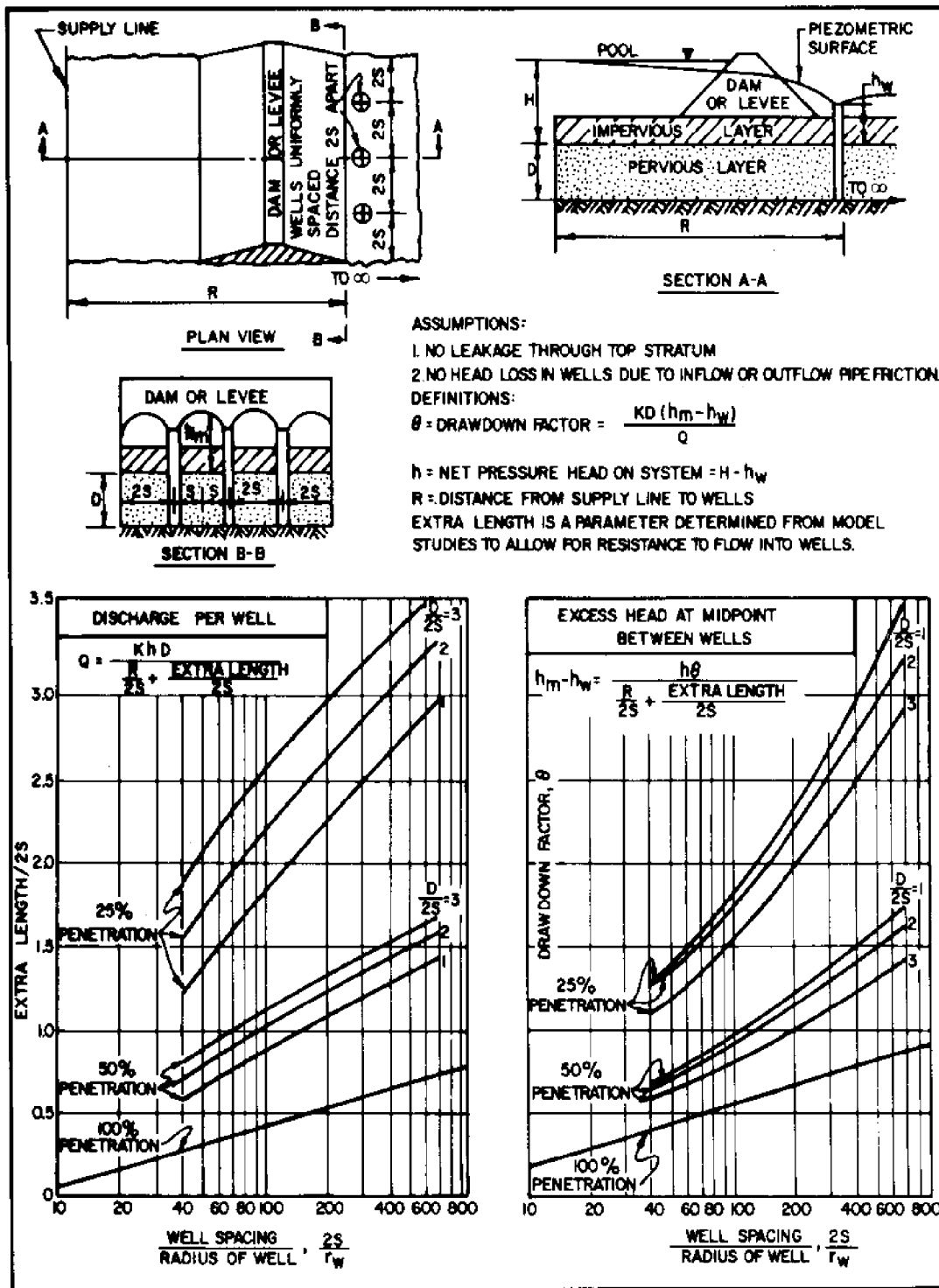

FIGURE 11  
Drainage of Artesian Layer by Line of Relief Wells



## Section 6. LININGS FOR RESERVOIRS AND POLLUTION CONTROL FACILITIES

1. PURPOSE. Linings are used to reduce water loss, to minimize seepage which can cause instability in embankments, and to keep pollutants from migrating to groundwater sources as in holding ponds at sewage treatment and chemical facilities, and in sanitary landfills. For further guidance see Reference 4 and Reference 11, Wastewater Stabilization Pond Linings, by the Cold Regions Research and Engineering Laboratory.
2. TYPES. Table 2 lists types of linings appropriate where wave forces are insignificant. Where erosive forces are present, combine lining with slope protection procedure. See Chapter 7, Section 6.
3. SUBDRAINAGE. If the water level in the reservoir may fall below the surrounding groundwater level, a permanent subdrainage system should be provided below the lining.
4. INVESTIGATION FOR LINING. Check any potential lining for reaction to pollutants (e.g., synthetic rubber is subject to attack by hydrocarbons), potential for insect attack (e.g., certain synthetic fabrics may be subject to termite attack), and the potential for borrowing animals breaching the lining.

## Section 7. EROSION CONTROL

1. GENERAL. The design of erosion controls must consider the volume of runoff from precipitation, the runoff velocity, and the amount of soil loss.
  - a. Volume of Runoff. The volume of runoff depends on the amount of precipitation, ground cover, and topography. For guidance on evaluating the volume of runoff see DM-5.3 or Reference 12, Urban Hydrology for Small Watersheds, by the Soil Conservation Service.
  - b. Amount of Soil Loss. Soil losses can be estimated using the Universal Soil Loss Equation developed by the Soil Conservation Service:

$$A = EI \text{ [multiplied by] } KLS$$

- where
- A = computed soil loss per acre, in tons
  - EI = rainfall erosion index
  - K = soil erodibility factor
  - L = slope length factor
  - S = slope gradient factor

TABLE 2

Impermeable Reservoir Linings

+))))))))))0))))))))))1	Method	Applicability and Procedures	)
/))))))))))3))))))))))1	* Buried Plastic Liner	* Impervious liner formed of black colored polyvinyl chloride plastic film. Where foundation is rough or rocky, place a layer 2 to 4 inches thick of fine-grained soil beneath liner. Seal liner sections by bonding with manufacturer's recommended solvent with 6-inch overlap at joints. Protect liner by 6-inch min. cover of fine grained soil. On slopes add a 6-inch layer of gravel and cobbles 3/4 to 3-inch size. Anchor liner in a trench at top of slope. Avoid direct contact with sunlight during construction before covering with fill and in completed installation. Usual thickness range of 20 to 45 mils (.020" to .045"). Items to be specified include Tensile Strength (ASTM D412), Elongation at Break (ASTM D412), Water Absorption (ASTM D471), Cold Bend (ASTM D2136), Brittleness Temperature (ASTM D746), Ozone Resistance (ASTM D1149), Heat Aging Tensile Strength and Elongation at Break (ASTM D412), Strength - Tear and Grab (ASTM D751).	*
/))))))))))3))))))))))1	* Buried Synthetic Rubber Liner	* Impervious liner formed by synthetic rubber, most often polyester reinforced. Preparation, sealing, protection, anchoring, sunlight, thickness, and ASTM standards are same as Buried Plastic Liner.	*
/))))))))))3))))))))))1	* Bentonite Seal	* Bentonite placed under water to seal leaks after reservoir filling. For placing under water, bentonite may be poured as a powder or mixed as a slurry and placed into the reservoir utilizing methods recommended by the manufacturer. Use at least 0.8 pounds of bentonite for each square foot of area, with greater concentration at location of suspected leaks. For sealing silty or sandy soils, bentonite should have no more than 10 percent larger than 0.05 mm; for gravelly and rocky materials, bentonite can have as much as 40 percent larger than 0.05 mm. For sealing channels with flowing water or large leaks, use mixture of 1/3 each of sodium bentonite, calcium bentonite, and sawdust.	*
.))))))))))2))))))))))-			-

TABLE 2 (continued)  
Impermeable Reservoir Linings

Method	Applicability and Procedures
* Earth Lining	* Lining generally 2 to 4 feet thick of soils having low permeability. Used on bottom and sides of reservoir extending to slightly above operating water levels. Permeability of soil should be no greater than about 2x10 <sup>-6</sup> fpm for water supply linings and 2x10 <sup>-7</sup> fpm for pollution control facility linings.
* Thin Compacted Soil Lining with Chemical Dispersant	* Dispersant is utilized to minimize thickness of earth lining required by decreasing permeability of the lining. Used where wave action is not liable to erode the lining. Dispersant, such as sodium tetrphosphate, is spread on a 6-inch lift of clayey silt or clayey sand. Typical rate of application is 0.05 lbs/sf. Chemical and soil are mixed with a mechanical mixer and compacted by sheepsfoot roller. Using a suitable dispersant, the thickness of compacted linings may be limited to about 1 foot; the permeability of the compacted soil can be reduced to 1/10 of its original value.

EI, L, and S values should be obtained from local offices of the U.S. Soil Conservation Service. K values may be determined from published data on a particular locality. In the absence of such data, it may be roughly estimated from Figure 12 (after Reference 13, Erosion Control on Highway Construction, by the Highway Research Board).

2. INVESTIGATION. Where erosion can be expected during earthwork construction, on-site investigations should include: (1) field identification and classification for both agricultural textures and the Unified system, (2) sampling for grain size distribution, Atterberg limits and laboratory classification, and (3) determination of in-place densities (see Chapter 2).

3. SURFACE EROSION CONTROL. For typical erosion control practices see Table 3, (modified from Reference 13). General considerations to reduce erosion include:

a. Construction Scheduling. Schedule construction to avoid seasons of heavy rains. Winds are also seasonal, but are negligible in impact compared to water erosion.

b. Soil Type. Avoid or minimize exposure of highly erodible soils. Sands easily erode but are easy to trap. Clays are more erosion resistant, but once eroded, are more difficult to trap.

c. Slope Length and Steepness. Reduce slope lengths and steepness to reduce velocities. Provide benches on slopes at maximum vertical intervals of 30 feet.

d. Cover. Cover quickly with vegetation, such as grass, shrubs and trees, or other covers such as mulches. A straw mulch applied at 2 tons/acre may reduce soil losses as much as 98% on gentle slopes. Other mulches include asphalt emulsion, paper products, jute, cloth, straw, wood chips, sawdust, netting of various natural and man-made fibers, and, in some cases, gravel.

e. Soil Surface. Ridges perpendicular to flow and loose soil provide greater infiltration.

f. Exposed Area. Minimize the area opened at any one time. Retain as much natural vegetation as possible. Leave vegetation along perimeters to control erosion and act as a sediment trap.

g. Diversion. Minimize flow over disturbed areas, such as by placing a berm at the top of a disturbed slope.

h. Sprinkling. Control dust by sprinkling of exposed areas.

i. Sediment Basins. Construct debris basins to trap debris and silt before it enters streams.

4. CHANNEL LININGS. Table 4 presents guidelines for minimizing erosion of earth channels and grass covered channels (modified after Reference 14, Minimizing Erosion in Urbanizing Areas, by the Soil Conservation Service).

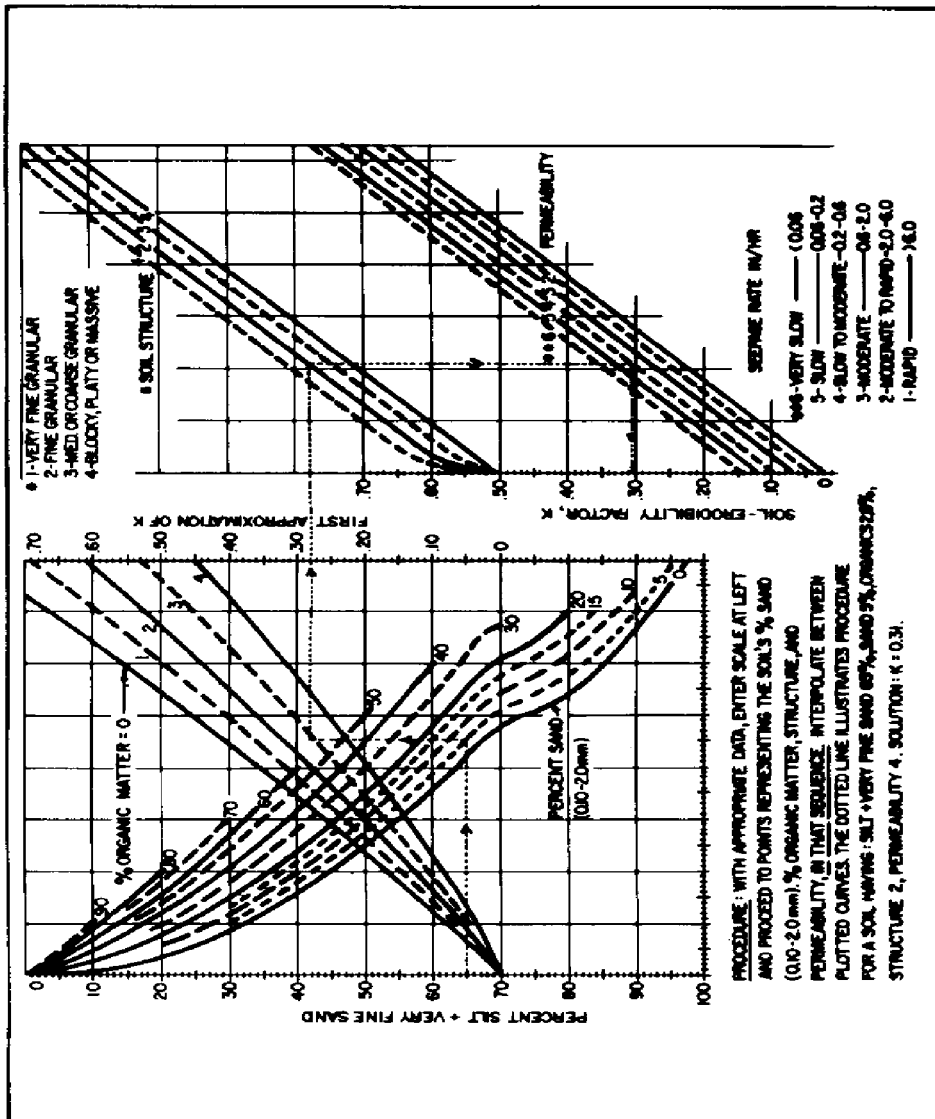

FIGURE 12  
 Nomograph for Determining Soil Erodibility (K) for  
 Universal Soil Loss Equation

TABLE 3  
Typical Erosion Control Practice





Treatment Practice	Advantages	Problems
FILL SLOPES		
<p><b>BERMS AT TOP OF EMBANKMENT</b></p> 	<p>Prevent runoff from embankment surface from flowing over face of fill Collect runoff for slope drains or protected ditch Can be placed as a part of the normal construction operation and incorporated into fill or shoulders</p>	<p>Cooperation of construction operators to place final lifts at edge or shaping into berm Difficult to compact outside lift when work is resumed Sediment buildup and berm and slope failure</p>
<p><b>SLOPE DRAINS</b></p> 	<p>Prevent fill slope erosion caused by embankment surface runoff Can be constructed of full or half section pipe, bituminous, metal, concrete, plastic, or other waterproof material Can be extended as construction progresses May be either temporary or permanent</p>	<p>Permanent construction as needed may not be considered desirable by contractor Removal of temporary drains may disturb growing vegetation Energy dissipation devices are required at the outlets</p>
<p><b>FILL BERMS OR BENCHES</b></p> 	<p>Slows velocity of slope runoff Collects sediments Provides access for maintenance Collects water for slope drains May utilize waste</p>	<p>Requires additional fill material if waste is not available May cause sloughing Additional construction area may be needed</p>
<p><b>SEEDING/MULCHING</b></p> 	<p>Timely application of mulch and seeding decreases the period a slope is subject to severe erosion Mulch that is cut in or otherwise anchored will collect sediment. The furrows made will also hold water and sediment</p>	<p>Seeding season may not be favorable Not 100 percent effective in preventing erosion Watering may be necessary Steep slopes or locations with high velocities may require supplemental treatment.</p>

TABLE 3 (continued)  
Typical Erosion Control Practice



Treatment Practice	Advantages	Problems
PROTECTION OF ADJACENT PROPERTY		
 <p>BRUSH BARRIERS</p>	<p>Use slashing and logs from clearing operation Can be covered and seeded rather than removed Eliminates need for burning or disposal off right-of-way</p>	<p>May be considered unsightly in urban areas</p>
 <p>STRAW BALE BARRIERS</p>	<p>Straw is readily available in many areas When properly installed, they filter sediment and some turbidity from runoff</p>	<p>Requires removal Subject to vandal damage Flow is slow through straw requiring considerable area</p>
 <p>SEDIMENT TRAPS</p>	<p>Collect much of the sediment spill from fill slopes and storm drain ditches Inexpensive Can be cleaned and expanded to meet need</p>	<p>Does not eliminate all sediment and turbidity Space is not always available</p>
 <p>SEDIMENT POOLS</p>	<p>Can be designed to handle large volumes of flow Both sediment and turbidity are removed May be incorporated into permanent erosion control plan</p>	<p>Requires prior planning, additional construction area and/or flow easement If removal is necessary, can present a major effort during final construction stage Clean-out volumes can be large Access for clean-out not always convenient; Anti-seepage baffles required for permanent construction</p>
 <p>FENCE TRAPS</p>	<p>Low cost Temporary measure can be erected with minimum supervision</p>	<p>Some maintenance needed depending on length of time in place</p>

TABLE 3 (continued)  
Typical Erosion Control Practice



Treatment Practice	Advantages	Problems
PROTECTION OF ADJACENT PROPERTY (continued)		
<p>ENERGY DISSIPATORS</p> 	<p>Slow velocity to permit sediment collection and to minimize channel erosion off project</p>	<p>Collects debris and requires cleaning Requires special design and construction of large shot rock or other suitable material from project</p>
<p>LEVEL SPREADERS</p> 	<p>Spreads channel or pipe flow to sheet flow Avoids channel easements and construction off project Simple to construct</p>	<p>Adequate spreader length may not be available Sodding of overflow berm is usually required Must be a part of the permanent erosion control effort Maintenance forces must maintain spreader until no longer required</p>
PROTECTION OF STREAM		
<p>CONSTRUCTION DIKE</p> 	<p>Permits work to continue during normal stream stages Controlled flooding can be accomplished during periods of inactivity</p>	<p>Usually requires pumping of work site water into sediment pond Subject to erosion from stream and from direct rainfall on dike</p>
<p>COFFERDAM</p> 	<p>Work can be continued during most anticipated stream conditions Clear water can be pumped directly back into stream No material deposited in stream</p>	<p>Expensive</p>
<p>TEMPORARY STREAM CHANNEL CHANGE</p>	<p>Prepared channel keeps normal flows away from construction</p>	<p>New channel usually will require protection Stream must be returned to old channel and temporary channel refilled</p>

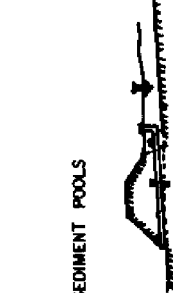
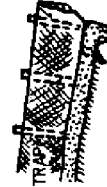

TABLE 3 (continued)  
Typical Erosion Control Practice

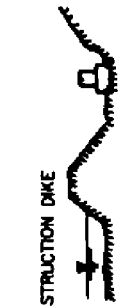
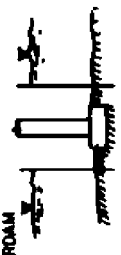

Treatment Practice	Advantages	Problems
PROTECTION OF STREAM (continued)		
<p><b>PIP PIP</b></p> 	<p>Sacked sand with cement or stone easy to stockpile and place Can be installed in increments as needed</p>	<p>Expensive</p>
<p><b>TEMPORARY CULVERTS FOR MAJOR ROADS</b></p> 	<p>Eliminates stream turbulence and turbidity Provides unobstructed passage for fish and other aquatic life Capacity for normal flow can be provided with storm water flowing over the roadway</p>	<p>Space not always available without conflicting with permanent structure work May be expensive, especially for larger sizes of pipe Subject to washout</p>
<p><b>ROCK-LINED LOW-LEVEL CROSSING</b></p> 	<p>Minimizes stream turbidity Inexpensive May also serve as ditch check or sediment trap</p>	<p>May not be fordable during rainstorms During periods of low flow, passage of fish may be blocked</p>

TABLE 3 (continued)  
Typical Erosion Control Practice





Treatment Practice	Advantages	Problems
DITCHES		
<p>CHECK DAMS</p> 	<p>Maintains low velocities Catches sediment Can be constructed of logs, shot rock, lumber, masonry or concrete, gabions, sand bags</p>	<p>Close spacing on steep grades Require clean-out Unless keyed at sides and bottom, erosion may occur</p>
<p>SEDIMENT TRAPS/ STRAW BALE FILTERS</p> 	<p>Can be located as necessary to collect sediment during construction Clean-out often can be done with on-the-job equipment Simple to construct</p>	<p>Little direction on spacing and size Sediment disposal may be difficult Specification must include provisions for periodic clean-out May require seeding, sodding or pavement when removed during final cleanup</p>
<p>SODDING</p> 	<p>Easy to place with a minimum of preparation Can be repaired during construction Immediate protection May be used on sides of paved ditches to provide increased capacity</p>	<p>Requires water during first few weeks Sod not always available Will not withstand high velocity or severe abrasion from sediment load</p>
<p>SEEDING WITH MULCH AND MATTING</p> 	<p>Usually least expensive Effective for ditches with low velocity Easily placed in small quantities with inexperienced personnel</p>	<p>Will not withstand medium to high velocity Requires anchoring</p>
<p>PAVING, RIPRAP, RUBBLE</p>	<p>Effective for high velocities May be part of the permanent erosion control effort</p>	<p>Cannot always be placed when needed because of construction traffic and final grading and dressing Initial cost is high</p>

TABLE 3 (continued)  
Typical Erosion Control Practice

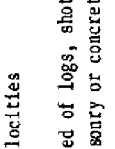

Treatment Practice	Advantages	Problems
ROADWAY SURFACE		
CROWNING TO DITCH OR SLOPING TO SINGLE BERM 	Directing the surface water to a prepared or protected ditch minimizes erosion	Requires good construction procedures Can cause local stability problems (sloughing)
COMPACTION	The final lift of each day's work should be well compacted and bladed to drain to ditch or berm section Loose or uncompacted material is more subject to erosion	Requires good construction procedures
AGGREGATE COVER	Minimizes surface erosion Permits construction traffic during adverse weather May be used as part of permanent base construction	Requires reworking and compaction if exposed for long periods of time Loss of surface aggregates can be anticipated
SEED/MULCH		Must be removed or is lost when construction of pavement is commenced
STONE FILLED GABION WALL		High cost Requires special techniques to install properly

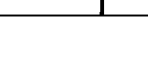
TABLE 3 (continued)  
Typical Erosion Control Practice



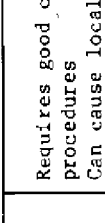

Treatment Practice	Advantages	Problems
CUT SLOPES		
<p><b>BERM AT TOP OF CUT</b></p> 	<p>Diverts water from cut Collects water for slope drains/paved ditches May be constructed before grading is started</p>	<p>Access to top of cut Difficult to build on steep natural slope or rock surface Concentrates water and may require channel protection or energy dissipation devices Can cause water to enter ground, resulting in sloughing of the cut slope</p>
<p><b>DIVERSION DIKE</b></p> 	<p>Collects and diverts water at a location selected to reduce erosion potential May be incorporated in the permanent project drainage</p>	<p>Access for construction May be continuing maintenance problem if not paved or protected Disturbed material or berm is easily eroded</p>
<p><b>SLOPE BENCHES</b></p> 	<p>Slows velocity of surface runoff Collects sediment Provides access to slope for seeding, mulching, and maintenance Collects water for slope drains or may divert water to natural ground</p>	<p>May cause sloughing of slopes if water infiltrates Requires additional construction area Not always possible due to poor material, etc. Requires maintenance to be effective Increases excavation quantities</p>
<p><b>SLOPE DRAINS (PIPE, PAVED, ETC)</b></p> 	<p>Prevents erosion on the slope Can be temporary or part of permanent construction Can be constructed or extended as grading progresses</p>	<p>Requires supporting effort to collect water Permanent construction is not always compatible with other project work Usually requires some type of energy dissipation</p>

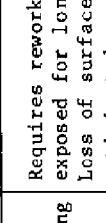
TABLE 3 (continued)  
Typical Erosion Control Practice



Treatment Practice	Advantages	Problems
<p>CUT SLOPES (continued)</p> <p><b>SEEDING/MULCHING</b></p> 	<p>The end objective is to have a completely grassed slope. Early placement is a step in this direction. The mulch provides temporary erosion protection until grass is rooted. Temporary or permanent seeding may be used. Mulch should be anchored. Larger slopes can be seeded and mulched with smaller equipment if stage techniques are used.</p>	<p>Difficult to schedule high production units for small increments Time of year may be less desirable May require supplemental water Contractor may perform this operation with untrained or unexperienced personnel and inadequate equipment if stage seeding is required</p>
<p><b>SODDING</b></p> 	<p>Provides immediate protection Can be used to protect adjacent property from sediment and turbidity</p>	<p>Difficult to place until cut is complete Sod not always available May be expensive</p>
<p><b>SLOPE PAVEMENT, RIPRAP</b></p> 	<p>Provides immediate protection for high risk areas and under structures May be cast in place or off site</p>	<p>Expensive Difficult to place on high slopes May be difficult to maintain</p>
<p><b>TEMPORARY COVER</b></p> 	<p>Plastics are available in wide rolls and large sheets that may be used to provide temporary protection for cut or fill slopes Easy to place and remove Useful to protect high risk areas from temporary erosion</p>	<p>Provides only temporary protection Original surface usually requires additional treatment when plastic is removed Must be anchored to prevent wind damage</p>

TABLE 3 (continued)  
Typical Erosion Control Practice

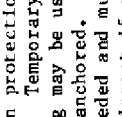
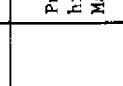
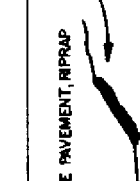

Treatment Practice	Advantages	Problems
CUT SLOPES (continued)		
<p><b>SERRATED SLOPE</b></p> 	<p>Lowers velocity of surface runoff Collects sediment Holds moisture Minimizes amount of sediment reaching roadside ditches</p>	<p>May cause minor sloughing if water infiltrates Construction compliance</p>
<p><b>FABRIC MATS</b></p> 	<p>Effective for moderate to high embankment when crown vetch plantings are used Has lower cost features over other methods</p>	<p>Requires anchoring time to promote plant growth. May require periodic maintenance</p>
BORROW AREAS		
<p><b>SELECTIVE GRADING AND SHAPING</b></p>	<p>Water can be directed to minimize off-site damage Flatter slopes enable mulch to be cut into soil</p>	<p>May not be most economical work method for contractor</p>
<p><b>STRIPPING AND REPLACING OF TOPSOIL</b></p>	<p>Provides better seed bed Conventional equipment can be used to stockpile and spread topsoil</p>	<p>May restrict volume of material that can be obtained for a site Topsoil stockpiles must be located to minimize sediment damage Cost of rehandling material</p>
<p><b>DINES, BERMS DIVERSION DITCHES SETTLING BASINS SEDIMENT TRAPS SEEDING &amp; MULCH</b></p>	<p>See other practices</p>	<p>See other practices</p>

TABLE 4  
Limiting Flow Velocities to Minimize Erosion

```

+))))))))))))))))))))))))))))))))))))))))))))))))))))))))))))))))))))))),
*
*
* PERMISSIBLE VELOCITY
*)))))))))))))))))))))))))))))))))))))))))))))))))))))))))))))))))))1
*
* With Channel Vegetation
*
* /))))))))))))))0))))))))))))))0))))))))))))))1
*
* Bare * 6" to 10" * 11" to 24" * Over 30" *
* Soil Type * Channel * in height * in height * in height *
/)))))))))))))))))))3))))))))))3))))))))))3))))))))))3))))))))))3))))))))))
*
* Sand, Silt, Sandy * 1.5 * 2.0 to 3.0 * 2.5 to 3.5 * 3.0 to 4.0 *
* loam, Silty loam * * * * *
*
* Silty clay loam, Silty * 2.0 * 3.0 to 4.0 * 3.5 to 4.5 * 4.0 to 5.0 *
* clay * * * * *
*
* Clay * 2.5 * 3.0 to 5.0 * 3.0 to 5.5 * 3.0 to 6.0 *
.)))))))))))))))))))2))))))))))2))))))))))2))))))))))2))))))))))2))))))))))-

```

5. SEDIMENT CONTROL. Typical sediment control practices are included in Table 3.

a. Traps. Traps are small and temporary, usually created by excavating and/or diking to a maximum height of five feet. Traps should be cleaned periodically.

b. Ponds.

(1) Size the outlet structure to accept the design storm.

(2) Size the pond length, width and depth to remove the desired percentage of sediment. See Figure 13 (modified after Reference 15, Trap Efficiency of Reservoirs, by Brune). For design criteria see Reference 16, Reservoir Sedimentation, by Gottschalk.

(3) If pond is permanent, compute volume of anticipated average annual sedimentation by the Universal Soil Loss Equation. Multiply by the number of years between pond cleaning and by a factor of safety. This equals minimum required volume below water level. Dimensions of the pond can then be calculated based on the available area. The design depth of the pond should be approximately three to five feet greater than the calculated depth of sediment at the time of clearing.

6. RIPRAP PROTECTION. Frequently coarse rock is placed on embankments where erodible soils must be protected from fast currents and wave action. When coarse rock is used, currents and waves may wash soil out from under the rock and lead to undermining and failure. Soil loss under rock slopes can be prevented by the use of filter fabrics or by the placement of a filter layer of intermediate sized material between the soil and rock. In some cases soil loss can be prevented by the use of well-graded rock containing suitable fines which work to the bottom during placement. For further guidance see Reference 17, Tentative Design Procedure for Rip Rap Lined Channels, by the Highway Research Board.

For determining rock sizes and filter requirements use Figure 14 (Reference 18, Design of Small Dams, by the Bureau of Reclamation).



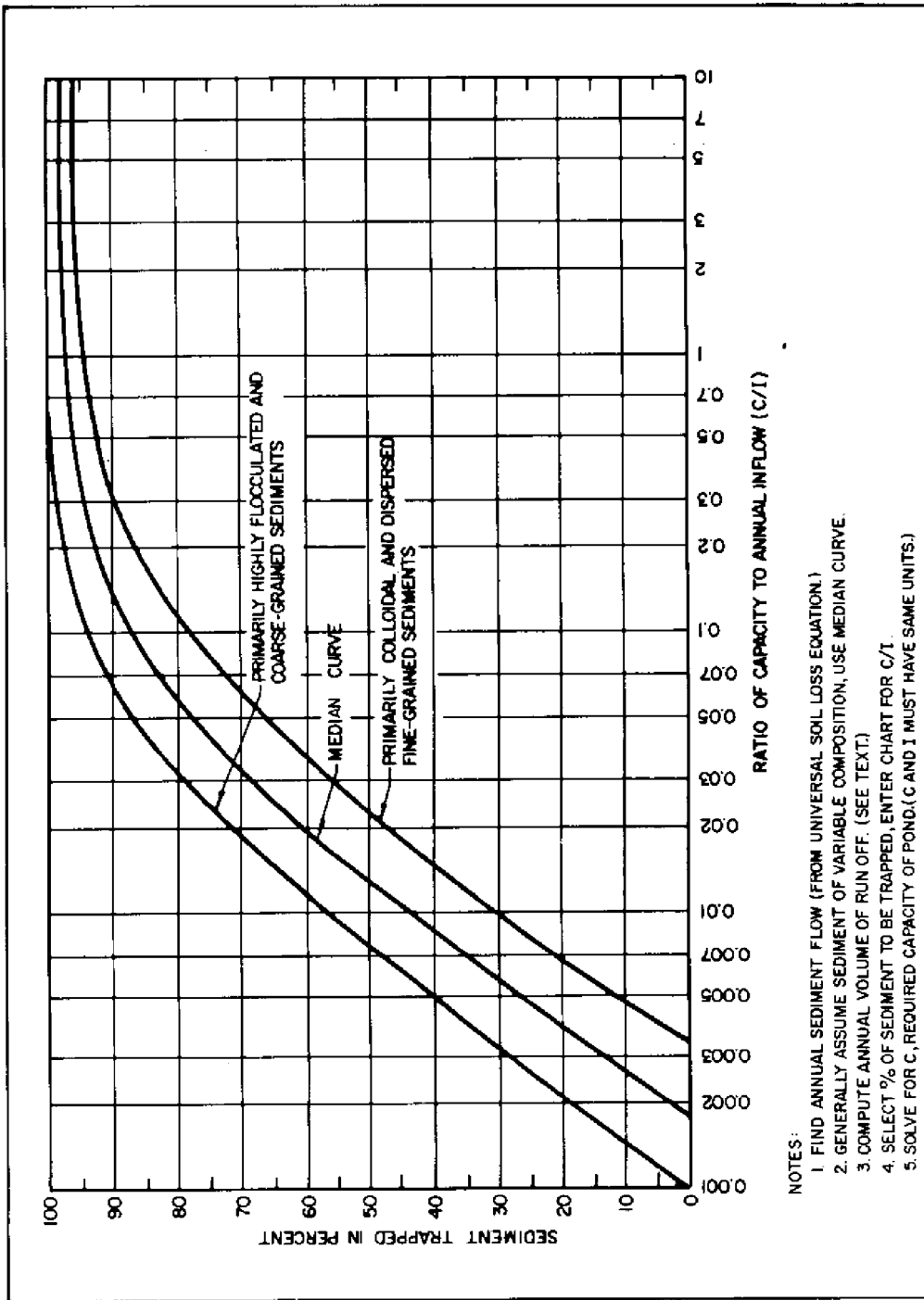

FIGURE 13  
Capacity of Sediment Control Ponds

```

+)))))))))))))))))))))))))))))))))))))))))))))))))))))))))))))))))))))))))))))))))))))))))))-,
*
*Example Calculation:
*
*   Annual soil loss in watershed = 0.9 acre-feet/year
*   (from Universal Soil Loss Equation or
*   other method, i.e. design charts)
*
*   Desired pond efficiency = 70% or 0.63 acre-feet of sediment
*   trapped each year.
*
*   Annual volume of runoff from watershed draining into
*   proposed pond = 400 acre-feet/yr.
*
*   For 70% efficiency using median curve C/I = 0.032
*   Required pond capacity C = 0.032 x 400 = 12.8 acre-feet.
*
*   Assuming average depth of pond of 6 ft, required pond
*   area about 2.1 acres. Pond should be cleaned when
*   capacity reduced 50%.
*
*   (Note: Trap efficiency decreases as volume of pond
*   decreases; this has not been considered in the example.)
*
*   Volume available for sediment = 50% x 12.8 = 6.4 acre-feet.
*
*   Years between cleaning =   6.4
*                           )))) [approximately] 10 years.
*                           0.63
.)))))))))))))))))))))))))))))))))))))))))))))))))))))))))))))))))))))))))))))))))))))))))))-

```

FIGURE 13 (continued)  
Capacity of Sediment Control Ponds

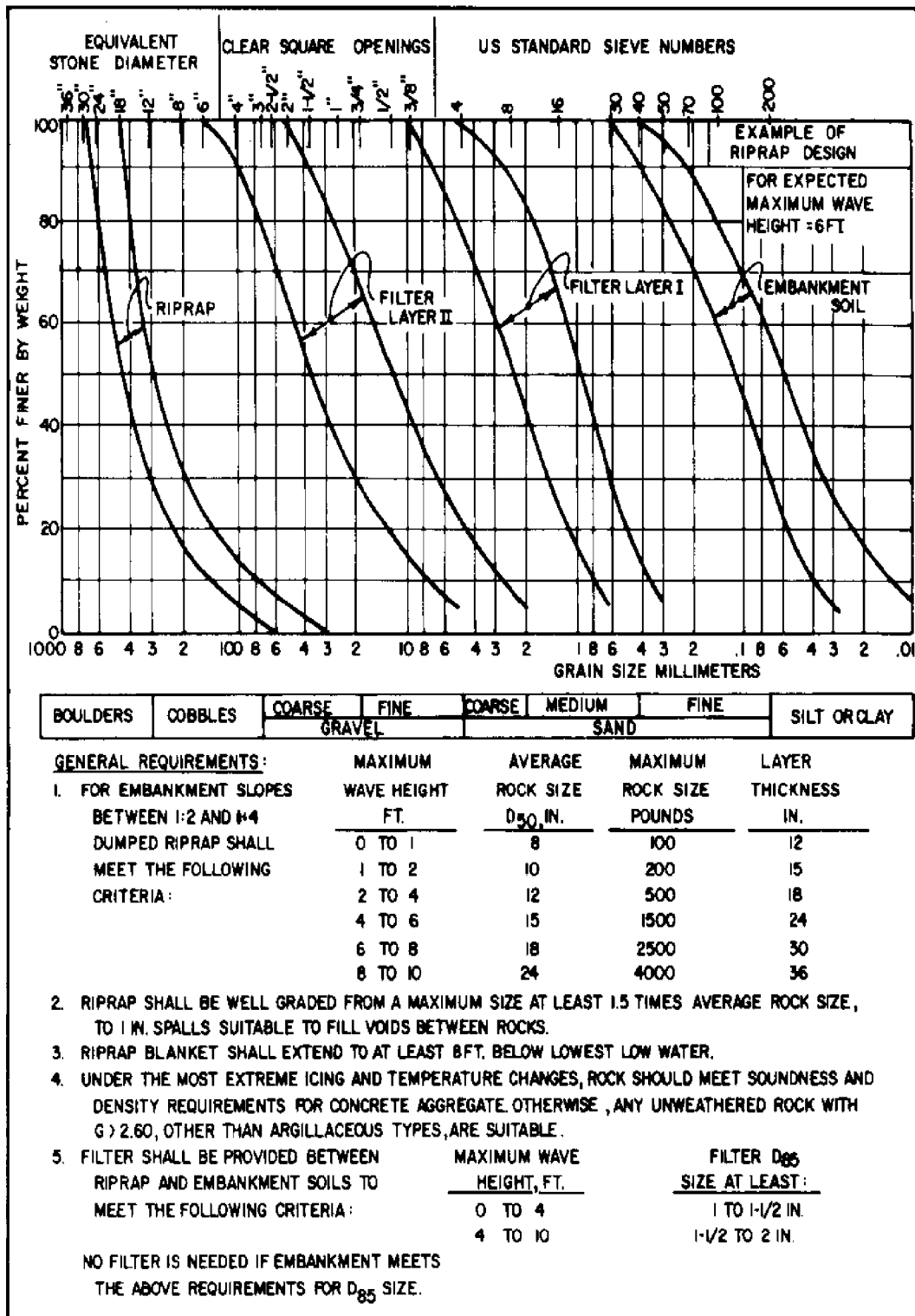

FIGURE 14  
 Design Criteria for Riprap and Filter on Earth Embankments

```

+))))))))))))))))))))))))))))))))))))))))))))))))))))))))))))))))))))))))))))))))))))))))))
* FILTER MAY NOT BE REQUIRED IF EMBANKMENT CONSISTS OF CH OR CL WITH LL) 30, *
* RESISTANT TO SURFACE EROSION. IF A FILTER IS USED IN THIS CASE IT *
* ORDINARILY MEETS FILTER CRITERIA AGAINST RIPRAP ONLY. *

* IF EMBANKMENT CONSISTS OF NONPLASTIC SOILS WHERE SEEPAGE WILL MOVE FROM *
* EMBANKMENT AT LOW WATER, 2 FILTER LAYERS MAY BE REQUIRED WHICH SHALL *
* MEET FILTER CRITERIA AGAINST BOTH EMBANKMENT AND RIPRAP. (EXAMPLE IS SHOWN*
* ABOVE). *
* 6. MINIMUM THICKNESS OF SINGLE LAYER MAXIMUM WAVE FILTER *
* FILTERS ARE AS FOLLOWS: HEIGHT, FT. THICKNESS, IN. *
* )))))))))))) )))))))))))) *
* 0 TO 4 6 *
* DOUBLE FILTER LAYERS SHOULD BE AT 4 TO 8 9 *
* LEAST 6 IN. THICK. 8 TO 12 12 *
*
.)))))

```

FIGURE 14 (continued)  
Design Criteria for Riprap and Filter on Earth Embankments

## REFERENCES

1. Lee, E. W., Security from Under Seepage of Masonary Dams on Earth Foundations, Transactions, ASCE, Volume 100, Paper 1919, 1935.
2. Marsland, A., Model Experiments to Study the Influence of Seepage on the Stability of a Sheeted Excavation in Sand, Geotechnique, 1952-1953.
3. Calhoun, C. C., Jr., Compton, J. R., Strohm, W. E. Jr., Performance of Plastic Filter Cloths as a Replacement for Granular Materials, Highway Research Record Number 373, Highway Research Board, 1971.
4. Koerner, R. M. and Welsh, J. P., Construction and Geotechnical Engineering Using Synthetic Fabrics, John Wiley & Sons, Inc., 1980.
5. Barber, E. W., Subsurface Drainage of Highways, Highway Research Board Bulletin 209, Highway Research Board, Washington, D.C.
6. Cedergren, H. R., Seepage Requirements of Filters and Pervious Bases, Journal of the Soil Mechanics and Foundation Division, ASCE, Vol. 86, No. SM5, 1960.
7. Kirkham, D., Seepage Into Ditches From a Plane Water Table Overlying a Gravel Substratum, Journal of Geophysical Research, American Geophysical Union, Washington, D.C., April, 1960.
8. Kirkham, D., Seepage Into Ditches in the Case of a Plane Water Table and an Impervious Substratum, Transactions, American Geophysical Union, Washington, D.C., June, 1950.
9. Avery, S. B., Analysis of Groundwater Lowering Adjacent to Open Water, Proceedings, ASCE, Vol 77, 1951.
10. Corps of Engineers, Soil Mechanics Design, Seepage Control, Engineering Manual, Civil Works Construction, Chapter I, Part CXIX, Department of the Army.
11. Cold Regions Research and Engineering Laboratory, Wastewater Stabilization Pond Linings, Special Report 28, Department of the Army, November, 1978.
12. Soil Conservation Service, U. S. Department of Agriculture, Urban Hydrology for Small Watersheds, Technical Release No. 55, Engineering Division, 1975.
13. Highway Research Board, Erosion Control on Highway Construction, National Cooperative Highway Research Program, Synthesis of Highway Practice 18, 1973.
14. Soil Conservation Service, U. S. Department of Agriculture, Minimizing Erosion in Urbanizing Areas, Madison, WI, 1972.

15. Brune, G. M., Trap Efficiency of Reservoirs, Transactions, American Geophysical Union, Volume 34, No. 3, June, 1953.
16. Gottschalk, L. C., Reservoir Sedimentation, Handbook of Applied Hydrology, Chow, Ed., Section 17-I, McGraw-Hill Book Company, 1964.
17. Highway Research Board, Tentative Design Procedure for Rip-Rap - Lined Channels, National Cooperative Highway Research Program Report 108, Washington, DC, 1970.
18. Bureau of Reclamation, Design of Small Dams, U.S. Department of the Interior, U. S. Government Printing Office, 1973.
19. Naval Facilities Engineering Command, Design Manuals (DM) and Publications (P).

DM-5.03	Drainage Systems
DM-21.06	Airfield Pavement Design for Frost Conditions and Subsurface Drainage
P-418	Dewatering and Groundwater Control

Copies of design manuals and publications may be obtained from the U. S. Naval Publications and Forms Center, 5801 Tabor Avenue, Philadelphia, Pennsylvania 19120.

PAGE 308 INTENTIONALLY BLANK

## CHAPTER 7. SLOPE STABILITY AND PROTECTION

### Section 1. INTRODUCTION

1. SCOPE. This chapter presents methods of analyzing stability of natural slopes and safety of embankments. Diagrams are included for stability analysis, and procedures for slope stabilization are discussed.
2. APPLICATIONS. Overstressing of a slope, or reduction in shear strength of the soil may cause rapid or progressive displacements. The stability of slopes may be evaluated by comparison of the forces resisting failure with those tending to cause rupture along the assumed slip surface. The ratio of these forces is the factor of safety.
3. RELATED CRITERIA. Excavations, Earth Pressures, Special Problems - See DM-7.2, Chapters 1, 2 and 3 and DM-7.3, Chapter 3.
4. REFERENCE. For detailed treatment on subject see Reference 1, Landslide Analyses and Control, by the Transportation Research Board.

### Section 2. TYPES OF FAILURES

1. MODES OF SLOPE FAILURE. Principal modes of failure in soil or rock are (i) rotation on a curved slip surface approximated by a circular arc, (ii) translation on a planar surface whose length is large compared to depth below ground, and (iii) displacement of a wedge-shaped mass along one or more planes of weakness. Other modes of failure include toppling of rockslopes, falls, block slides, lateral spreading, earth and mud flow in clayey and silty soils, and debris flows in coarse-grained soils. Tables 1 and 2 show examples of potential slope failure problems in both natural and man-made slopes.
2. CAUSES OF SLOPE FAILURE. Slope failures occur when the rupturing force exceeds resisting force.
  - a. Natural Slopes. Imbalance of forces may be caused by one or more of the following factors:
    - (1) A change in slope profile that adds driving weight at the top or decreases resisting force at the base. Examples include steepening of the slope or undercutting of the toe.
    - (2) An increase of groundwater pressure, resulting in a decrease of frictional resistance in cohesionless soil or swell in cohesive material. Groundwater pressures may increase through the saturation of a slope from rainfall or snowmelt, seepage from an artificial source, or rise of the water table.



TABLE I  
Analysis of Stability of Natural Slopes

<p>FAILURE OF THIN WEDGE, POSITION INFLUENCED BY TENSION CRACKS</p>  <p>FAILURE AT RELATIVELY SHALLOW TOE CIRCLES</p> <p>LOW GROUNDWATER      HIGH GROUNDWATER</p> <p>(1) SLOPE IN COARSE-GRAINED SOIL WITH SOME COHESION</p>	<p>WITH LOW GROUNDWATER, FAILURE OCCURS ON SHALLOW, STRAIGHT, OR SLIGHTLY CURVED SURFACE. PRESENCE OF A TENSION CRACK AT THE TOP OF THE SLOPE INFLUENCES FAILURE LOCATION. WITH HIGH GROUNDWATER, FAILURE OCCURS ON THE RELATIVELY SHALLOW TOE CIRCLE WHOSE POSITION IS DETERMINED PRIMARILY BY GROUND ELEVATION.</p> <p>ANALYZE WITH EFFECTIVE STRESSES USING STRENGTHS <math>c'</math> AND <math>\phi'</math> FROM CD TESTS. PORE PRESSURE IS GOVERNED BY SEEPAGE CONDITION. INTERNAL PORE PRESSURES AND EXTERNAL WATER PRESSURES MUST BE INCLUDED.</p>
<p>STABLE SLOPE ANGLE = EFFECTIVE FRICTION ANGLE</p>  <p>STABLE SLOPE ANGLE = 1/2 EFFECTIVE FRICTION ANGLE</p> <p>LOW GROUNDWATER      HIGH GROUNDWATER</p> <p>(2) SLOPE IN COARSE-GRAINED, COHESIONLESS SOIL</p>	<p>STABILITY DEPENDS PRIMARILY ON GROUNDWATER CONDITIONS. WITH LOW GROUNDWATER, FAILURES OCCUR AS SURFACE SLOUGHING UNTIL SLOPE ANGLE FLATTENS TO FRICTION ANGLE. WITH HIGH GROUNDWATER, STABLE SLOPE IS APPROXIMATELY 1/2 FRICTION ANGLE.</p> <p>ANALYZE WITH EFFECTIVE STRESSES USING STRENGTH <math>\phi'</math>. SLIGHT COHESION APPEARING IN TEST ENVELOPE IS IGNORED. SPECIAL CONSIDERATION MUST BE GIVEN TO POSSIBLE FLOW SLIDES IN LOOSE, SATURATED FINE SANDS.</p>
<p>LOCATION OF FAILURE DEPENDS ON VARIATION OF SHEAR STRENGTH WITH DEPTH</p>  <p>STRENGTH INCREASING WITH DEPTH</p> <p>STRENGTH CONSTANT WITH DEPTH</p> <p>STIFF OR HARD STRATUM</p> <p>(3) SLOPE IN NORMALLY CONSOLIDATED OR SLIGHTLY PRECONSOLIDATED CLAY</p>	<p>FAILURE OCCURS ON CIRCULAR ARCS WHOSE POSITION IS GOVERNED BY THEORY, SEE FIG. 3. POSITION OF GROUNDWATER TABLE DOES NOT INFLUENCE STABILITY UNLESS ITS FLUCTUATION CHANGES STRENGTH OF THE CLAY OR ACTS IN TENSION CRACKS.</p> <p>ANALYZE WITH TOTAL STRESSES, ZONING CROSS SECTION FOR DIFFERENT VALUES OF SHEAR STRENGTHS. DETERMINE SHEAR STRENGTH FROM UNCONFINED COMPRESSION TEST, UNCONSOLIDATED UNDRAINED TRIAXIAL TEST OR VANE SHEAR.</p>

TABLE 1 (continued)  
 Analysis of Stability of Natural Slopes

<p>LOCATION OF FAILURE DEPENDS ON RELATIVE STRENGTH AND ORIENTATION OF LAYERS</p>  <p>(4) SLOPE IN STRATIFIED SOIL PROFILE</p>	<p>LOCATION OF FAILURE PLANE IS CONTROLLED BY RELATIVE STRENGTH AND ORIENTATION OF STRATA. FAILURE SURFACE IS COMBINATION OF ACTIVE AND PASSIVE WEDGES WITH CENTRAL SLIDING BLOCK CHOSEN TO CONFORM TO STRATIFICATION.</p> <p>ANALYZE WITH EFFECTIVE STRESS USING <math>c'</math> AND <math>\phi'</math> FOR FINE-GRAINED STRATA AND <math>\phi'</math> FOR COHESIONLESS MATERIAL.</p>
<p>BOWL-SHAPED AREA OF LOW SLOPE (9 TO 11%) BOUNDED AT TOP BY OLD SCARP</p>  <p>(5) DEPTH CREEP MOVEMENTS IN OLD SLIDE MASS</p>	<p>STRENGTH OF OLD SLIDE MASS DECREASES WITH MAGNITUDE OF MOVEMENT THAT HAS OCCURRED PREVIOUSLY. MOST DANGEROUS SITUATION IS IN STIFF, OVER-CONSOLIDATED CLAY WHICH IS SOFTENED, FRACTURED, OR SLICKENSIDED IN THE FAILURE ZONE.</p>

TABLE 2  
 Analysis of Stability of Cut and Fill Slopes, Conditions Varying with Time

<p>LOCATION OF FAILURE DEPENDS ON GEOMETRY AND STRENGTH OF CROSS SECTION.</p>  <p>(1) FAILURE OF FILL ON SOFT COHESIVE FOUNDATION WITH SAND DRAINS</p>	<p>USUALLY MINIMUM STABILITY OCCURS DURING PLACING OF FILL. IF RATE OF CONSTRUCTION IS CONTROLLED, ALLOW FOR GAIN IN STRENGTH WITH CONSOLIDATION FROM DRAINAGE.</p> <p>ANALYZE WITH EFFECTIVE STRESS USING <math>c'</math> AND <math>\phi'</math> FROM CU TEST WITH PORE PRESSURE MEASUREMENT. APPLY ESTIMATED PORE PRESSURES OR PIEZOMETRIC PRESSURES. ANALYZE WITH TOTAL STRESS FOR RAPID CONSTRUCTION WITHOUT OBSERVATION OF PORE PRESSURES, USE SHEAR STRENGTH FROM UNCONFINED COMPRESSION OR UNCONSOLIDATED UNDRAINED TRIAXIAL.</p>
<p>FAILURE SURFACE MAY BE ROTATION ON CIRCULAR ARC OR TRANSLATION WITH ACTIVE AND PASSIVE WEDGES.</p>  <p>(2) FAILURE OF STIFF COMPACTED FILL ON SOFT COHESIVE FOUNDATION</p>	<p>USUALLY, MINIMUM STABILITY OBTAINED AT END OF CONSTRUCTION. FAILURE MAY BE IN THE FORM OF ROTATION OR TRANSLATION, AND BOTH SHOULD BE CONSIDERED.</p> <p>FOR RAPID CONSTRUCTION IGNORE CONSOLIDATION FROM DRAINAGE AND UTILIZE SHEAR STRENGTHS DETERMINED FROM U OR UU TESTS OR VANE SHEAR IN TOTAL STRESS ANALYSIS. IF FAILURE STRAIN OF FILL AND FOUNDATION MATERIALS DIFFER GREATLY, SAFETY FACTOR SHOULD EXCEED ONE, IGNORING SHEAR STRENGTH OF FILL. ANALYZE LONG-TERM STABILITY USING <math>c</math> AND <math>\phi</math> FROM CU TESTS WITH EFFECTIVE STRESS ANALYSIS, APPLYING PORE PRESSURES OF GROUNDWATER ONLY.</p>
<p>ORIGINAL GROUND LINE</p> <p>CUT AT TOE</p>  <p>FAILURE SURFACE DEPENDS ON PATTERN OF FISSURES OR DEPTH OF SOFTENING.</p> <p>(3) FAILURE FOLLOWING CUT IN STIFF FISSURED CLAY</p>	<p>RELEASE OF HORIZONTAL STRESSES BY EXCAVATION CAUSES EXPANSION OF CLAY AND OPENING OF FISSURES, RESULTING IN LOSS OF COHESIVE STRENGTH.</p> <p>ANALYZE FOR SHORT TERM STABILITY USING <math>c'</math> AND <math>\phi'</math> WITH TOTAL STRESS ANALYSIS. ANALYZE FOR LONG TERM STABILITY WITH <math>c'_r</math> AND <math>\phi'_m</math> BASED ON RESIDUAL STRENGTH MEASURED IN CONSOLIDATED DRAINED TESTS.</p>

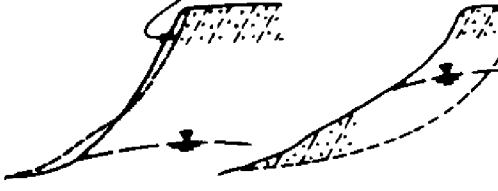
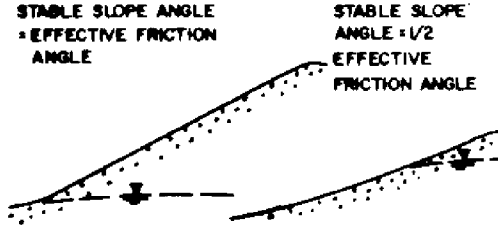
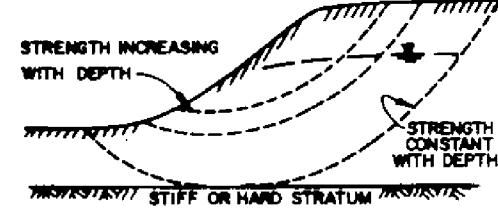
(3) Progressive decrease in shear strength of the soil or rock mass caused by weathering, leaching, mineralogical changes, opening and softening of fissures, or continuing gradual shear strain (creep).

(4) Vibrations induced by earthquakes, blasting, or pile-driving. Induced dynamic forces cause densification of loose sand, silt, or loess below the groundwater table or collapse of sensitive clays, causing increased pore pressures. Cyclic stresses induced by earthquakes may cause liquefaction of loose, uniform, saturated sand layers (see DM-7.3, Chapter 1).

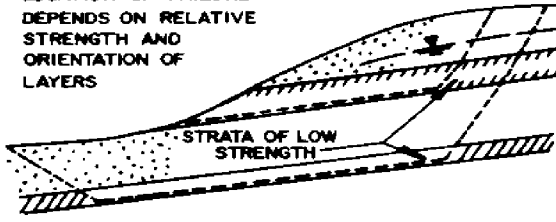
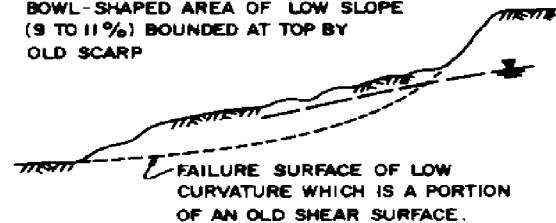
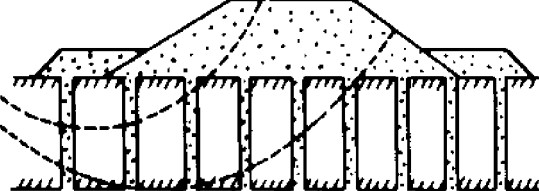
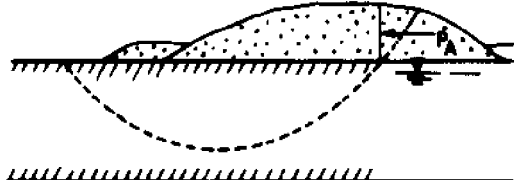
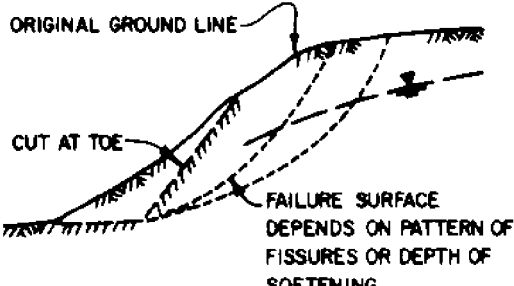
b. Embankment (Fill) Slopes. Failure of fill slopes may be caused by one or more of the following factors:

(1) Overstressing of the foundation soil. This may occur in cohesive soils, during or immediately after embankment construction. Usually, the short-term stability of embankments on soft cohesive soils is more critical than the long-term stability, because the foundation soil will gain strength as the pore water pressure dissipates. It may, however, be necessary to check the stability for a number of pore pressure conditions. Usually, the critical failure surface is tangent to the firm layers below the soft subsoils.

(2) Drawdown and Piping. In earth dams, rapid drawdown of the reservoir causes increased effective weight of the embankment soil thus reducing stability. Another potential cause of failure in embankment slopes is subsurface erosion or piping (see Chapter 6 for guidance on prevention of piping).

(3) Dynamic Forces. Vibrations may be induced by earthquakes, blasting, pile driving, etc.

c. Excavation (Cut) Slopes. Failure may result from one or more of the factors described in (a). An additional factor that should be considered for cuts in stiff clays is the release of horizontal stresses during excavation which may cause the formation of fissures. If water enters the fissures, the strength of the clay will decrease progressively. Therefore, the long-term stability of slopes excavated in cohesive soils is normally more critical than the short-term stability. When excavations are open over a long period and water is accessible, there is potential for swelling and loss of strength with time.

### 3. EFFECT OF SOIL OR ROCK TYPE.

a. Failure Surface. In homogeneous cohesive soils, the critical failure surface usually is deep whereas shallow surface sloughing and sliding is more typical in homogeneous cohesionless soils. In nonhomogeneous soil foundations the shape and location of the failure depends on the strength and stratification of the various soil types.

b. Rock. Slope failures are common in stratified sedimentary rocks, in weathered shales, and in rocks containing platy minerals such as talc, mica, and the serpentine minerals. Failure planes in rock occur along zones of weakness or discontinuities (fissures, joints, faults) and bedding planes (strata). The orientation and strength of the discontinuities are the most

important factors influencing the stability of rock slopes. Discontinuities can develop or strength can change as a result of the following environmental factors:

- (1) Chemical weathering.
- (2) Freezing and thawing of water/ice in joints.
- (3) Tectonic movements.
- (4) Increase of water pressures within discontinuities.
- (5) Alternate wetting and drying (especially expansive shales).
- (6) Increase of tensile stresses due to differential erosion.

Further guidance pertinent to rock slopes can be found in DM-7.2, Chapter 1.

### Section 3. METHODS OF ANALYSIS

1. TYPES OF ANALYSIS. For slopes in relatively homogeneous soil, the failure surface is approximated by a circular arc, along which the resisting and rupturing forces can be analyzed. Various techniques of slope stability analysis may be classified into three broad categories.

a. Limit Equilibrium Method. Most limit equilibrium methods used in geotechnical practice assume the validity of Coulomb's failure criterion along an assumed failure surface. A free body of the slope is considered to be acted upon by known or assumed forces. Shear stresses induced on the assumed failure surface by the body and external forces are compared with the available shear strength of the material. This method does not account for the load deformation characteristics of the materials in question. Most of the methods of stability analysis currently in use fall in this category.

The method of slices, which is a rotational failure analysis, is most commonly used in limit equilibrium solutions. The minimum factor of safety is computed by trying several circles. The difference between various approaches stems from (a) the assumptions that make the problem determinate, and (b) the equilibrium conditions that are satisfied. The soil mass within the assumed slip surface is divided into several slices, and the forces acting on each slice are considered. The effect of an earthquake may be considered by applying appropriate horizontal force on the slices. Figure 1 (Reference 2, Soil Mechanics, by Lambe and Whitman) illustrates this method of analysis applied to a slope of homogeneous sandy soil subjected to the forces of water seeping laterally toward a drain at the toe.

b. Limit Analysis. This method considers yield criteria and the stress-strain relationship. It is based on lower bound and upper bound theorems for bodies of elastic - perfectly plastic materials. See Reference 3, Stability of Earth Slopes, by Fang, for further guidance.

Considering the equilibrium of forces in the vertical direction but neglecting the shearing forces between slices the factor of safety for moment equilibrium becomes (neglecting earthquake forces):

$$F_m = \frac{\sum_{i=1}^{i=N} [\bar{c}b_i + (W_i - u_i b_i) \tan \bar{\phi}] / M_{\alpha_i}}{\sum_{i=1}^{i=N} W_i \sin \alpha_i}$$

$$\text{WHERE } M_{\alpha_i} = \cos \alpha_i \left( 1 + \frac{\tan \alpha_i \tan \bar{\phi}}{F_m} \right)$$

The above equation is solved by successive approximations. Value of  $M_{\alpha_i}$  is obtained from Figure 1 (continued) Graph for Determination of  $M_{\alpha}$  for an assumed value of  $F_m$ .

Example:

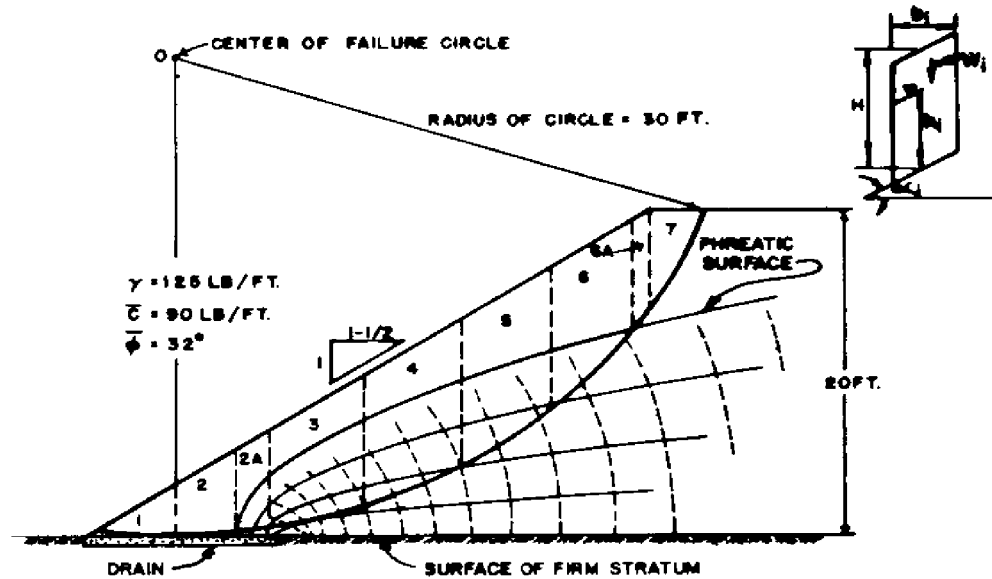

Find  $F_m$  for the trial slip circle shown.

Properties

$$\bar{c} = 90 \text{ psf}, \quad \bar{\phi} = 32^\circ, \quad \gamma = 125 \text{ PCF}$$

Slope 1-1/2 horizontal to 1 vertical.

Flow conditions as shown.

FIGURE 1  
Method of Slices - Simplified Bishop Method (Circular Slip Surface)

Procedure (numbers in parenthesis corresponds to column in example):

1. Divide cross section into vertical slices, (1).
2. Calculate weight of each slice ( $W_i$ ) using total unit weights, where  $b_i$  is the width of the slice and  $H$  is the average height of the slice, (2), (3), (4).
3. Calculate  $W_i \sin \alpha_i$  for each slice, where  $\alpha_i$  is the angle between the tangent of the failure surface and the horizontal, (5)(6).
4. Multiply the cohesive strength ( $\bar{c}$ ) times the width of each slice ( $b_i$ ), (7).
5. Multiply the average pore water pressure [ $(u_i) = (h_i)(.0624 \text{ KSF})$ ] along the failure surface of each slice, times the width of each slice, (8).
6. Calculate  $(W_i - u_i b_i) \tan \bar{\theta}$  for each slice, (9).
7. Add  $\bar{c} b_i$  plus  $(W_i - u_i b_i) \tan \bar{\theta}$  for each slice, (10).
8. Select two factors of safety ( $F_m$ ), and find  $M \alpha_i$  for each slice using graph below (11).
9. Divide  $\bar{c} b_i + (W_i - u_i b_i) \tan \bar{\theta}$  by  $M \alpha_i$  for each slice and sum resultants, (12).
10. Divide  $\sum_{i=1}^{i=n} \frac{\bar{c} b_i + (W_i - u_i b_i) \tan \bar{\theta}}{M \alpha_i}$  by  $\sum_{i=1}^{i=n} W_i \sin \alpha_i$  to obtain calculated  $F_m$ .  
Compare to  $F_m$ 's assumed in Step 8. Reiterate Steps 8, 9, and 10 until assumed  $F_m$  of Step 8 equals calculated  $F_m$  of Step 10.
11. Repeat above analysis varying center location and radius of failure circle to establish least factor of safety.

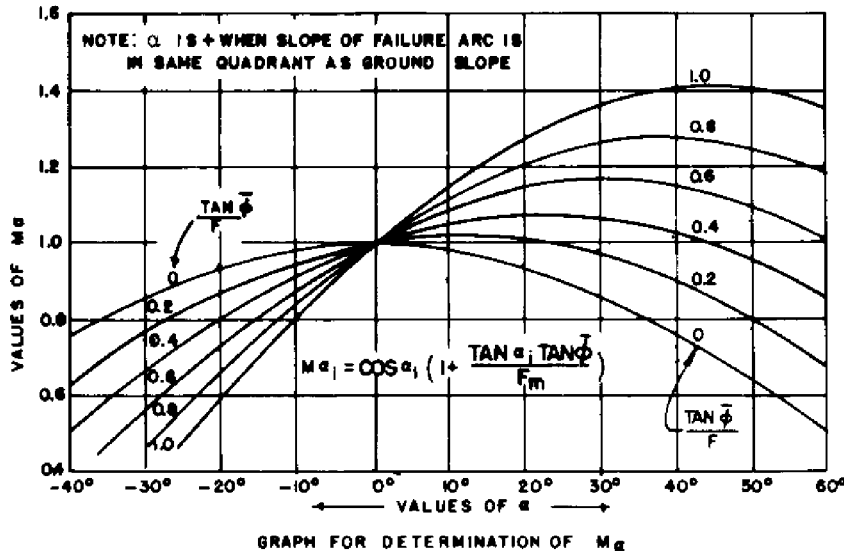

FIGURE 1 (continued)  
Method of Slices - Simplified Bishop Method (Circular Slip Surface)

Slice (1)	$d_i$ (FT) (2)	H (FT) (3)	$W_i$ (KIPS) (4)	$\sin \alpha_i$ (5)	$W_i \sin \alpha_i$ (KIPS) (6)	$\bar{c}_i$ (KIPS) (7)	$u_i b_i$ (KIPS) (8)	$(W_i - u_i b_i)$ $\text{TAN } \bar{\phi}$ (KIPS) (9)	(7+9) (KIPS) (10)	$M \alpha_i$ $\frac{F_m^2}{1.25}$ (11)	(10) + (11) $\frac{F_m^2}{1.25}$ (12)
1	4.5	1.6	0.9	0.03	0	0.40	0	0.55	0.95	0.97	1.00
2	3.2	4.2	1.7	0.05	0.1	0.29	0	1.05	1.35	1.02	1.30
2A	1.8	5.8	1.3	0.14	0.2	0.16	0.05	0.80	0.95	1.06	0.90
3	5.0	7.4	4.6	0.25	1.2	0.45	1.05	2.25	2.70	1.09	2.50
4	5.0	9.0	5.6	0.42	2.3	0.45	1.45	2.55	3.00	1.12	2.70
5	5.0	9.3	5.8	0.58	3.4	0.45	1.25	2.70	3.15	1.10	2.85
6	4.4	8.4	4.6	0.74	3.4	0.40	0.50	2.65	3.05	1.05	2.90
6A	0.6	6.7	0.5	0.82	0.4	0.05	0	0.30	0.35	0.98	0.40
7	3.2	3.8	1.5	0.87	1.3	0.29	0	0.95	1.25	0.93	1.35
				12.3							15.80
											16.05

For assumed  $F_m = 1.25$ , calculated,  $F_m = \frac{15.8}{12.3} = 1.29$

$F_m = 1.35$ , calculated,  $F_m = \frac{16.05}{12.3} = 1.31$

A trial assuming  $F = 1.3$  would yield  $F_m = 1.3$

FIGURE 1 (continued)  
Method of Slices - Simplified Bishop Method (Circular Slip Surface)



c. Finite Element Method. This method is extensively used in more complex problems of slope stability and where earthquake and vibrations are part of total loading system. This procedure accounts for deformation and is useful where significantly different material properties are encountered.

2. FAILURE CHARACTERISTICS. Table 1 shows some situations that may arise in natural slopes. Table 2 shows situations applicable to man-made slopes. Strength parameters, flow conditions, pore water pressure, failure modes, etc. should be selected as described in Section 4.

3. SLOPE STABILITY CHARTS.

a. Rotational Failure in Cohesive Soils ( $[\phi] = 0$ )

(1) For slopes in cohesive soils having approximately constant strength with depth use Figure 2 (Reference 4, Stability Analysis of Slopes with Dimensionless Parameters, by Janbu) to determine the factor of safety.

(2) For slope in cohesive soil with more than one soil layer, determine centers of potentially critical circles from Figure 3 (Reference 4). Use the appropriate shear strength of sections of the arc in each stratum. Use the following guide for positioning the circle.

(a) If the lower soil layer is weaker, a circle tangent to the base of the weaker layer will be critical.

(b) If the lower soil layer is stronger, two circles, one tangent to the base of the upper weaker layer and the other tangent to the base of the lower stronger layer, should be investigated.

(3) With surcharge, tension cracks, or submergence of slope, apply corrections of Figure 4 to determine safety factor.

(4) Embankments on Soft Clay. See Figure 5 (Reference 5, The Design of Embankments on Soft Clays, by Jakobsen) for approximate analysis of embankment with stabilizing berms on foundations of constant strength. Determine the probable form of failure from relationship of berm and embankment widths and foundation thickness in top left panel of Figure 5.

4. TRANSLATIONAL FAILURE ANALYSIS. In stratified soils, the failure surface may be controlled by a relatively thin and weak layer. Analyze the stability of the potentially translating mass as shown in Figure 6 by comparing the destabilizing forces of the active pressure wedge with the stabilizing force of the passive wedge at the toe plus the shear strength along the base of the central soil mass. See Figure 7 for an example of translational failure analysis in soil and Figure 8 for an example of translational failure in rock.

Jointed rocks involve multiple planes of weakness. This type of problem cannot be analyzed by two-dimensional cross-sections. See Reference 6, The Practical and Realistic Solution of Rock Slope Stability, by Von Thun.

5. REQUIRED SAFETY FACTORS. The following values should be provided for reasonable assurance of stability:

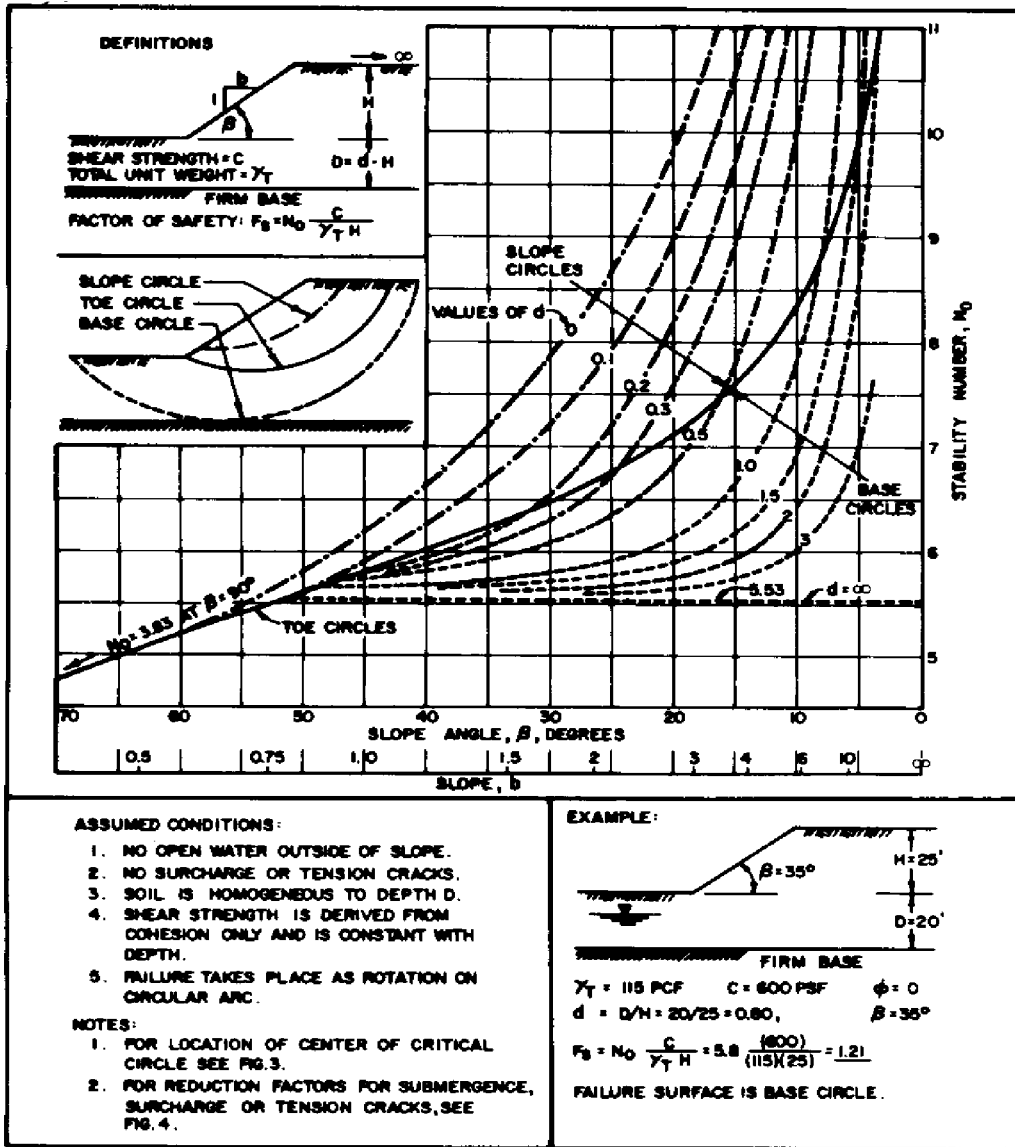

FIGURE 2  
 Stability Analysis for Slopes in Cohesive Soils, Undrained Conditions,  
 i.e., Assumed  $\phi = 0$

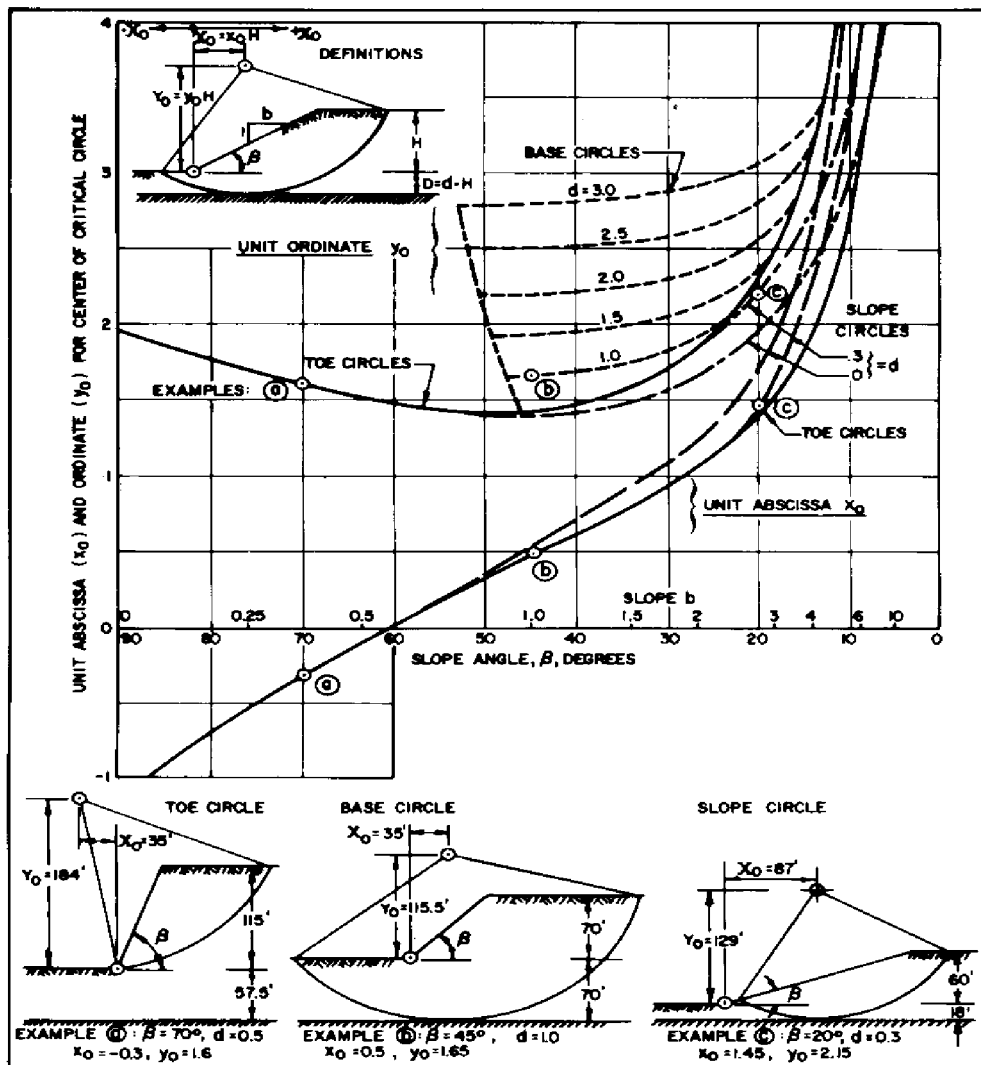

FIGURE 3  
Center of Critical Circle, Slope in Cohesive Soil

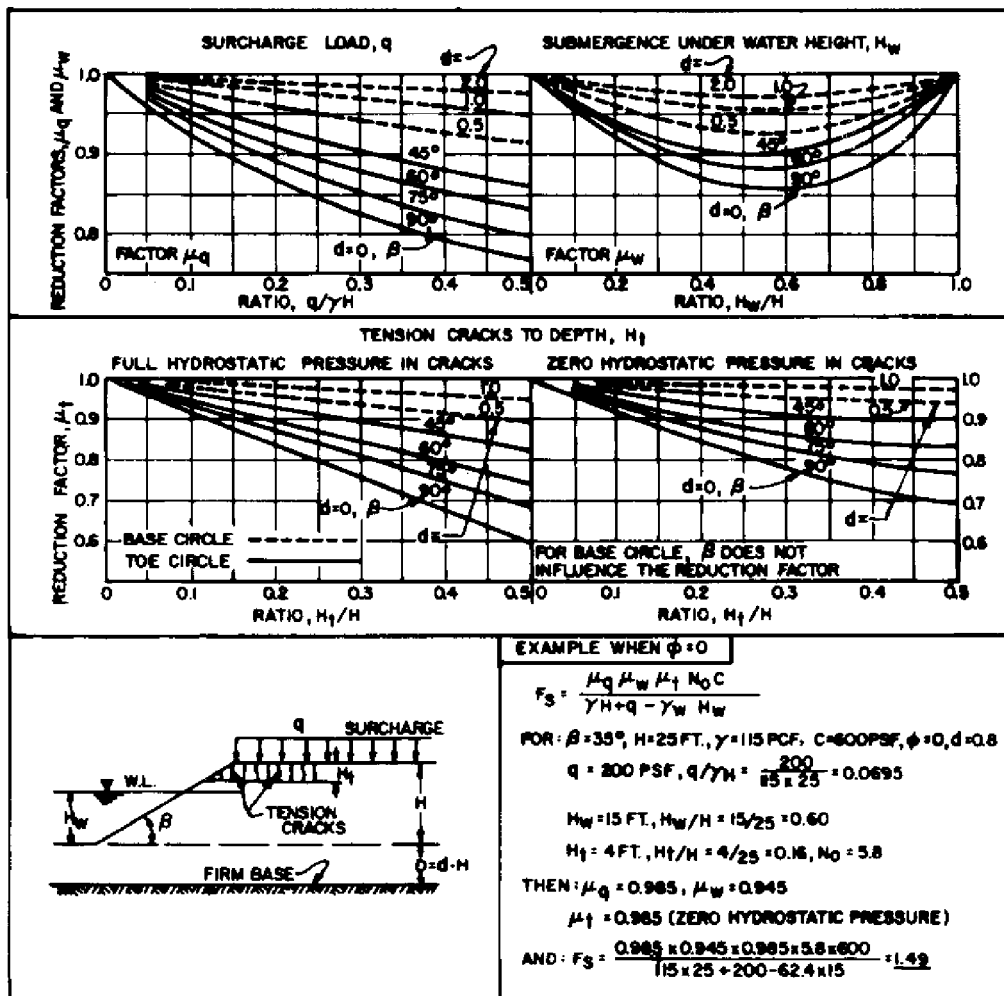

FIGURE 4  
Influence of Surcharge, Submergence, and Tension Cracks on Stability

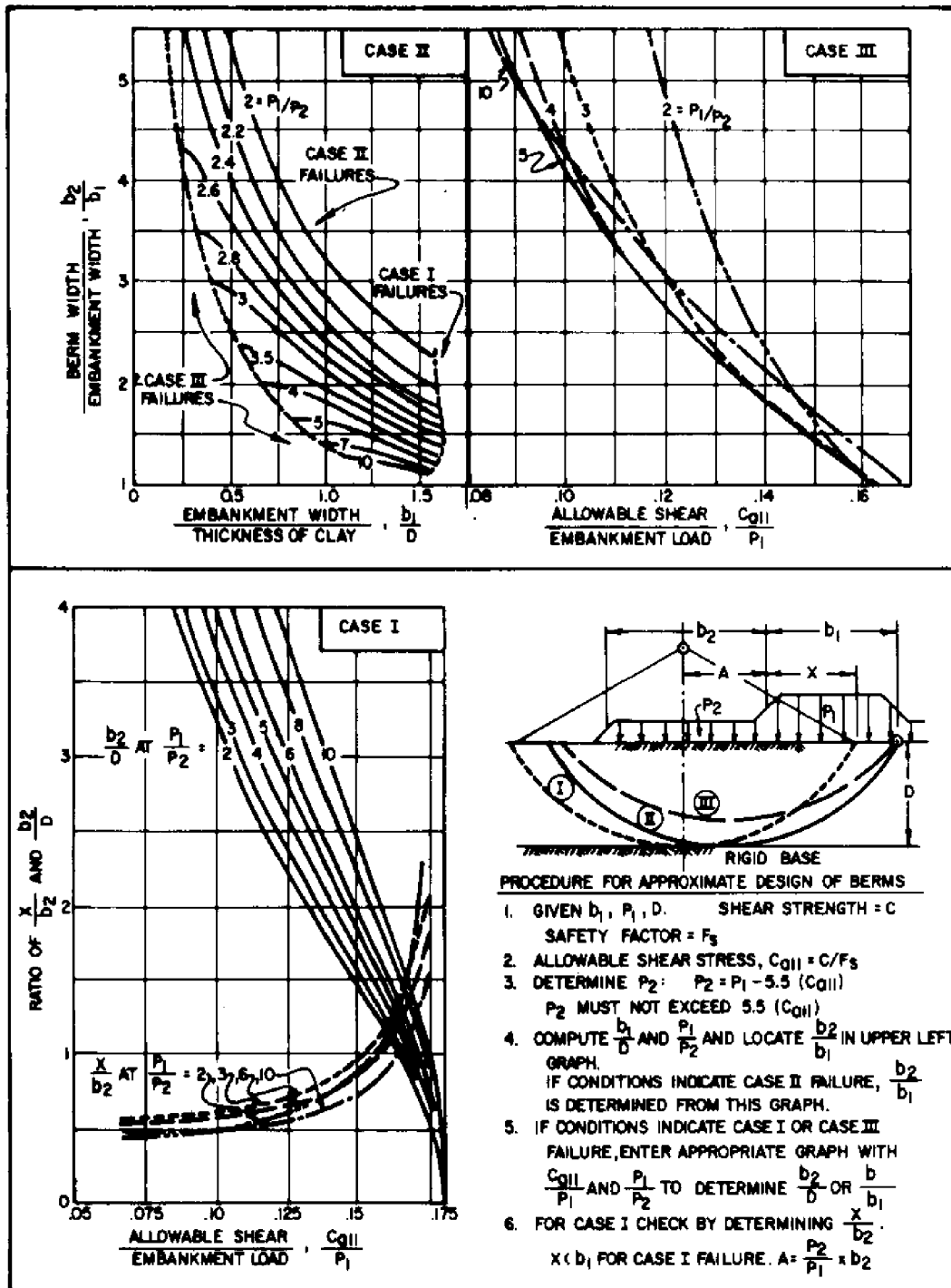

FIGURE 5  
Design of Berms for Embankments on Soft Clays

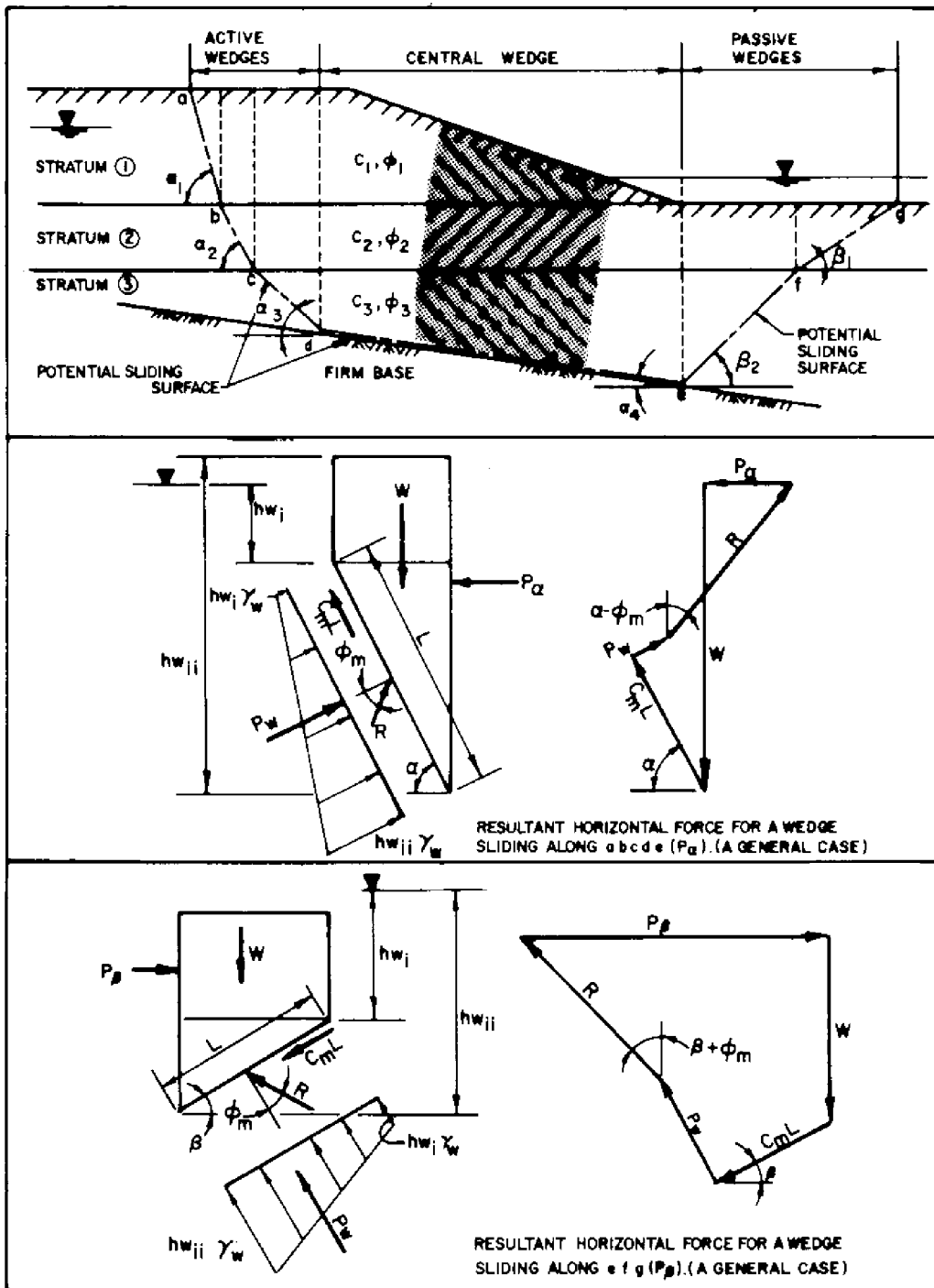

FIGURE 6  
Stability Analysis of Translational Failure

**DEFINITION OF TERMS**

- $P_a$  = RESULTANT HORIZONTAL FORCE FOR AN ACTIVE OR CENTRAL WEDGE ALONG POTENTIAL SLIDING SURFACE a b c d e .
- $P_B$  = RESULTANT HORIZONTAL FORCE FOR A PASSIVE WEDGE ALONG POTENTIAL SLIDING SURFACE e f g .
- W = TOTAL WEIGHT OF SOIL AND WATER IN WEDGE ABOVE POTENTIAL SLIDING SURFACE.
- R = RESULT OF NORMAL AND TANGENTIAL FORCES ON POTENTIAL SLIDING SURFACE CONSIDERING FRICTION ANGLE OF MATERIAL.
- $P_w$  = RESULTANT FORCE DUE TO PORE WATER PRESSURE ON POTENTIAL SLIDING SURFACE CALCULATED AS :  

$$P_w = \left[ \frac{h_{wi} + h_{wi}}{2} \right] (L)(\gamma_w)$$
- $\phi$  = FRICTION ANGLE OF LAYER ALONG POTENTIAL SLIDING SURFACE.
- C = COHESION OF LAYER ALONG POTENTIAL SLIDING SURFACE .
- L = LENGTH OF POTENTIAL SLIDING SURFACE ACROSS WEDGE.
- $h_w$  = DEPTH BELOW PHREATIC SURFACE AT BOUNDARY OF WEDGE.
- $\gamma_w$  = UNIT WEIGHT OF WATER .

**PROCEDURES**

- 1.) EXCEPT FOR CENTRAL WEDGE WHERE  $\alpha$  IS DICTATED BY STRATIGRAPHY USE  $\alpha = 45^\circ + \frac{\phi}{2}$ ,  $\beta = 45^\circ - \frac{\phi}{2}$  FOR ESTIMATING FAILURE SURFACE.
- 2.) SOLVE FOR  $P_a$  AND  $P_B$  FOR EACH WEDGE IN TERMS OF THE SAFETY FACTOR ( $F_s$ ) USING THE EQUATIONS SHOWN BELOW. THE SAFETY FACTOR IS APPLIED TO SOIL STRENGTH VALUES ( $\tan \phi$  AND C).  
 MOBILIZED STRENGTH PARAMETERS ARE THEREFORE CONSIDERED AS  $\phi_m = \tan^{-1} \left( \frac{\tan \phi}{F_s} \right)$  AND  $C_m = \frac{C}{F_s}$ .

$$P_a = [W - C_m L \sin \alpha - P_w \cos \alpha] \tan [\alpha - \phi_m] - [C_m L \cos \alpha - P_w \sin \alpha]$$

$$P_B = [W + C_m L \sin \beta - P_w \cos \beta] \tan (\beta + \phi_m) + [C_m L \cos \beta + P_w \sin \beta]$$

IN WHICH THE FOLLOWING EXPANSIONS ARE TO BE USED:

$$\tan (\alpha - \phi_m) = \frac{\tan \alpha - \frac{\tan \phi}{F_s}}{1 + \tan \alpha \frac{\tan \phi}{F_s}} \quad \tan (\beta + \phi_m) = \frac{\tan \beta + \frac{\tan \phi}{F_s}}{1 - \tan \beta \frac{\tan \phi}{F_s}}$$

- 3.) FOR EQUILIBRIUM  $\Sigma P_a = \Sigma P_B$ . SUM  $P_a$  AND  $P_B$  FORCES IN TERMS OF  $F_s$ , SELECT TRIAL  $F_s$ , CALCULATE  $\Sigma P_a$  AND  $\Sigma P_B$ . IF  $\Sigma P_a \neq \Sigma P_B$ , REPEAT. PLOT  $P_a$  AND  $P_B$  VS.  $F_s$  WITH SUFFICIENT TRIALS TO ESTABLISH THE POINT OF INTERSECTION (i.e.,  $\Sigma P_a = \Sigma P_B$ ), WHICH IS THE CORRECT SAFETY FACTOR.
- 4.) DEPENDING ON STRATIGRAPHY AND SOIL STRENGTH, THE CENTER WEDGE MAY ACT TO MAINTAIN OR UPSET EQUILIBRIUM.
- 5.) NOTE THAT FOR  $\phi = 0$ , ABOVE EQUATIONS REDUCE TO:  

$$P_a = W \tan \alpha - \frac{C_m L}{\cos \alpha} \quad , \quad P_B = W \tan \beta + \frac{C_m L}{\cos \beta}$$
- 6.) THE SAFETY FACTOR FOR SEVERAL POTENTIAL SLIDING SURFACES MAY HAVE TO BE COMPUTED IN ORDER TO FIND THE MINIMUM SAFETY FACTOR FOR THE GIVEN STRATIGRAPHY.

FIGURE 6 (continued)  
 Stability Analysis of Translational Failure

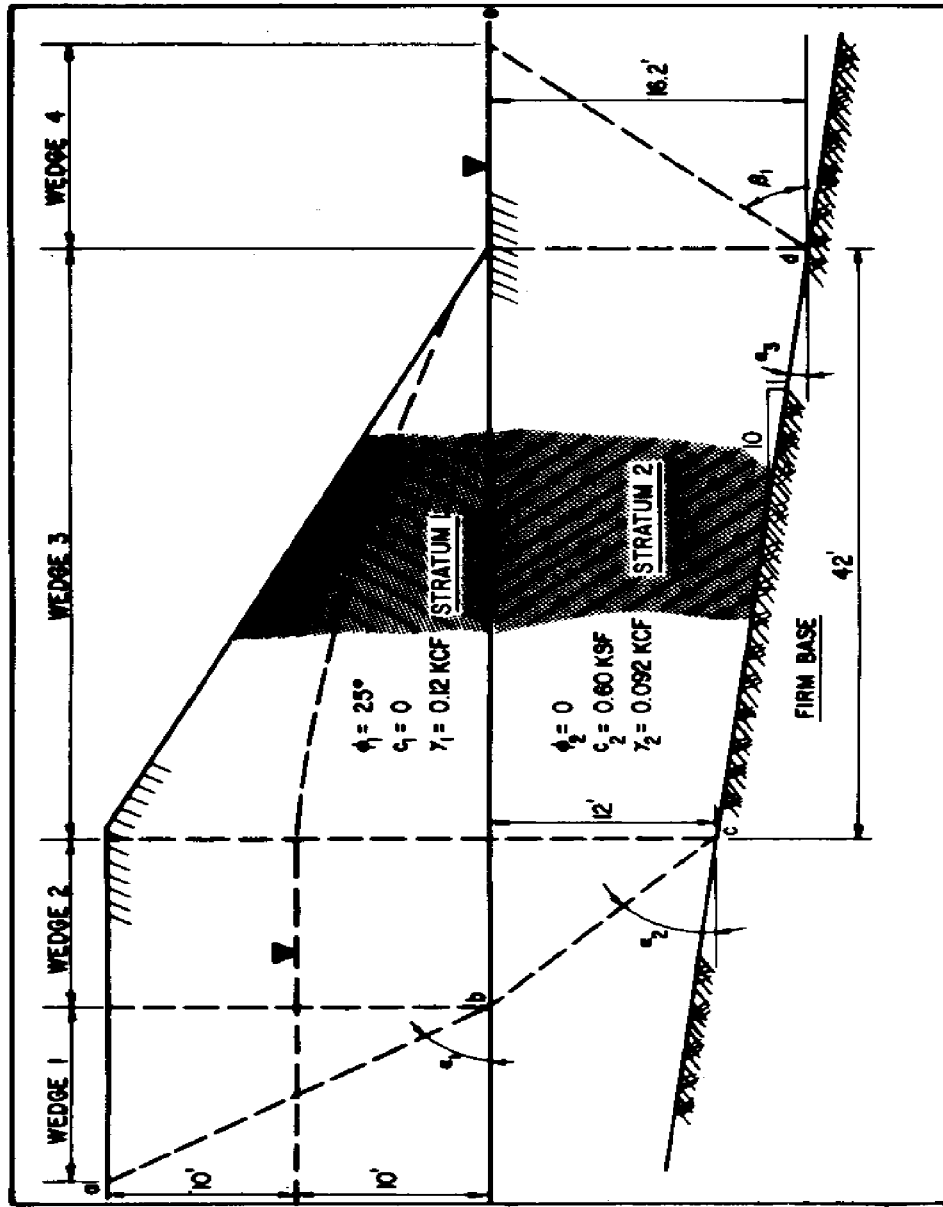

FIGURE 7  
 Example of Stability Analysis of Translational Failure



**FORCES  $P_a$**

WEDGE 1:  $\phi = 25^\circ, C = 0, \gamma = 0.12 \text{ KCF}$  (SLIDING SURFACE ab)

$$\alpha_1 = 45 + \phi_1/2 = 57.5^\circ$$

$$W = \frac{20}{2} \times 20 \tan 32.5^\circ \times 0.12 = 15.29 \text{ KIPS}$$

$$P_w = \left(\frac{0+10}{2}\right) (0.062) \times \left(\frac{10}{\sin 57.5^\circ}\right) = 3.68 \text{ KIPS}$$

$$P_{a1} = (W - P_w \cos \alpha_1) \left( \frac{\tan \alpha_1 - \frac{F_s}{F_s}}{1 + \tan \alpha_1 \frac{F_s}{F_s}} \right) + P_w \sin \alpha_1$$

$$= (15.29 - 1.98) \left( \frac{1.57 - \frac{0.47}{F_s}}{1 + \frac{0.73}{F_s}} \right) + 3.10 \times \left( \frac{20.90 F_s - 6.26}{F_s + 0.73} \right) + 3.10$$

WEDGE 2:  $\phi = 0, C = 0.60 \text{ KSF}, \gamma = 0.092 \text{ KCF}$  (SLIDING SURFACE bc)

$$\alpha_2 = 45^\circ$$

$$W = 12 \times 10 \times 0.12 + 12 \times 10 \times 0.12 + \frac{12}{2} \times 12 \times 0.092 = 35.42 \text{ KIPS}$$

$$P_{a2} = W \tan \alpha_2 - \frac{C \cdot L}{\cos \alpha_2} \quad (\text{FOR } \phi = 0)$$

$$= 35.42 - \frac{(0.60 \times 12)}{(0.707)} = 35.42 - \frac{14.40}{F_s}$$

WEDGE 3:  $\phi = 0, C = 0.60 \text{ KSF}, \gamma = 0.092 \text{ KCF}$  (SLIDING SURFACE cd)

$$\alpha_3 = \tan^{-1} 0.1 = 5.7^\circ$$

$$W = \frac{20}{2} \times 42 \times 0.12 + \frac{12 + 16.2}{2} \times 42 \times 0.092 = 104.88 \text{ KIPS}$$

$$P_{a3} = W \tan \alpha_3 - \frac{C \cdot L}{\cos \alpha_3} \quad (\text{FOR } \phi = 0)$$

$$= [104.9 \times 0.10] - \left[ \frac{(0.60 \times 42)}{0.99} \right] = 10.49 - \frac{25.71}{F_s}$$

$$\Sigma P_a = \frac{20.90 F_s - 6.26}{F_s + 0.73} + 49.01 - \frac{40.11}{F_s}$$

**FORCES  $P_b$**

WEDGE 4:  $\phi = 0, C = 0.60 \text{ KSF}, \gamma = 0.092 \text{ KCF}$  (SLIDING SURFACE de)

$$\beta_1 = 45^\circ$$

$$W = \frac{16.2}{2} \times 16.2 \times 0.092 = 12.07 \text{ KIPS}$$

$$P_{b1} = W \tan \beta + \frac{C \cdot L}{\cos \beta} \quad (\text{FOR } \phi = 0)$$

$$= 12.07 + \left[ \frac{0.60 \times 16.20}{F_s \times 0.707} \right] = 12.07 + \frac{19.44}{F_s}$$

$$\Sigma P_b = 12.07 + \frac{19.44}{F_s}$$

FIGURE 7 (continued)

Example of Stability Analysis of Translational Failure

SOLVE FOR  $F_S$ , FROM  $\Sigma P_a = \Sigma P_b$

$F_b$	$\Sigma P_a$	$\Sigma P_b$
1.0	17.4	31.5
1.1	21.7	29.7
1.2	25.3	28.3
1.3	28.5	27.0

$F_b = 1.27$

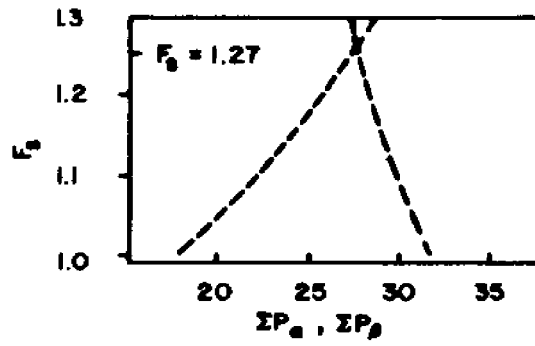

FIGURE 7 (continued)  
Example of Stability Analysis of Translational Failure

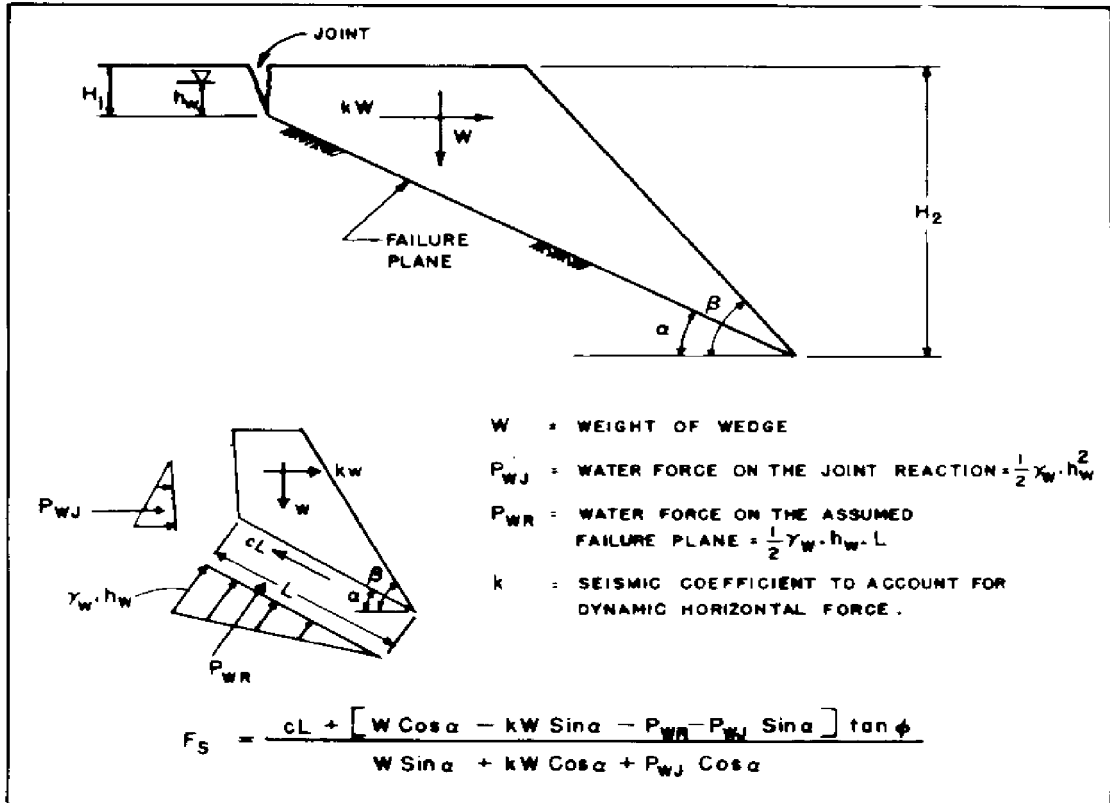

FIGURE 8  
Stability of Rock Slope

(1) Safety factor no less than 1.5 for permanent or sustained loading conditions.

(2) For foundations of structures, a safety factor no less than 2.0 is desirable to limit critical movements at foundation edge. See DM-7.2, Chapter 4 for detailed requirements for safety factors in bearing capacity analysis.

(3) For temporary loading conditions or where stability reaches a minimum during construction, safety factors may be reduced to 1.3 or 1.25 if controls are maintained on load application.

(4) For transient loads, such as earthquake, safety factors as low as 1.2 or 1.15 may be tolerated.

6. EARTHQUAKE LOADING. Earthquake effects can be introduced into the analysis by assigning a disturbing force on the sliding mass equal to  $kW$  where  $W$  is the weight of the sliding mass and  $k$  is the seismic coefficient. For the analyses of stability shown in Figure 9a,  $k+s, W$  is assumed to act parallel to the slope and through the center of mass of the sliding mass. Thus, for a factor of safety of 1.0:

$$Wb + k+s, Wh = FR$$

The factor of safety under an earthquake loading then becomes

$$F+Se, = \frac{FR}{Wb + k+s, Wh}$$

To determine the critical value of the seismic efficient ( $k+cs,$ ) which will reduce a given factor of safety for a stable static condition ( $F+So,$ ) to a factor of safety of 1.0 with an earthquake loading ( $F+Se, = 1.0$ ), use

$$k+cs, = \frac{b}{h} (F+So, - 1) = (F+So, -1) \sin [\theta]$$

If the seismic force is in the horizontal direction and denoting such force as  $k+ch, W$ , then  $k+ch, = (F+So, -1) \tan[\theta]$ .

For granular, free-draining material with plane sliding surface (Figure 9b):  $F+So, = \tan[\phi]/\tan[\theta]$ , and  $k+cs, = (F+So, -1)\sin[\theta]$ .

Based on several numerical experiments reported in Reference 7, Critical Acceleration Versus Static Factor of Safety in Stability Analysis of Earth Dams and Embankments, by Sarma and Bhave,  $k+ch,$  may be conservatively represented as  $k+ch,$  [approximately]  $(F+So, -1)0.25$ .

The downslope movement  $U$  may be conservatively predicted based on Reference 8, Effect of Earthquakes on Dams and Embankments, by Newmark as:

$$U = \frac{V. 2-}{2g k+cs,} [multiplied by] \frac{A}{k+cs,}$$

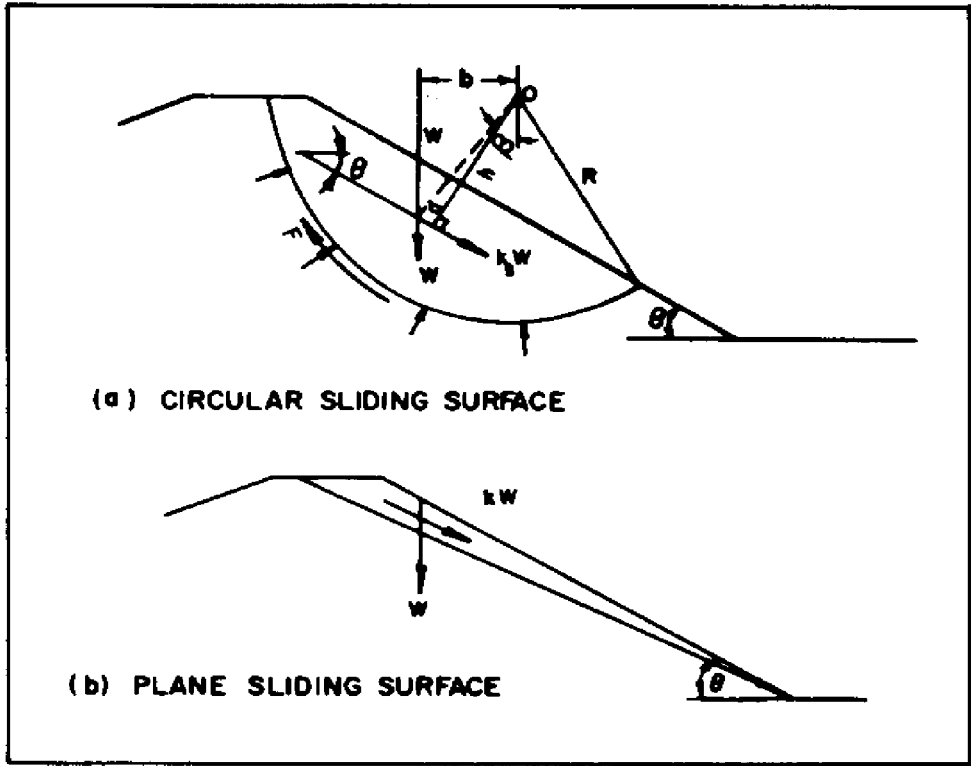

FIGURE 9  
 Earthquake Loading on Slopes

where

A = a peak ground acceleration, g's

g = a acceleration of gravity

V = peak ground velocity

The above equations are based on several simplifying assumptions: (a) failure occurs along well defined slip surface, (b) the sliding mass behaves as a rigid body; (c) soils are not sensitive and would not collapse at small deformation; and (d) there is no reduction in soil strength due to ground shaking.

#### Section 4. EFFECTS OF SOIL PARAMETERS AND GROUNDWATER ON STABILITY

1. INTRODUCTION. The choice of soil parameters and the methods of analyses are dictated by the types of materials encountered, the anticipated groundwater conditions, the time frame of construction, and climatic conditions. Soil strength parameters are selected either on the basis of total stress, ignoring the effect of the pore water pressure, or on the basis of effective stress where the analysis of the slope requires that the pore water pressures be treated separately.

2. TOTAL VS. EFFECTIVE STRESS ANALYSIS. The choice between total stress and effective stress parameters is governed by the drainage conditions which occur within the sliding mass and along its boundaries. Drainage is dependent upon soil permeability, boundary conditions, and time.

a. Total Stress Analysis. Where effective drainage cannot occur during shear, use the undrained shear strength parameters such as vane shear, unconfined compression, and unconsolidated undrained (UU or Q) triaxial compression tests. Field vane shear and cone penetration tests may be used. Assume  $[\phi] = 0$ . Examples where a total stress analysis are applicable include:

(1) Analysis of cut slopes of normally consolidated or slightly preconsolidated clays. In this case little dissipation of pore water pressure occurs prior to critical stability conditions.

(2) Analysis of embankments on a soft clay stratum. This is a special case as differences in the stress-strain characteristics of the embankment and the foundation may lead to progressive failure. The undrained strength of both the foundation soil and the embankment soil should be reduced in accordance with the strength reduction factors R+E, and R+F, in Figure 10 (Reference 9, An Engineering Manual for Slope Stability Studies, by Duncan and Buchignani).

(3) Rapid drawdown of water level providing insufficient time for drainage. Use the undrained strength corresponding to the overburden condition within the structure prior to drawdown.



(4) End-of-construction condition for fills built of cohesive soils. Use the undrained strength of samples compacted to field density and at water content representative of the embankment.

b. Effective Stress Analysis. The effective shear strength parameters ( $c'$ ,  $[\phi]'$ ) should be used for the following cases:

(1) Long-term stability of clay fills. Use steady state seepage pressures where applicable.

(2) Short-term or end-of-construction condition for fills built of free draining sand and gravel. Friction angle is usually approximated by correlation for this case. See Chapter 1.

(3) Rapid drawdown condition of slopes in pervious, relatively incompressible, coarse-grained soils. Use pore pressures corresponding to new lower water level with steady state flow.

(4) Long-term stability of cuts in saturated clays. Use steady state seepage pressures where applicable.

(5) Cases of partial dissipation of pore pressure in the field. Here, pore water pressures must be measured by piezometers or estimated from consolidation data.

3. EFFECT OF GROUNDWATER AND EXCESS PORE PRESSURE. Subsurface water movement and associated seepage pressures are the most frequent cause of slope instability. See Table 1 for illustrations of the effects of water on slope stability.

a. Seepage Pressures. Subsurface water seeping toward the face or toe of a slope produces destabilizing forces which can be evaluated by flow net construction. The piezometric heads which occur along the assumed failure surface produce outward forces which must be considered in the stability analysis. See Table 3 and the example of Figure 1.

b. Construction Pore Pressures. When compressible fill materials are used in embankment construction, excess pore pressure may develop and must be considered in the stability analysis. Normally, field piezometric measurements are required to evaluate this condition.

c. Excess Pore Pressures in Embankment Foundations. Where embankments are constructed over compressible soils, the foundation pore pressures must be considered in the stability analysis. See top panel of Table 3.

d. Artesian Pressures. Artesian pressures beneath slopes can have serious effects on the stability. Should such pressures be found to exist, they must be used to determine effective stresses and unit weights, and the slope and foundation stability should be evaluated by effective stress methods.



TABLE 3  
 Pore Pressure Conditions for Stability Analysis Homogeneous Embankment

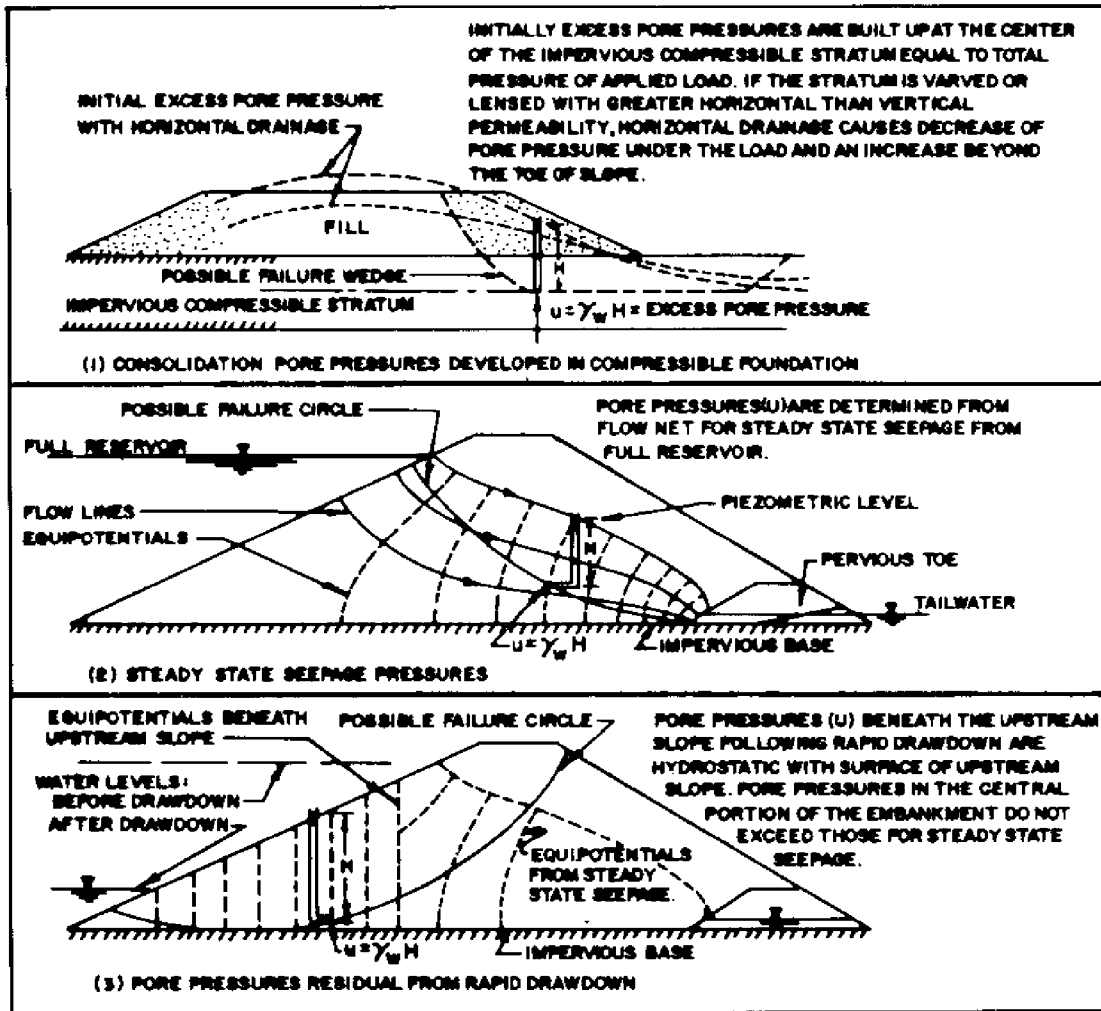

#### 4. STABILITY PROBLEMS IN SPECIAL MATERIALS

a. Controlling Factors. See Table 1, DM-7.2, Chapter 1, for primary factors controlling slope stability in some special problem soils.

b. Strength Parameters.

(1) Overconsolidated, Fissured Clays and Clayshales. See Table 2. Cuts in these materials cause opening of fissures and fractures with consequent softening and strength loss.

(a) Analysis of Cut Slopes. For long-term stability of cut slopes use residual strength parameters  $c' + r$ , and  $[\phi] + r$ , from drained tests. See Chapter 3. The most reliable strength information for fissured clays is frequently obtained by back figuring the strength from local failures.

(b) Old Slide Masses. Movements in old slide masses frequently occur on relatively flat slopes because of gradual creep at depth. Exploration may show the failure mass to be stiff or hard; but a narrow failure plane of low strength with slickensides or fractures may be undetected. In such locations avoid construction which involves regrading or groundwater rise that may upset a delicate equilibrium.

(2) Saturated Granular Soils in Seismic Areas. Ground shaking may result in liquefaction and strength reduction of certain saturated granular soils. Empirical methods are available for estimating the liquefaction potential. See DM-7.3, Chapter 1 for guidance. Methods of stabilization for such soils are discussed in DM-7.3, Chapter 2.

(3) Loess and Other Collapsible soils. Collapse of the structure of these soils can cause a reduction of cohesion and a rise in pore pressure.

Evaluate the saturation effects with unconsolidated undrained tests, saturating samples under low chamber pressure prior to shear. See Chapter 1 for evaluating collapse potential.

(4) Talus. For talus slopes composed of friable material,  $[\phi]$  may range from 20deg. to 25deg. If consisting of debris derived from slate or shale,  $[\phi]$  may range from 20deg. to 29deg., limestone about 32deg., gneiss 34deg., granite 35deg. to 40deg. These are crude estimates of friction angles and should be supplemented by analysis of existing talus slopes in the area.

#### Section 5. SLOPE STABILIZATION

1. METHODS. See Table 4, for a summary of slope stabilization methods. A description of some of these follows:

a. Regrading Profile. Flattening and/or benching the slope, or adding material at the toe, as with the construction of an earth berm, will increase the stability. Analyze by procedures above to determine most effective regrading.

TABLE 4  
Methods of Stabilizing Excavation Slopes





Scheme	Applicable Methods	Comments
<p>1. Changing Geometry</p> <p>EXCAVATION</p> 	<ol style="list-style-type: none"> <li>1. Reduce slope height by excavation at top of slope.</li> <li>2. Flatten the slope angle.</li> <li>3. Excavate a bench in upper part of slope.</li> </ol>	<ol style="list-style-type: none"> <li>1. Area has to be accessible to construction equipment. Disposal site needed for excavated soil. Drainage sometimes incorporated in this method.</li> </ol>
<p>2. Earth Berm Fill</p> 	<ol style="list-style-type: none"> <li>1. Compacted earth or rock berm placed at and beyond the toe. Drainage may be provided behind berm.</li> </ol>	<ol style="list-style-type: none"> <li>1. Sufficient width and thickness of berm required so failure will not occur below or through berm.</li> </ol>
<p>3. Retaining Structures</p> <p>RETAINING STRUCTURES</p> 	<ol style="list-style-type: none"> <li>1. Retaining wall - crib or cantilever type.</li> <li>2. Drilled, cast-in-place vertical piles, founded well below bottom of slide plane. Generally 18 to 36 inches in diameter and 4- to 8-foot spacing. Larger diameter piles at closer spacing may be required in some cases to mitigate failures of cuts in highly fissured clays.</li> </ol>	<ol style="list-style-type: none"> <li>1. Usually expensive. Cantilever walls might have to be tied back.</li> <li>2. Spacing should be such that soil can arch between piles. Grade beam can be used to tie piles together. Very large diameter (6 feet <math>\pm</math>) piles have been used for deep slides.</li> </ol>

TABLE 4 (continued)  
Methods of Stabilizing Excavation Slopes

Scheme	Applicable Methods	Comments
  	<p>3. Drilled, cast-in-place vertical piles tied back with battered piles or a deadman. Piles founded well below slide plane. Generally, 12 to 30 inches in diameter and at 4- to 8-foot spacing.</p> <p>4. Earth and rock anchors and rock bolts.</p> <p>5. Reinforced earth.</p>	<p>3. Space close enough so soil will arch between piles. Piles can be tied together with grade beam.</p> <p>4. Can be used for high slopes, and in very restricted areas. Conservative design should be used, especially for permanent support. Use may be essential for slopes in rocks where joints dip toward excavation, and such joints daylight in the slope.</p> <p>5. Usually expensive.</p>
<p>4. Other Methods</p>	<p>See Table 7, DM-7.2, Chapter 1</p>	

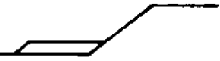
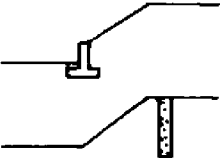
b. Seepage and Groundwater Control. Surface control of drainage decreases infiltration to potential slide area. Lowering of groundwater increases effective stresses and eliminates softening of fine-grained soils at fissures. Details on seepage and groundwater control are found in Chapter 6.

c. Retaining Structures.

(1) Application. Walls or large diameter piling can be used to stabilize slides of relatively small dimension in the direction of movement or to retain steep toe slopes so that failure will not extend back into a larger mass.

(2) Analysis. Retaining structures are frequently misused where active forces on wall are computed from a failure wedge comprising only a small percentage of the total weight of the sliding mass. Such failures may pass entirely beneath the wall, or the driving forces may be large enough to shear through the retaining structure. Stability analysis should evaluate a possible increase of pressures applied to wall by an active wedge extending far back into failing mass (see Figure 4, DM-7.2, Chapter 3), and possible failure on sliding surface at any level beneath the base of the retaining structure.

(3) Piles or Caissons. To be effective, the piles should extend sufficiently below the failure surface to develop the necessary lateral resistance. Figure 11 shows how the effect of the piles is considered in calculating the factor of safety. The distribution of pressure along the pile can be computed from charts shown in Figure 12. This assumes full mobilization of soil shear strength along the failure surface and should be used only when the safety factor without the piles is less than 1.4. This criteria is based on results of analysis presented in Reference 10, Forces Induced in Piles by Unsymmetrical Surcharges on the Soil Around the Pile, by DeBeer and Wallays.

See Figure 13 for example computations. Note the computations shown are for only one of the many possible slip surfaces.

d. Other Methods.

(1) Other potential procedures for stabilizing slopes include grouting, freezing, electro osmosis, vacuum pumping, and diaphragm walls. See Table 7 of DM-7.2, Chapter 1 for further guidance on these methods.

## Section 6. SLOPE PROTECTION

1. SLOPE EROSION. Slopes which are susceptible to erosion by wind and rain-fall should be protected. Protection is also required for slopes subjected to wave action as in the upstream slope of a dam, or the river and canal banks along navigational channels. In some cases, provision must be made against burrowing animals.

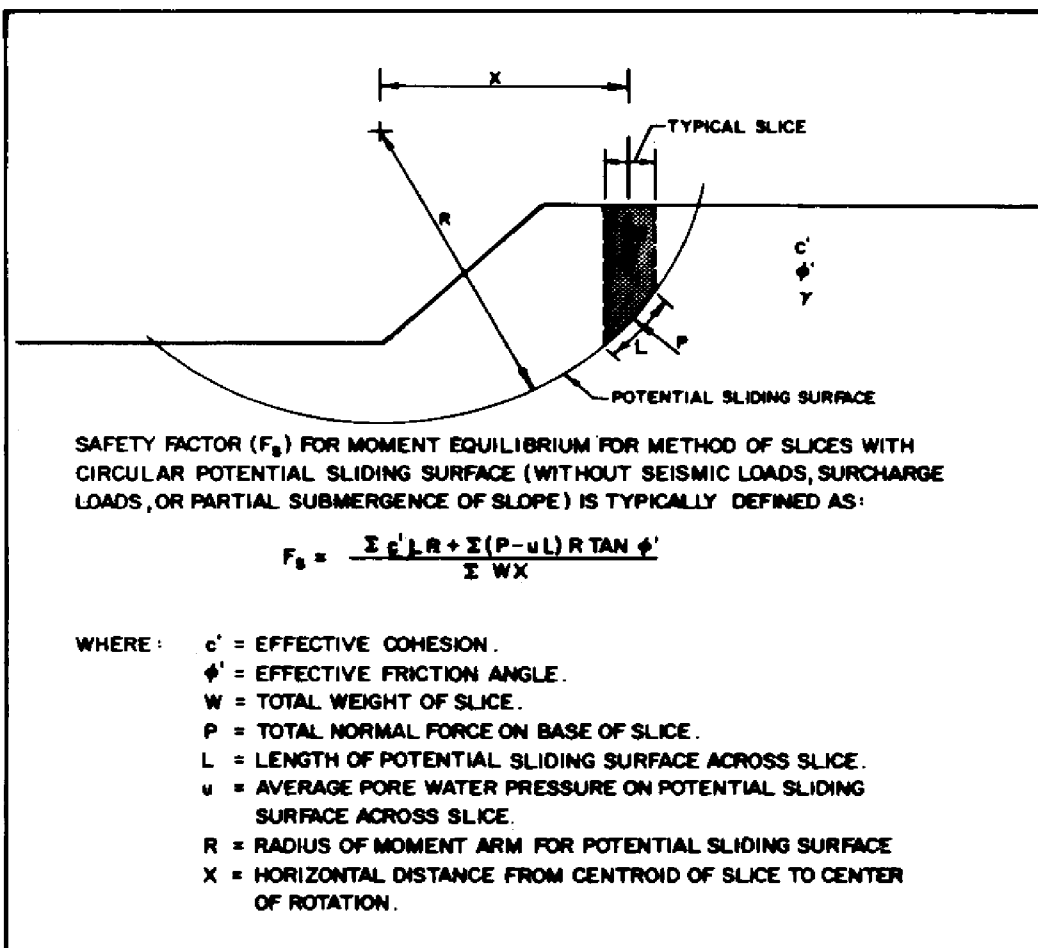
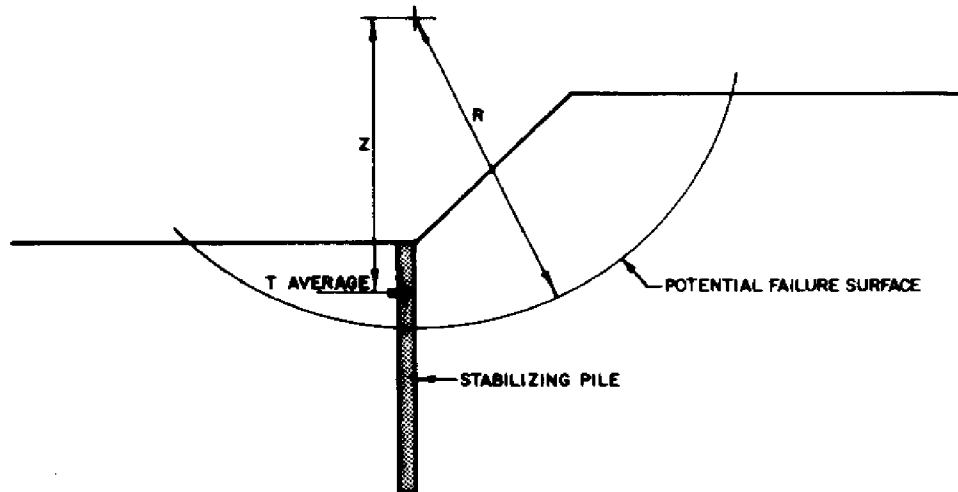

FIGURE 11  
Influence of Stabilizing Pile on Safety Factor



SAFETY FACTOR FOR MOMENT EQUILIBRIUM CONSIDERING THE SAME FORCES AS ABOVE PLUS THE EFFECT OF THE STABILIZING PILE IS EXPRESSED AS:

$$F_s = \frac{\Sigma c'LR + \Sigma (P-u)R \tan \phi' + TZ}{\Sigma WX}$$

WHERE: T = AVERAGE TOTAL THRUST (PER LIN. FT. HORIZ.) RESISTING SOIL MOVEMENT.

Z = DISTANCE FROM CENTROID OF RESISTING PRESSURE (THRUST) TO CENTER OF ROTATION.

FIGURE 11 (continued)  
Influence of Stabilizing Pile on Safety Factor

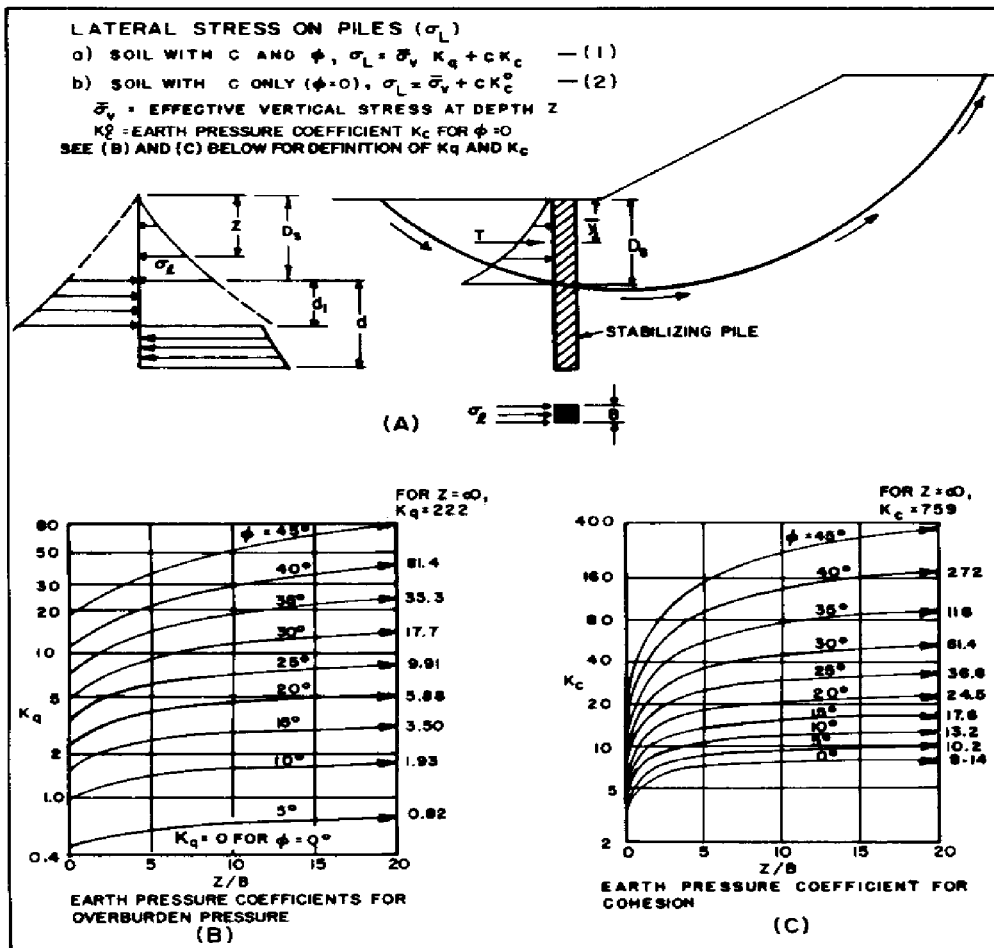

FIGURE 12  
Pile Stabilized Slope



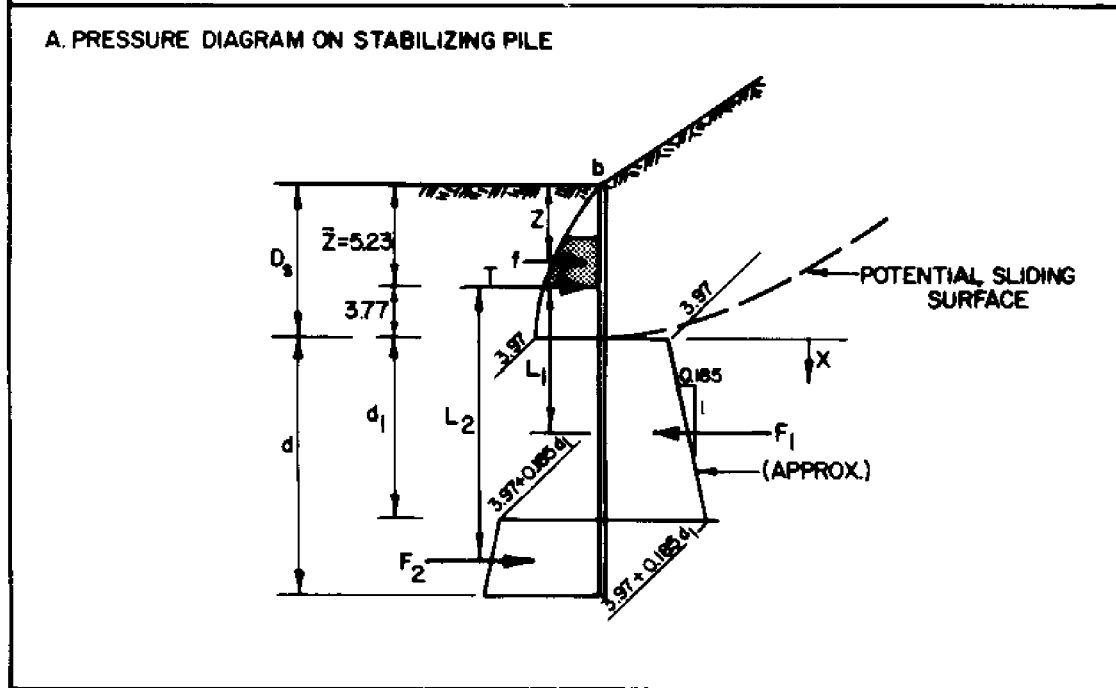
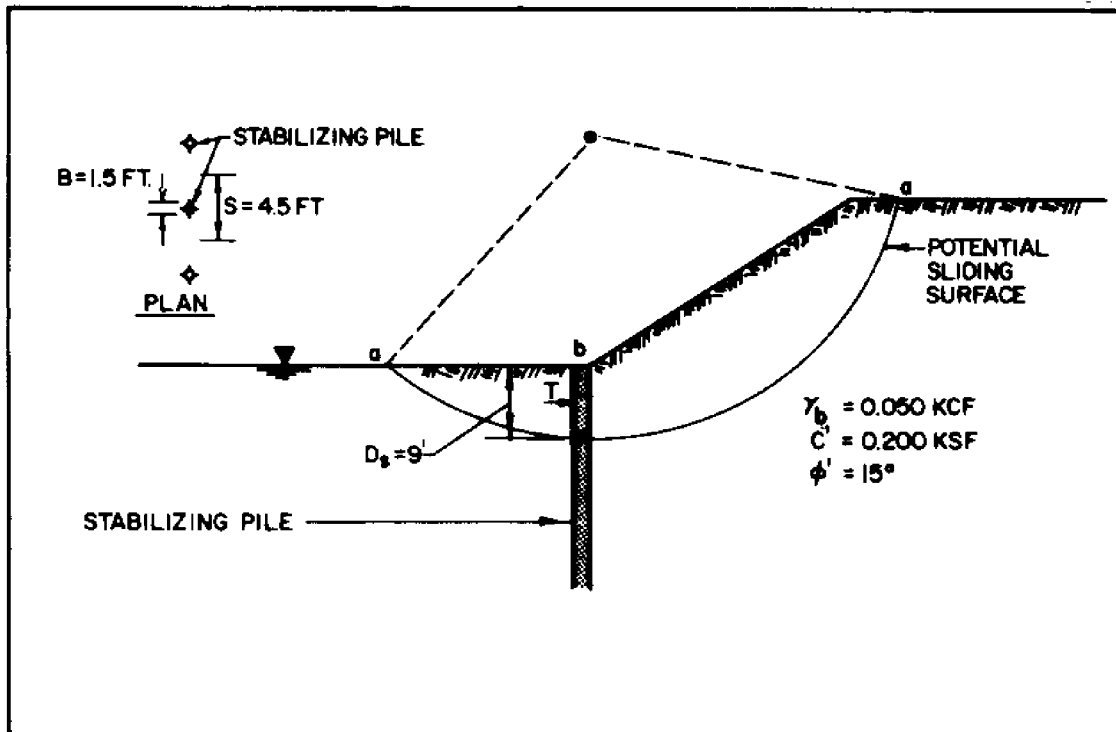

FIGURE 13  
 Example Calculation - Pile Stabilized Slopes

- B. For trial slip surface a-a compute lateral resistance, generated by presence of pile if factor of safety without piles is less than 1.4. Compute pressures using Figure 12.

$$\sigma_L = \bar{\sigma}_V K_q + cK_c \quad \text{SEE FIGURE 12 FOR DEFINITIONS}$$

Depth Below Top of Pile Z (ft)	Z/B	$K_q$	$K_c$	Vertical Effective Stress $\bar{\sigma}_V$ (kips/ft <sup>2</sup> )	Lateral Resistance to Soil Movement $\sigma_L$ KSF
0	0	1.5	4.0	0	0.8
3	2	2.1	10.8	0.15	2.48
6	4	2.4	12.8	0.30	3.28
9	6	2.6	14.0	0.45	3.97

- C. Compute centroid of lateral resistance (i.e., location of force T)

Depth Range	Resultant Resistance (f)		Z	fZ
	Over Depth Range			
0-3	$3 \left( \frac{0.8 + 2.48}{2} \right) B = 4.92B$		1.5	7.38B
3-6	8.64B		4.5	38.88B
6-9	10.87B		7.5	81.53B
	$\Sigma T = 24.43B$			127.79B

$$\bar{Z} = 127.79/24.43 = 5.23 \text{ ft}$$

- D. Lateral resistance per linear foot of slope

$$T_1 = \Sigma T/S = 24.43 \times 1.5/4.5 = 8.14k$$

Note that T accounts for three dimensional condition and need not be corrected.

- E. Use  $T_1$  in Step D and  $\bar{Z}$  in Step C to compute additional stabilizing moment for evaluating safety factor including effect of piles (see Figure 11).

FIGURE 13 (continued)  
Example Calculation - Pile Stabilized Slopes

```

+))))))))))))))))))))))))))))))))))))))))))))))))))))))))))))))))))))))))))))))))))))))))))
*F. Compute +L, at depth corresponding to Z/B = 20 (Z = 30) in order to
* compute average Increase of positive resistance with depth:
*
*
*           K+q, = 3.1, K+c, = 16
*
*           [sigma]+L, = 3.1 x 30 x 0.05 + 16 x 0.2 = 7.85 KSF
*
* Average increase in lateral resistance below D+s, :
*
*           [sigma]+L+avg,, = (7.85 - 3.97)/(30 - 9) = 0.185 KSF/ft
*
* Assume that the direction of lateral resistance changes at depth d+1,
* beneath failure surface, then:
*
*G. Calculate depth of penetration d by solving the following equations
* and increase d by 30% for safety:
*
*           T + F+2, - F+1, = 0           (1)
*
*           F+1, L+1, = F+2, L+2,       (2)
*
* Compute forces per unit pile width:
*
*           T = 24.43.k-
*
*           F+1, = 3.97d+1, + 0.092d+1,.2-
*
*           F+2, = (3.97 + 0.185d+1,)(d-d+1,) + 0.092 (d-d+1,).2-
*
*                   = 0.092d.2- + 3.97d - 3.97+d,.1- - 0.092d+1,.2-
*
*H. Use Eq (1) in Step G to calculate d+1, for given values of d.
*
*           24.43 + 0.092d.2- + 3.97d - 7.94d+1, - 0.185d+1,.2- = 0
*
*                   24.43 + 0.092d.2- + 3.97d
*           d+1,.2- + 42.9d+1, - )))))))))))))))))))))))))))) = 0
*                   0.185
*
*           Let d = 15.8', then d+1, = 11.0'
*
*           From Eq (2) Step G (consider each section of pressure diagram broken
*           down as a rectangle and triangle).
*
.))))))))))))))))))))))))))))))))))))))))))))))))))))))))))))))))))))))))))))))))))))))))))

```

FIGURE 13 (continued)  
Example Calculation - Pile Stabilized Slopes

$$F_1 L_1 = \left[ 3.97 \times 11.0 \times \left( 3.77 + \frac{11.0}{2} \right) \right] + \left[ \frac{0.185}{2} \times 11.0^2 \times \left( 3.77 + \frac{2 \times 11.0}{3} \right) \right]$$

$$= 529.1 \text{ FT-KPS}$$

$$d - d_1 = 4.8$$

$$F_2 L_2 = \left[ (3.97 + 0.185 \times 11.0) \times 4.8 \times \left( 3.77 + 11.0 + \frac{4.8}{2} \right) \right]$$

$$+ \left[ \frac{0.185}{2} \times 4.8^2 \times \left( 3.77 + 11.0 + \frac{2 \times 4.8}{3} \right) \right]$$

$$= 533.2$$

$$F_1 L_1 - F_2 L_2 = -4.1$$

$$d \approx 15.8' \text{ O.K.}$$

#### I. Design

Increase  $d$  by 30% to obtain the practical driving depth

$$d = 15.8 \times 1.3 = 20.5'$$

LOCATE POINT OF ZERO SHEAR

$$24.43 = 3.97 X + 0.092 X^2$$

$$X^2 + 43.15 X - 265.54 = 0$$

$$X = \frac{-43.15 \pm \sqrt{43.15^2 + 4 \times 265.54}}{2}$$

$$= 5.46'$$

COMPUTE MAXIMUM BENDING ON PILE ( $B=1.5'$ )

$$M_{\max} = \left[ 24.43 X (3.77 + 5.46) - \left( \frac{3.97 \times 5.46^2}{2} + \frac{0.185 \times 5.46^3}{2 \times 3} \right) \right] \times 1.5$$

$$= 241.9 \text{ Kp-FT}$$

CHECK PILE SECTION VS  $M_{\max}$

#### NOTES:

- Higher embedment may be required to minimize slope movements.
- Use residual shear strength parameters if appropriate.
- Analysis applicable for safety factor  $\leq 1.4$  without piles. Soil movement assumed to be large enough to justify assumption on rupture conditions.

FIGURE 13 (continued)  
Example Calculation - Pile Stabilized Slopes

2. TYPES OF PROTECTION AVAILABLE. The usual protection against erosion by wind and rainfall is a layer of rock, cobbles, or sod. Protection from wave action may be provided by rock riprap (either dry dumped or hand placed), concrete pavement, precast concrete blocks, soil-cement, fabric, and wood. See Table 8, Chapter 6 for additional guidance.

a. Stone Cover. A rock or cobbles cover of 12" thickness is sufficient to protect against wind and rain.

b. Sod. Grasses suitable for a given locality should be selected with provision for fertilizing and uniform watering.

c. Dumped Rock Riprap. This provides the best protection against wave action. It consists of rock fragments dumped on a properly graded filter. Rock used should be hard, dense, and durable against weathering and also heavy enough to resist displacement by wave action. See Table 5 for design guidelines. For additional design criteria see Figure 14, Chapter 6.

d. Hand-placed Riprap. Riprap is carefully laid with minimum amount of voids and a relatively smooth top surface. Thickness should be one-half of the dumped rock riprap but not less than 12". A filter blanket must be provided and enough openings should be left in the riprap facing to permit easy flow of water into or out of the riprap.

e. Concrete Paving. As a successful protection against wave action concrete paving should be monolithic and of high durability. Underlying materials should be pervious to prevent development of uplift water pressure. Use a minimum thickness of 6".

When monolithic construction is not possible, keep the joints to a minimum and sealed. Reinforce the slab at mid depth in both directions with continuous reinforcement through the construction joints. Use steel area in each direction equal to 0.5% of the concrete area.

f. Gabions. Slopes can be protected by gabions. Use of these is discussed in DM-7.02, Chapter 3.

TABLE 5  
Thickness and Gradation Limits of Dumped Riprap

```

+)))))))))))))))))))))))))))))))))))))))))))))))))))))))))))))))))))))))))))))))))))))))))))
* +)))))))0))))))))0))))))))))))))))))))))))))))))))))))))))))))))))))))))))))))))))))))))))))
* * * * * Gradation, percentage of stones of * *
* * * * * various weights, pounds[1] * *
* * * * * /))))))))0))))))))0))))))))0))))))))0))))))))1 *
* * * * * * 40 to 50 * 50 to 60 * 0 to 10 * *
* * * * * Nominal * * percent * percent * percent * *
* * * * * thickness * Maximum * greater * from - to * less * *
* * * * * inches * Size * than * * * * * than[2] * *
* * Slope * * * * * * * * * *
* /))))))3))))))))3))))))))3))))))))3))))))))3))))))))3))))))))1 *
* * 3:1 * 30 * 2,500 * 1,250 * 75 - 1,250 * 75 * *
* * * * * * * * * * * * * * * *
* * 2:1 * 36 * 4,500 * 2,250 * 100 - 2,250 * 100 * *
* .))))))2))))))))2))))))))2))))))))2))))))))2))))))))2))))))))- *
* [1] Sand and rock dust shall be less than 5 percent, by weight, of the total *
* riprap material. *
* * * * *
* [2] The percentage of this size material shall not exceed an amount which will*
* fill the voids in larger rock. *
.))))))))))))))))))))))))))))))))))))))))))))))))))))))))))))))))))))))))))))))))))))))))-

```

#### REFERENCES

1. Transportation Research Board, Landslide Analysis and Control, Special Report 176, 1978.
2. Lambe, T. W. and Whitman, R. V., Soil Mechanics, John Wiley & Sons, Inc., 1969.
3. Fang, H. Y., Stability of Earth Slopes, Foundation Engineering Handbook, Winterkorn and Fang, ed., Chapter 10, Van Nostrand Reinhold Co., New York, 1975.
4. Janbu, N., Stability Analysis of Slopes with Dimensionless Parameters, Harvard Soil Mechanics Series No. 46, Harvard University, Cambridge, MA.
5. Jakobsen, R. E., The Design of Embankments on Soft Clays, Geotechnique, 1948.
6. Von Thun, J. L., The Practical and Realistic Solution of Rock Slope Stability Problems, Design Methods in Rock Mechanics, Proceedings of Sixteenth Symposium on Rock Mechanics, ASCE, September 22-24, 1977.
7. Sarma, S. K. and Bhave, M. V., Critical Acceleration Versus Static Factor of Safety in Stability Analysis of Earth Dams and Embankments, Geotechnique, Vol. 24, No. 4, 1974.
8. Newmark, N. M., Effects of Earthquakes on Dams and Embankments, Geotechnique, Vol. 15, No. 2, 1965.
9. Duncan, J. M. and Buchignani, A. L., An Engineering Manual for Slope Stability Studies, Department of Civil Engineering, Institute of Transportation and Traffic Engineering, University of California, Berkeley, March, 1975.
10. DeBeer, E. E. and Wallays, M., Forces Induced in Piles by Unsymmetrical Surcharges on the Soil Around the Pile, Proceedings of Fifth European Conference Soil Mechanics and Foundation Engineering, Madrid, Volume 1, p. 335, 1972.

## BIBLIOGRAPHY

- American-Society of Photogrammetry, Manual of Photo Interpretation, Washington, D. C., 1960.
- ASTM STP 447, Determination of the In Situ Modulus of Deformation of Rock, Symposium, Denver, February 2-7, 1969.
- Ash, J. L. et al., Improved Subsurface Investigation for Highway Tunnel Design and Construction, Vol. 1, Subsurface Investigation System Planning, FHWA, May 1974.
- Burmister, D. M., Physical, Stress-Strain, and Strength Responses of Granular Soils, ASTM Spec. Pub. No. 322, ASTM, Philadelphia, pp 67-97, 1962.
- Cedergren, H., Seepage, Drainage and Flow Nets, McGraw-Hill Book Co., Inc., New York, 1967.
- Chen, W. F., Limit Analysis and Soil Plasticity, Elsevier Scientific Publishing Co., New York, 1975.
- Dallaire, G., Controlling Erosion and Sedimentation at Construction Sites, Civil Engineering, ASCE, pp 73-77, 1976.
- Foster, C. R. and Ahlvin, P. G., Stresses and Deflections Induced by Uniform Circular Load, Highway Research Board Proceedings, Highway Research Board, Washington, D. C., 1954.
- Harr, M. E., Groundwater and Seepage, McGraw-Hill Book Co., Inc., New York, 1962.
- Hoek, E. and Bray, J. W., Rock Slope Engineering, 2nd Edition, The Institute of Mining and Metallurgy, London, 1977.
- Menard, L. F., Interpretation and Application of Pressuremeter Test Results, Soils-Soils, Vol. 26, pp 1-43, 1975.
- Mooney, H. M., Handbook of Engineering Seismology, Bison Instruments, Inc., Minneapolis, MN., 1973.
- Noorany, I. and Gizienski, S. F., Engineering Properties of Submarine Soils, A State-of-the-Art Review, Journal of Soil Mechanics and Foundation Division, ASCE, Vol. 96, No. SM5, 1970.
- Peck, R. B., Stability of Natural Slopes, Journal of Soil Mechanics and Foundation Division, ASCE, Vol. 93, No. SM4, 1967.
- Poulos, N. C. and Davis, E. H., Elastic Solutions for Soil and Rock Mechanics, John Wiley & Sons, Inc., New York, 1974.



Seed, H. B., A Method for Earthquake Resistant Design of Earth Dams, Journal of the Soil Mechanics and Foundation Division, ASCE, Vol. 92, No. SM1, 1966.

Seed, H. B., Makdisi, F. I. and De Alba, P., Performance of Earthdams During Earthquakes, Journal of the Geotechnical Engineering Division, ASCE, Vol. 104, No. GT7, 1978.

Skempton, A. W., and Hutchinson, J., Stability of Natural Slopes and Embankment Foundations, State-of-the-Art Paper, Proceedings, Seventh International Conference Soil Mechanics Foundation Engineering, Mexico, pp 291-340, 1969.

Soil Conservation Service, USDA, A Comprehensive System, 7th Approximation, U.S. Government Printing Office, Washington, D. C. p. 265, 1960, and supplement 1967, 1968, and 1970.

Sowers, C. F., Shallow Foundations, Foundation Engineering, Leonards, Editor, McGraw-Hill Book Co., Inc., New York, Chapter 6, 1962.

Stagg, K. G., Insitu Tests on the Rock Mass, Rock Mechanics in Engineering Practice, Stagg and Zienkiewicz, Editors, John Wiley and Sons, New York, Chapter 5, 1969.

Terzaghi, K., Varieties of Submarine Slope Failures, Proceedings, Eighth Texas Conference on Soil Mechanics and Foundation Engineering, 1956.

Terzaghi, K., Stability of Steep Slopes on Hard, Unweathered Rock, Geotechnique, Vol. 12, No. 4, 1962.

Transportation Research Record 581: Innovations in Subsurface Exploration of Soils, Transportation Research Board, 1976.

Underwood, L. B., Exploration and Geologic Prediction for Underground Works, Subsurface Exploration for Underground Excavation and Heavy Construction, ASCE, New York, pp 65-83, 1974.

U.S.G.S., Earth Science Information in Land-Use Planning -Guidelines for Earth Scientists and Planners, Geological Survey Circular No. 721, U. S. Geological Survey, Fairfax, VA., 1976.

APPENDIX A  
Listing of Computer Programs

Subject	Program	Description	Availability
Field Exploration, Testing and Instrumentation (Chapter 2)	SOILS 1	Geotechnical data file for Navy facilities.	Naval Facilities Engineering Command HQ, Alexandria, VA
	SOILS 2	Retrieval of data from SOILS 1.	"
	SOILS 3	Modification or addition to existing data base file.	"
Distribution of Stresses (Chapter 4) and Settlement Analyses (Chapter 5)	HSPACE GESA Catalog No. E01-0002-00030	Stresses and displacements in an elastic half-space with interior loads.	Geotechnical Engineering Software Activity University of Colorado Boulder, CO 80309 (GESA)
	SAS3D GESA Catalog No. E01-0003-00042	Stresses and displacements in an isotropic elastic half-space due to rectangular surface loads.	"
	CANDE	Analysis for design of buried conduits. Solution methods include closed form elastic methods and a general finite element solution.	Federal Highway Administration, Office of Research and Development Washington, D.C.
	ICES SEPOL 1	Analysis of stress distribution, magnitude and rate of settlement for horizontally layered soil, and multiple complex surface loads. Stresses calculated assuming homogeneous elastic half-space.	ICES Users Group, Inc. ICES Distribution Agency P.O. Box 142, MIT Branch Cambridge, MA 02139

APPENDIX A (continued)  
 Listing of Computer Programs

Subject	Program	Description	Availability
Distribution of Stress (Chapter 4) and Settlement Analyses (Chapter 5)	FEECON	A finite element analysis for computing undrained deformation of soft clay foundations under granular embankments. Stresses calculated can be used to evaluate yield conditions and stability.	Massachusetts Institute of Technology (MIT) Cambridge, MA
	PROGRS GESA Catalog No. E02-0002-00014	One dimensional consolidation of multi-layered system using the finite difference method.	Geotechnical Engineering Software Activity
	CONS-2DFE	Finite element program for solving consolidation problem under plane strain (or axisymmetric) conditions.	Virginia Polytechnic Institute and State University, Blacksburg, VA 24061
	SDRAIN GESA Catalog No. E02-0003-00017	One dimensional settlement analysis and excess pore pressure due to embankments on layered soils using sand drains.	Geotechnical Engineering Software Activity
	SSTIN-2DFE	Finite element program for two dimensional (plane strain or axisymmetric) soil structure interaction problems.	Virginia Polytechnic Institute and State University
Seepage and Drainage (Chapter 6)	FEDAR GESA Catalog No. E07-NQQA-0050	Finite element program for analysis of steady confined and unconfined seepage.	Geotechnical Engineering Software Activity or Massachusetts Institute of Technology

## GLOSSARY

Activity of Clay - The ratio of plasticity index to percent by weight of the total sample that is smaller than 0.002 mm in grain size. This property is correlated with the type of clay material.

Anisotropic Soil - A soil mass having different properties in different directions at any given point referring primarily to stress-strain or permeability characteristics.

Capillary Stresses - Pore water pressures less than atmospheric values produced by surface tension of pore water acting on the meniscus formed in void spaces between soil particles.

Clay Size Fraction - That portion of the soil which is finer than 0.002 mm, not a positive measure of the plasticity of the material or its characteristics as a clay.

Desiccation - The process of shrinkage or consolidation of the fine-grained soil produced by increase of effective stresses in the grain skeleton accompanying the development of capillary stresses in the pore water.

Effective Stress - The net stress across points of contact of soil particles, generally considered as equivalent to the total stress minus the pore water pressure.

Equivalent Fluid Pressure - Horizontal pressures of soil, or soil and water, in combination, which increase linearly with depth and are equivalent to those that would be produced by a heavy fluid of a selected unit weight.

Excess Pore Pressures - That increment of pore water pressures greater than hydro-static values, produced by consolidation stresses in compressible materials or by shear strain.

Exit Gradient - The hydraulic gradient (difference in piezometric levels at two points divided by the distance between them) near to an exposed surface through which seepage is moving.

Flow Slide - Shear failure in which a soil mass moves over a relatively long distance in a fluidlike manner, occurring rapidly on flat slopes in loose, saturated, uniform sands, or in highly sensitive clays.

Hydrostatic Pore Pressures - Pore water pressures or groundwater pressures exerted under conditions of no flow where the magnitude of pore pressures increase linearly with depth below the ground surface.

Isotropic Soil - A soil mass having essentially the same properties in all directions at any given point, referring directions at any given point, referring primarily to stress-strain or permeability characteristics.

Normal Consolidation - The condition that exists if a soil deposit has never been subjected to an effective stress greater than the existing overburden pressure and if the deposit is completely consolidated under the existing overburden pressure.

Overconsolidation - The condition that exists if a soil deposit has been subjected to an effective stress greater than the existing overburden pressure.

Piezometer - A device installed for measuring the pressure head of pore water at a specific point within the soil mass.

Piping - The movement of soil particles as the result of unbalanced seepage forces produced by percolating water, leading to the development of boils or erosion channels.

Plastic Equilibrium - The state of stress of a soil mass that has been loaded and deformed to such an extent that its ultimate shearing resistance is mobilized at one or more points.

Positive Cutoff - The provision of a line of tight sheeting or a barrier of impervious material extending downward to an essentially impervious lower boundary to intercept completely the path of subsurface seepage.

Primary Consolidation - The compression of the soil under load that occurs while excess pore pressures dissipate with time.

Rippability - The characteristic of dense and rocky soils that can be excavated without blasting after ripping with a rock rake or ripper.

Slickensides - Surfaces with a soil mass which have been smoothed and striated by shear movements on these surfaces.

Standard Penetration Resistance - The number of blows of a 140-pound hammer, falling 30 inches, required to advance a 2-inch O.D., split barrel sampler 12 inches through a soil mass.

Total Stress - At a given point in a soil mass the sum of the net stress across contact points of soil particles (effective stress) plus the pore water pressure at the point.

Underconsolidation - The condition that exists if a soil deposit is not fully consolidated under the existing overburden pressure and excess hydrostatic pore pressures exist within the material.

Varved Silt or Clay - A fine-grained glacial lake deposit with alternating thin layers of silt or fine sand and clay, formed by variations in sedimentation from winter to summer during the year.

SYMBOLS

Symbol	Designation
A	Cross-sectional area.
A+c, a+v, B,b	Activity of fine-grained soil. Coefficient of compressibility. Width in general; or narrow dimension of a foundation unit.
CBR	California Bearing Ratio.
C+c,	Compression index for virgin consolidation.
CD	Consolidated-drained shear test.
C+r,	Recompression index in reconsolidation.
C+s,	Swelling index.
CU	Consolidated-undrained shear test.
C+u,	Coefficient of uniformity of grain size curve.
C+z,	Coefficient of curvation of gradation curve.
C+[alpha], c	Coefficient of secondary compression. Cohesion intercept for Mohr's envelop of shear strength based on total stresses.
c'	Cohesion intercept for Mohr's envelope of shear strength based on effective stresses.
c+h,	Horizontal coefficient of consolidation.
c+v,	Vertical coefficient of consolidation.
D,d	Depth, diameter, or distance.
D+r,	Relative density.
D+10,	Effective grain size of soil sample; 10% by dry weight of sample is smaller than this grain size.
D+5, , D+60, D+85,	Grain size division of a soil sample, percent of dry weight smaller than this grain size is indicated by subscript.
E	Modulus of elasticity of structural material.
E+s,	Modulus of elasticity or "modulus of deformation" of soil.
e	Void ratio.
e+f,	Final void ratio reached in loading phase of consolidation test.
e+o,	Initial void ratio in consolidation test generally equal to natural void in situ.
e+r,	Void ratio existing at the start of rebound in a consolidation test.
F	Shape factor describing the characteristics of the flow field in underseepage analysis.
F+s,	Safety factor in stability or shear strength analysis.
G	Specific gravity of solid particles in soil sample, or shear modulus of soil.
H,h	In general, height or thickness. For

	analysis of time rate of consolidation, H is the maximum vertical dimension of the drainage path for pore water.
h+c,	Capillary head formed by surface tension in pore water.
H+t,	Depth of tension cracks or total thickness of consolidating stratum or depth used in computing loads on tunnels.
H+w,	Height of groundwater or of open water above a base level.
I	Influence value for vertical stress produced by superimposed load, equals ratio of stresses at a point in the foundation to intensity of applied load.

Symbol	Designation
i	Gradient of groundwater pressures in underseepage analysis.
K+A, K+p,	Coefficient of active earth pressures. Coefficient of passive earth pressures.
K+v,	Modulus of subgrade reaction for bearing plate or foundation of width b.
K+v*,	Modulus of subgrade reaction for 1 ft square bearing plate at ground surface.
k	Coefficient of permeability in general.
k+H,	Coefficient of permeability in horizontal direction.
k+m,	Mean coefficient of permeability of anisotropic subsoil.
ksf	Kips per sq ft pressure intensity.
ksi	Kips per sq in pressure intensity.
k+V,	Coefficient of permeability in vertical direction.
L, l	Length in general or longest dimension of foundation unit.
LI	Liquidity index.
LL	Liquid limit.
m+v,	Coefficient of volume compressibility in consolidation test.
n	Porosity of soil sample.
n+d,	Number of equipotential drops in flow net analysis of underseepage.
n+e,	Effective porosity, percent by volume of water drainable by gravity in total volume of soil sample.
n+f,	Number of flow paths in flow net analysis of underseepage.
OMC	Optimum moisture content of compacted soil.
P+A,	Resultant active earth force.
P+AH,	Component of resultant active force in horizontal direction.
pcf	Density in pounds per cubic foot.
P+c,	Preconsolidation stress.
P+h,	Resultant horizontal earth force.
P+o,	Existing effective overburden pressure acting at a specific height in the soil profile or on a soil sample.
PI	Plasticity index.
PL	Plastic limit.
P+P,	Resultant passive earth force.
P+PH,	Component of resultant passive earth force in horizontal direction.
P+v,	Resultant vertical earth force.
P+w,	Resultant force of water pressure.
p	Intensity of applied load.
q	Intensity of vertical load applied to foundation unit.
q+u,	Unconfined compressive strength of soil sample.
q+ult,	Ultimate bearing capacity that causes



R,r	shear failure of foundation unit. Radius of pile, caisson well or other right circular cylinder.
R+o,	Radius of influence of a well, distance from the well along a radial line to the point where initial groundwater level is unaltered.
r+e,	Effective radius of sand drain.
r+s,	Radius of smear zone surrounding sand drain.
r+w,	Actual radius of sand drain.
S	Percent saturation of soil mass.
SI	Shrinkage index.

Symbol	Designation
SL	Shrinkage limit.
S+t,	Sensitivity of soil, equals ratio of remolded to undisturbed shear strength.
s	Shear strength of soil for a specific stress or condition in situ, used instead of strength parameters c and $[\phi]$ .
T+o,	Time factor for time at end of construction in consolidation analysis for gradual loading.
T+v,	Time factor in consolidation analysis for instantaneous load application.
tsf	Tons per sq ft pressure intensity.
t,t+1, ,	Time intervals from start of loading to the points 1, 2, or n.
t+2, ,t+n,	Time required for a percent consolidation to be completed indicated by subscript
t+50, ,t+100,	
U	Resultant force of pore water or groundwater pressures acting on a specific surface within the subsoils.
U	Average degree of consolidation at any time.
u	Intensity of pore water pressure.
UU	Unconsolidated-undrained shear test.
V+a,	Volume of air or gas in a unit total volume of soil mass.
V+s,	Volume of solids in a unit total volume of soil mass.
V+v,	Volume of voids in a unit total volume of soil mass.
V+w,	Volume of water in a unit total volume of soil mass.
W+s,	Weight of solids in a soil mass or soil sample.
W+t,	Total weight of soil mass or soil sample.
W+w,	Weight of water in a soil mass or soil sample.
w	Moisture content of soil.
$[\gamma]$ +D,	Dry unit weight of soil
$[\gamma]$ +MAX,	Maximum dry unit weight of soil determined from moisture content dry unit weight curve.
$[\gamma]$ +SAT,	Saturated unit weight of soil.
$[\gamma]$ +SUB, , $[\gamma]$ +b,	Submerged (buoyant) unit weight of soil mass.
$[\gamma]$ +T,	Wet unit weight of soil above the groundwater table.
$[\gamma]$ +W,	Unit weight of water, varying from 62.4 pcf for fresh water to 64 pcf for sea water.
$[\epsilon]$	Unit strain in general.
$[\epsilon]$ +a,	Axial strain in triaxial shear test.
$[W-\Delta]e$	Change in void ratio corresponding to a change in effective stress,

[delta], [delta]+v, , [delta]+c,	[W-DELTA]p. Magnitude of settlement for various conditions.
[phi]	Angle of internal friction or "angle of shearing resistance," obtained from Mohr's failure envelope for shear strength.
[sigma]*	Total major principal stress.
[sigma]+3,	Total minor principal stress
)	
[sigma]*.	Effective major principal stress
)	
[sigma]+3,	Effective minor principal stress.
[sigma]+x, , [sigma]+y, , [sigma]+z,	Normal stresses in coordinate directions.
[tau]	Intensity of shear stress.
[tau]+MAX,	Intensity of maximum shear stress.
[upsilon]	Poisson's Ratio

INDEX

A

Anisotropic foundations.....7.1-176  
    See Stresses, Elastic,  
        Layered or Anisotropic  
Atterberg limits.....7.1-137  
    See Tests, laboratory,  
        Index Properties.

B

Bibliography.....7.1-B-1

C

Compaction tests.....7.1-153  
    In-place density.....7.1-109  
    Laboratory tests.....7.1-153  
Computer Programs, Listing of.....7.1-A-1

D

Distribution of stresses and  
    pressures.....7.1-162  
    See Stresses and pressures.  
Drainage analysis.....7.1-260  
    See Seepage and drainage.  
Dynamic Soil Properties.....7.1-151

E

Exploration and sampling.....7.1-49  
    Existing soil and geological  
        maps.....7.1-51  
    Previous investigations.....7.1-51  
        Evaluation.....7.1-51  
        Shipyards or waterfront  
            areas.....7.1-51  
    Geophysical methods.....7.1-59  
        Limitations.....7.1-65  
            Check borings.....7.1-65  
            Sources of error.....7.1-65  
        Utilization.....7.1-59  
            Advantages.....7.1-59  
            Applications.....7.1-59  
    Groundwater measurements.....7.1-93  
    Penetration Resistance  
        Tests.....7.1-85  
            Standard penetration.....7.1-85  
            Cone penetration test.....7.1-86  
    Program, exploration,  
        requirements.....7.1-65  
        Depths of test borings.....7.1-65  
            Check borings.....7.1-71  
            Types of strata.....7.1-65  
        Layout of test borings.....7.1-65  
            Final borings.....7.1-65  
            Preliminary borings.....7.1-65  
            Spacing requirements.....7.1-65

Procedures, detailed.....	7.1-73
Sample preservation.....	7.1-73
Sampling operation.....	7.1-63
Sampling program requirements.....	7.1-73
Representative dry samples.....	7.1-73
Undisturbed samples.....	7.1-73
Undisturbed samples, equipment for obtaining.....	7.1-73
Undisturbed samples, obtaining.....	7.1-73
Programs, exploration.....	7.1-49
Detailed exploration.....	7.1-51
Preliminary exploration.....	7.1-51
Reconnaissance.....	7.1-49
Remote Sensing Methods.....	7.1-51
Limitations.....	7.1-59
Sources.....	7.1-51
Coverage and aerial photographs.....	7.1-59
Services, photo interpretation.....	7.1-59
Utilization.....	7.1-51
Flight strips.....	7.1-59
Interpretation.....	7.1-59
Sampling devices.....	7.1-73
Thick-wall, spoon, auger, and core barrel samplers.....	7.1-73
Core barrel samples.....	7.1-80
Thin-wall tube samplers.....	7.1-73
Test borings.....	7.1-65
Procedures, specific.....	7.1-66
Selection of boring method.....	7.1-66
Types.....	7.1-66

Exploration and sampling (continued)

Test pits and trenches.....7.1-71  
    Hand-cut samples.....7.1-80  
    Machine excavation.....7.1-72  
    Types.....7.1-72

F

Foundations, elastic stress.....7.1-162  
    See Stresses and pressures.  
Frost, regional penetration.....7.1-39

G

Glossary.....7.1-G-1

I

Isotropic foundations.....7.1-162  
    See Stresses, Elastic, Semi-infinite.

L

Laboratory tests and test  
properties.....7.1-117

M

Mohr's circle of stress.....7.1-161

P

Pore pressure analysis.....7.1-333  
    See Stability analysis.  
Pressure distribution.....7.1-161  
Pressure on buried structures .....7.1-161  
    Shafts, vertical.....7.1-198  
        In clay.....7.1-198  
        In sand.....7.1-198  
    Shallow pipes and conduits.....7.1-181  
        Conduits beneath embankments.....7.1-190  
            Joint rotation.....7.1-192  
            Longitudinal extension.....7.1-192  
            Selection of pipe.....7.1-192  
        Pipe, concrete.....7.1-184  
        Pipe, flexible steel.....7.1-188  
    Tunnels.....7.1-192  
        In cohesionless soil.....7.1-196  
        In cohesive soil.....7.1-196  
            Pressures during  
                construction.....7.1-198  
            Pressures following  
                construction.....7.1-198  
        In rock.....7.1-194

R

Reservoir impermeabilization.....7.1-286  
    See Seepage and drainage,  
    Reservoirs.

Rock:

Classification and description  
(see Soil and rock  
classification, Rock).....7.1-19

S

Sampling.....7.1-73  
See Exploration and sampling

Sand drains, vertical.....7.1-246  
See Settlement, Reducing or  
accelerating.

Seepage and drainage analysis.....7.1-259

Applications.....7.1-259

Drainage at intermediate  
depths.....7.1-282

Electro-osmosis.....7.1-283

Methods.....7.1-279

Construction controls.....7.1-282

Settlement effects.....7.1-282

Sheeted sumps.....7.1-282

Wellpoint systems.....7.1-279

Analysis.....7.1-282

Applicability.....7.1-282

Capacity.....7.1-282

Drainage, deep.....7.1-279

Methods.....7.1-283

Pumping wells.....7.1-283

Applications.....7.1-283

Special methods.....7.1-283

Relief wells.....7.1-283

Analysis.....7.1-283

Applications.....7.1-283

Drainage, shallow, and  
pressure relief.....7.1-275

Blanket, shallow  
drainage.....7.1-275

Capacity of drainage.....7.1-275

Permeability.....7.1-275

Intercepting drains.....7.1-279

Seepage and drainage analysis

(continued)

Drainage, shallow, and pressure relief (continued)	
Protective filters.....	7.1-271
Investigations required.....	7.1-259
Reservoir impermeabilization.....	7.1-286
Seepage analysis.....	7.1-259
Flow net.....	7.1-259
Groundwater pressures.....	7.1-259
Seepage quantity.....	7.1-262
Three-dimensional flow.....	7.1-263
Seepage control by cutoff.....	7.1-263
Grouted cutoff.....	7.1-271
Impervious soil barriers.....	7.1-271
Methods.....	7.1-263
Sheet piling.....	7.1-263
Applicability.....	7.1-263
Penetration required.....	7.1-267
Supplementary measures.....	7.1-267
<u>Settlement analysis</u> .....	7.1-205
Accelerating, settlements methods.....	7.1-241
See Reducing or accelerating.	
Computation of settlement.....	7.1-210
Differential settlement.....	7.1-238
Structure rigidity effect.....	7.1-241
Values, approximate.....	7.1-238
Tolerable settlement of structures.....	7.1-238
Reduction of differential settlement.....	7.1-238
Structural criteria.....	7.1-238
Consolidation mechanics.....	7.1-205
Reducing or accelerating settlement methods.....	7.1-241
Balancing load by excavation.....	7.1-244
Computation of total settlement.....	7.1-244
Dewatering effect.....	7.1-244
Preconsolidation by surcharge.....	7.1-244
Elimination of primary consolidation.....	7.1-244
Elimination of secondary compression.....	7.1-246
Limitations on surcharge.....	7.1-246
Removal of compressible soil.....	7.1-241
Displacement.....	7.1-244
Excavation.....	7.1-244
Sand drains, vertical.....	7.1-246
Allowance for smear and disturbance.....	7.1-246
Characteristics.....	7.1-246
Consolidation rate.....	7.1-246
Construction control	



requirements.....	7.1-253
Design requirements,	
general.....	7.1-253
Sand drains plus surcharge.....	7.1-253
Stress conditions analysis.....	7.1-205
Initial stresses.....	7.1-205
Added stresses computation.....	7.1-209
Existing conditions	
evaluation.....	7.1-209
Preconsolidation.....	7.1-209
Underconsolidation.....	7.1-209
Swell magnitude.....	7.1-253
Cause.....	7.1-253
Changes in capillary	
stresses.....	7.1-255
Reduction of overburden.....	7.1-254
Time rate of settlement.....	7.1-226
Applications.....	7.1-226
Compression, secondary.....	7.1-231
Combining secondary	
and primary consolidation.....	7.1-231
Computation of settlement.....	7.1-231
Consolidation, primary.....	7.1-223
Gradual load application.....	7.1-231
Prediction accuracy.....	7.1-226
Pressure distribution	
effect.....	7.1-226
Two-layer system consolidation.....	7.1-231
Shafts, vertical.....	7.1-198
See Pressures on buried	
structures.	

Slopes:	
Embankment, protection.....	7.1-338
Stabilization (see	
Stability analysis,	
Slope).....	7.1-335
<u>Soil and rock classification</u> .....	7.1-1
Rock classification and	
description.....	7.1-19
Soil deposits, principal.....	7.1-1
Alluvial deposits.....	7.1-3
Geologic origins.....	7.1-1
Major soil divisions.....	7.1-2
Organic deposits.....	7.1-2
Soil identification.....	7.1-7
Appearance and structure.....	7.1-7
Compactness.....	7.1-7
Field classification.....	7.1-7
Special materials.....	7.1-34
Expansive soils.....	7.1-34
Collapsing soils.....	7.1-39
Permafrost.....	7.1-39
Limestone.....	7.1-39
Quick clays.....	7.1-44
Unified soil classification	
system.....	7.1-9
Utilization.....	7.1-15
<u>Stability analysis</u> .....	7.1-309
Applications.....	7.1-309
Failure varieties.....	7.1-309
Materials, special problems.....	7.1-335
Loessial silts and fine	
sands.....	7.1-335
Overconsolidated,	
fissured clays.....	7.1-335
Cut slopes and	
analysis.....	7.1-335
Old slide masses.....	7.1-335
Saturated, loose sands.....	7.1-335
Talus.....	7.1-335
Methods of analysis.....	7.1-314
Effective stress.....	7.1-333
Procedures.....	7.1-314
Earthquake loading.....	7.1-329
Embankments on soft	
clay.....	7.1-318
Rotational failures.....	7.1-318
Safety factor required.....	7.1-318
Translation failure.....	7.1-318
Total stress.....	7.1-331
Pore Pressure analysis.....	7.1-333
Construction pore	
pressures.....	7.1-333
Seepage pressures.....	7.1-333
Slope Stabilization.....	7.1-335
Methods.....	7.1-335
Regrading.....	7.1-335
Retaining structures.....	7.1-338
<u>Stresses and pressure distribution</u> .....	7.1-161
Elastic foundations stress	
distribution.....	7.1-162

Layered or anisotropic foundations.....	7.1-175
Semi-infinite, isotropic foundations.....	7.1-162
Assumed conditions.....	7.1-162
Horizontal stresses.....	7.1-175
Shear stresses.....	7.1-175
Vertical stresses beneath irregular loads.....	7.1-163
Vertical stresses beneath regular loads.....	7.1-163
Point stress conditions.....	7.1-161
Effective and neutral stresses.....	7.1-161
Applied Load.....	7.1-162
Effective stress.....	7.1-162
Mohr's circle of stress.....	7.1-161
State of stress.....	7.1-161
Swell magnitude.....	7.1-253
See Settlement analysis, Swell.	
Symbols.....	7.1-S-1

T

Tests, exploration and sampling.....	7.1-49
See Exploration and sampling.	
<u>Tests, field, and measurements</u> .....	7.1-49
Field instrumentation.....	7.1-110
Loads.....	7.1-112
Movement, horizontal.....	7.1-110
Movement, vertical.....	7.1-110
Pressures, groundwater.....	7.1-93
Hydrostatic conditions.....	7.1-93
Hydrostatic excess pressures.....	7.1-93
Temperature.....	7.1-112

Tests, field, and measurements (continued)	
Measurement of soil properties	
in situ.....	7.1-97
In-place density.....	7.1-109
Penetration resistance.....	7.1-85
Permeability.....	7.1-103
Borehole permeability	
tests.....	7.1-103
Pumping test.....	7.1-108
Variable head permeability	
test.....	7.1-108
Shear strength.....	7.1-97
<u>Tests, laboratory, and test</u>	
<u>properties.....</u>	7.1-117
Compacted soils tests.....	7.1-153
California bearing ratio.....	7.1-154
Moisture-density	
relationships.....	7.1-153
Proctor test, modified.....	7.1-154
Proctor test, standard.....	7.1-154
Structural properties.....	7.1-154
Consolidation tests.....	7.1-139
Coefficient of consolidation.....	7.1-143
Determination.....	7.1-143
Values, approximate.....	7.1-143
Compression, secondary.....	7.1-143
Organic materials.....	7.1-143
Values, approximate.....	7.1-143
Pressure, preconsolidation.....	7.1-141
Determination.....	7.1-141
Values, approximate.....	7.1-141
Recompression and swell.....	7.1-141
Index, recompression.....	7.1-143
Index, swelling.....	7.1-141
Sample disturbance.....	7.1-143
Utilization.....	7.1-138
Loading sequence.....	7.1-138
Equipment, laboratory.....	7.1-117
Index properties tests.....	7.1-134
Atterberg limits.....	7.1-137
Gradation.....	7.1-137
Moisture content, unit	
weight, specific	
gravity.....	7.1-134
Permeability tests.....	7.1-137
Selection of test for	
design.....	7.1-117
Shear strength tests.....	7.1-145
Laboratory shear tests.....	7.1-145
Direct shear test.....	7.1-145
Triaxial shear test.....	7.1-145
Unconfined compression	
test.....	7.1-145
Selection of test.....	7.1-148
Tunnels, pressures on buried	
structures.....	7.1-192
See Pressures on buried	
structures, tunnels.	